

Стоматологическая лаборатория HWL, HSL, HSC, HSN, HSH, HSB, HWN, HWC, HTL, SW

Описание

По вопросам продаж и поддержки обращайтесь:

Алматы (727)345-47-04
Ангарск (3955)60-70-56
Архангельск (8182)63-90-72
Астрахань (8512)99-46-04
Барнаул (3852)73-04-60
Белгород (4722)40-23-64
Благовещенск (4162)22-76-07
Брянск (4832)59-03-52
Владивосток (423)249-28-31
Владикавказ (8672)28-90-48
Владимир (4922)49-43-18
Волгоград (844)278-03-48
Вологда (8172)26-41-59
Воронеж (473)204-51-73
Екатеринбург (343)384-55-89

Иваново (4932)77-34-06
Ижевск (3412)26-03-58
Иркутск (395)279-98-46
Казань (843)206-01-48
Калининград (4012)72-03-81
Калуга (4842)92-23-67
Кемерово (3842)65-04-62
Киров (8332)68-02-04
Коломна (4966)23-41-49
Кострома (4942)77-07-48
Краснодар (861)203-40-90
Красноярск (391)204-63-61
Курск (4712)77-13-04
Курган (3522)50-90-47
Липецк (4742)52-20-81

Магнитогорск (3519)55-03-13
Москва (495)268-04-70
Мурманск (8152)59-64-93
Набережные Челны (8552)20-53-41
Нижний Новгород (831)429-08-12
Новокузнецк (3843)20-46-81
Ноябрьск (3496)41-32-12
Новосибирск (383)227-86-73
Омск (3812)21-46-40
Орел (4862)44-53-42
Оренбург (3532)37-68-04
Пенза (8412)22-31-16
Петрозаводск (8142)55-98-37
Псков (8112)59-10-37
Пермь (342)205-81-47

Ростов-на-Дону (863)308-18-15
Рязань (4912)46-61-64
Самара (846)206-03-16
Санкт-Петербург (812)309-46-40
Саратов (845)249-38-78
Севастополь (8692)22-31-93
Саранск (8342)22-96-24
Симферополь (3652)67-13-56
Смоленск (4812)29-41-54
Сочи (862)225-72-31
Ставрополь (8652)20-65-13
Сургут (3462)77-98-35
Сыктывкар (8212)25-95-17
Тамбов (4752)50-40-97
Тверь (4822)63-31-35

Тольятти (8482)63-91-07
Томск (3822)98-41-53
Тула (4872)33-79-87
Тюмень (3452)66-21-18
Ульяновск (8422)24-23-59
Улан-Удэ (3012)59-97-51
Уфа (347)229-48-12
Хабаровск (4212)92-98-04
Чебоксары (8352)28-53-07
Челябинск (351)202-03-61
Череповец (8202)49-02-64
Чита (3022)38-34-83
Якутск (4112)23-90-97
Ярославль (4852)69-52-93

Россия +7(495)268-04-70

Казахстан +7(727)345-47-04

Беларусь +(375)257-127-884

Узбекистан +998(71)205-18-59

Киргизия +996(312)96-26-47

эл.почта: hws@nt-rt.ru || сайт: <https://hammacher.nt-rt.ru/>

HWL 039-07, Modelling instrument

Category: Wax and modelling instruments

Order number: HWL_039-07



MasterLine, Hammacher-Hoyer, Beale No. 7

HWL 038-03, Modelling instrument

Category: Wax and modelling instruments

Order number: HWL_038-03



MasterLine, Hammacher-Hoyer, Zahle

HWL 037-00, Modelling instrument

Category: Wax and modelling instruments

Order number: HWL_037-00



MasterLine, Hammacher-Hoyer

HWL 036-00, Modelling instrument

Category: Wax and modelling instruments

Order number: HWL_036-00



MasterLine, Hammacher-Hoyer, Discoid-Cleoid fig. 89/92

HWL 035-00, Modelling instrument

Category: Wax and modelling instruments

Order number: HWL_035-00



MasterLine, Hammacher-Hoyer, Le Cron

HWL 034-06, Modelling instrument

Category: Wax and modelling instruments

Order number: HWL_034-06



MasterLine, Hammacher-Hoyer, P.K. Thomas, fig. 6

HWL 033-03, Modelling instrument

Category: Wax and modelling instruments

Order number: HWL_033-03



MasterLine, Hammacher-Hoyer, P.K. Thomas, fig. 3

HWL 032-02, Modelling instrument

Category: Wax and modelling instruments

Order number: HWL_032-02



MasterLine, Hammacher-Hoyer, P.K. Thomas, fig. 2

HWL 031-01, Modelling instrument

Category: Wax and modelling instruments

Order number: HWL_031-01



MasterLine, Hammacher-Hoyer, P.K. Thomas, fig. 1

HWL 030-00, Modelling instrument

Category: Wax and modelling instruments

Order number: HWL_030-00



MasterLine, Hammacher-Hoyer, modelling set for the technician with 9 instruments

HWL 010-05, Mixing spatula

Category: Wax and modelling instruments

Order number: HWL_010-05



No. 5, from WIRONIT steel

HSL 147-00, Wax-up brush

Category: Wax and modelling instruments

Order number: HSL_147-00



Double ended, one side pure squirrel hair, second side bristles

HSL 119-17, Wax knife

Category: Wax and modelling instruments

Order number: HSL_119-17



Lessmann, 175 mm, stainless, black wooden handle

HSL 118-13, Wax knife

Category: Wax and modelling instruments

Order number: HSL_118-13



Lessmann, 130 mm, stainless, black wooden handle

HSL 115-17, Wax knife

Category: Wax and modelling instruments

Order number: HSL_115-17



Fahnenstock, 175 mm

HSL 112-13, Wax knife

Category: Wax and modelling instruments

Order number: HSL_112-13



Fahnenstock, 130 mm

HSL 110-00, Wax knife

Category: Wax and modelling instruments

Order number: HSL_110-00



Antkoviak, Wax knife with wooden handle

HSL 062-07, Modelling instrument

Category: Wax and modelling instruments

Order number: HSL_062-07



no. 7, Beale

HSL 061-00, Modelling instrument

Category: Wax and modelling instruments

Order number: HSL_061-00



HSL 059-02, Modelling instrument

Category: Wax and modelling instruments

Order number: HSL_060-03



Zahle

HSL 059-02, Modelling instrument

Category: Wax and modelling instruments

Order number: HSL_059-02



Zahle

HSL 058-01, Modelling instrument

Category: Wax and modelling instruments

Order number: HSL_058-01



Zahle

HSL 056-00, Modelling instrument

Category: Wax and modelling instruments

Order number: HSL_056-00



Ermert, all metall

HSL 055-00, Modelling instrument

Category: Wax and modelling instruments

Order number: HSL_055-00



Hylin-Le Cron

HSL 053-00, Modelling instrument

Category: Wax and modelling instruments

Order number: HSL_053-00



HSL 051-17, Modelling instrument

Category: Wax and modelling instruments

Order number: HSL_052-17



Le Cron

HSL 049-02, Modelling instrument

Category: Wax and modelling instruments

Order number: HSL_049-02



no. 2, Crown and bridge instrument

HSL 049-01, Modelling instrument

Category: Wax and modelling instruments

Order number: HSL_049-01



no. 1, Crown and bridge instrument

HSL 038-00, Modelling instrument

Category: Wax and modelling instruments

Order number: HSL_038-00



Colour instruments, for composite material

HSL 037-00, Modelling instrument

Category: Wax and modelling instruments

Order number: HSL_037-00



Colour instruments, for composite material

HSL 036-07, Wax and modelling carver

Category: Wax and modelling instruments

Order number: HSL_036-07



no. 7, with coloured handles

HSL 035-01, Wax and modelling carver

Category: Wax and modelling instruments

Order number: HSL_035-01



Ward, fig. 1S, with coloured handles

HSL 033-00, Wax and modelling carver

Category: Wax and modelling instruments

Order number: HSL_033-00



Zahle, with coloured handles

HSL 032-00, Wax and modelling carver

Category: Wax and modelling instruments

Order number: HSL_032-00



Zahle, with coloured handles

HSL 031-00, Wax and modelling carver

Category: Wax and modelling instruments

Order number: HSL_031-00



Zahle, with coloured handles

HSL 030-00, Wax and modelling carver

Category: Wax and modelling instruments

Order number: HSL_030-00



Zahle, with coloured handles

HSL 029-00, Wax and modelling carver

Category: Wax and modelling instruments

Order number: HSL_029-00



Zahle, with coloured handles

HSC 520-15, Smart Grip

Category: Special holding clip

Order number: HSL_520-15



Smart Grip, Kraus, 155 mm Special holding clip for all-ceramic

HSC 518-14, Smart Clip

Category: Special holding clip

Order number: HSC_518-14



Kraus, special holding clip, 135 mm The special holding clip is suitable optimally for painting, glazing and the final etching of full ceramic parts such as inlays, partial crown, veneers, crown for canines and incisors.

HSN 225-08, Spatula knife

Category: Spatulas

Order number: HSN_225-08



flexible, L = 180 mm, SL = 80 mm

HSN 200-18, Mixing spatula

Category: Spatulas

Order number: HSN_200-08



flexible/elastic, L = 160 mm, SL = 80 mm

HSH 563-00, Glass spatula

Category: Spatulas

Order number: HSH_563-00



L=100mm

HSL 600-00, Set of instruments for ceramics

Category: Sets

Order number: HSL_600-00



Complete set for ceramicians ""First""

HSL 595-00, Set of instruments for ceramics

Category: Sets

Order number: HSL_595-00



Set of instruments for ceramics according to Greenstein

HSL 585-00, Set of instruments for ceramics

Category: Sets

Order number: HSL_585-00



Set of instruments for ceramics according to Greenstein

HSL 550-00, Ceramic Set

Category: Sets

Order number: HSL_550-00



Ceramic Set 2000 in wooden case

HSL 536-01, Set of technical pliers

Category: Sets

Order number: HSL_536-01

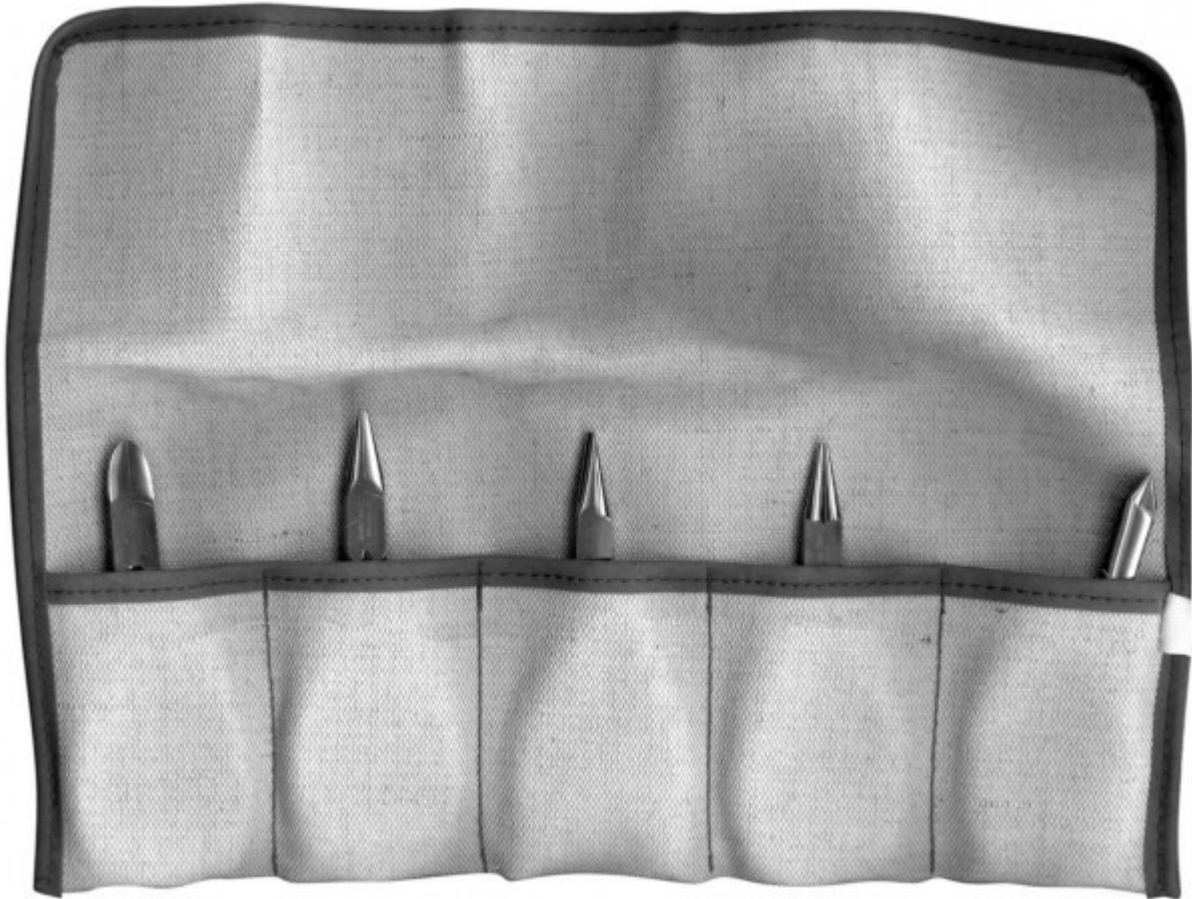

Case of set of technical pliers

HSL 536-00, Set of technical pliers

Category: Sets

Order number: HSL_536-00

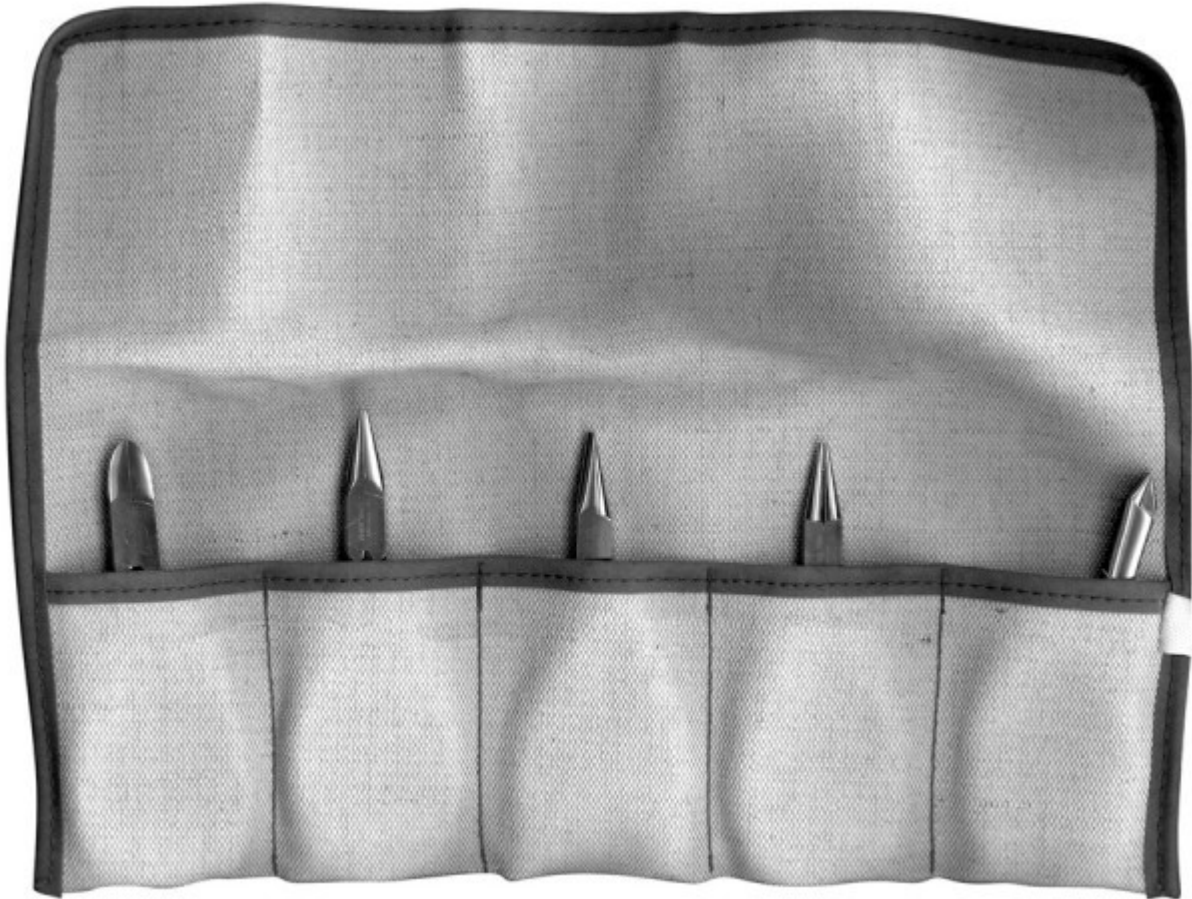

Set of 5 technical pliers (HSL 536-10 - HSL 536-50) Econo Etui

HSL 535-00, Technicians set

Category: Sets

Order number: HSL_535-00



Technicians set

HSL 518-19, Plate and wire shear

Category: Scissors

Order number: HSL_518-19



190 mm

HSL 516-14, Plate and wire shear

Category: Scissors

Order number: HSL_516-14



145 mm

HSL 512-17, Plate and wire shear

Category: Scissors

Order number: HSL_512-17



170 mm, toothed, curved, lacquered

HSL 510-17, Plate and wire shear

Category: Scissors

Order number: HSL_510-17



170 mm, toothed, straight, lacquered

HSL 509-17, Plate and wire shear

Category: Scissors

Order number: HSL_509-17



170 mm, toothed, curved, lacquered

HSL 508-17, Plate and wire shear

Category: Scissors

Order number: HSL_508-17



170 mm, toothed, straight, lacquered

HSB 665-11, Plate and wire shear

Category: Scissors

Order number: HSB_665-11



115 mm, curved

HSB 664-11, Plate and wire shear

Category: Scissors

Order number: HSB_664-11



115 mm, straight

HSB 663-09, Plate and wire shear

Category: Scissors

Order number: HSB_663-09



90 mm, curved

HSB 662-09, Plate and wire shear

Category: Scissors

Order number: HSB_662-09



90 mm, straight

HSB 661-12, Crown and collar scissors

Category: Scissors

Order number: HSB_661-12



Universal, 120 mm, with TC inserts

HSB 659-12, Plate and wire shear

Category: Scissors

Order number: HSB_659-12



Universal, 120 mm, saw edge

HSB 653-10, Plate and wire shear

Category: Scissors

Order number: HSB_653-10



Spezial, 100 mm, curved

HSB 643-12, Crown and collar scissors

Category: Scissors

Order number: HSB_643-12



120 mm, sharp, saw edge, curved

HSB 641-12, Crown and collar scissors

Category: Scissors

Order number: HSB_641-12

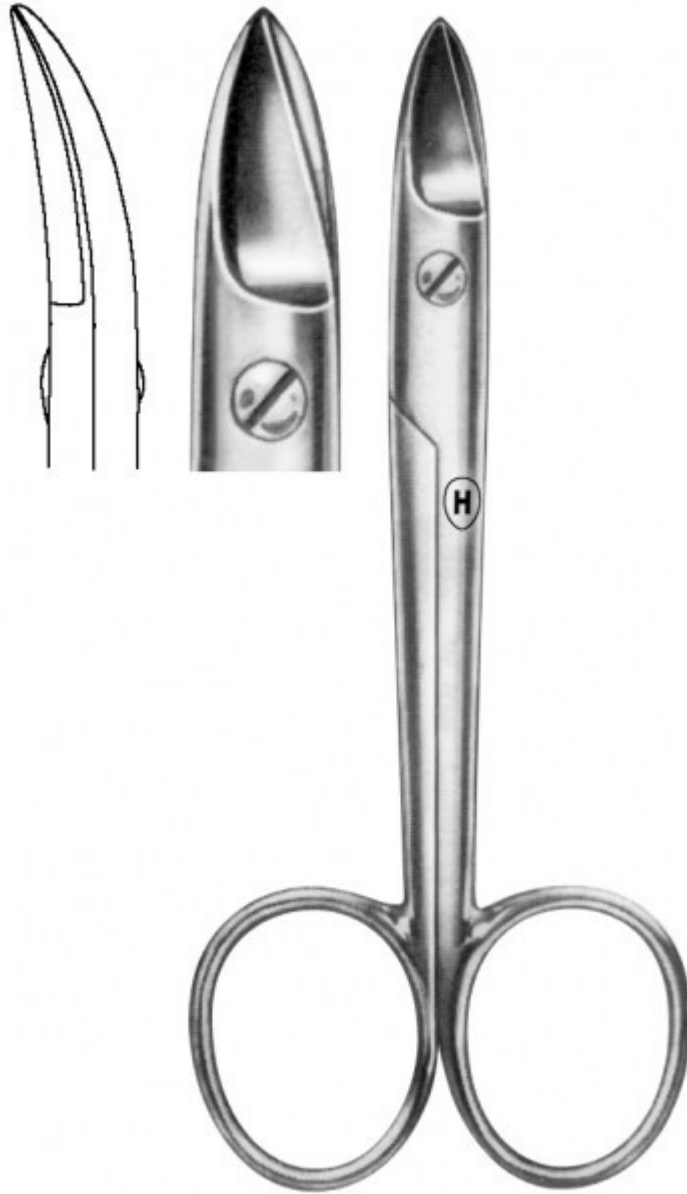

120 mm sharp, curved

HSB 640-12, Crown and collar scissors

Category: Scissors

Order number: HSB_640-12

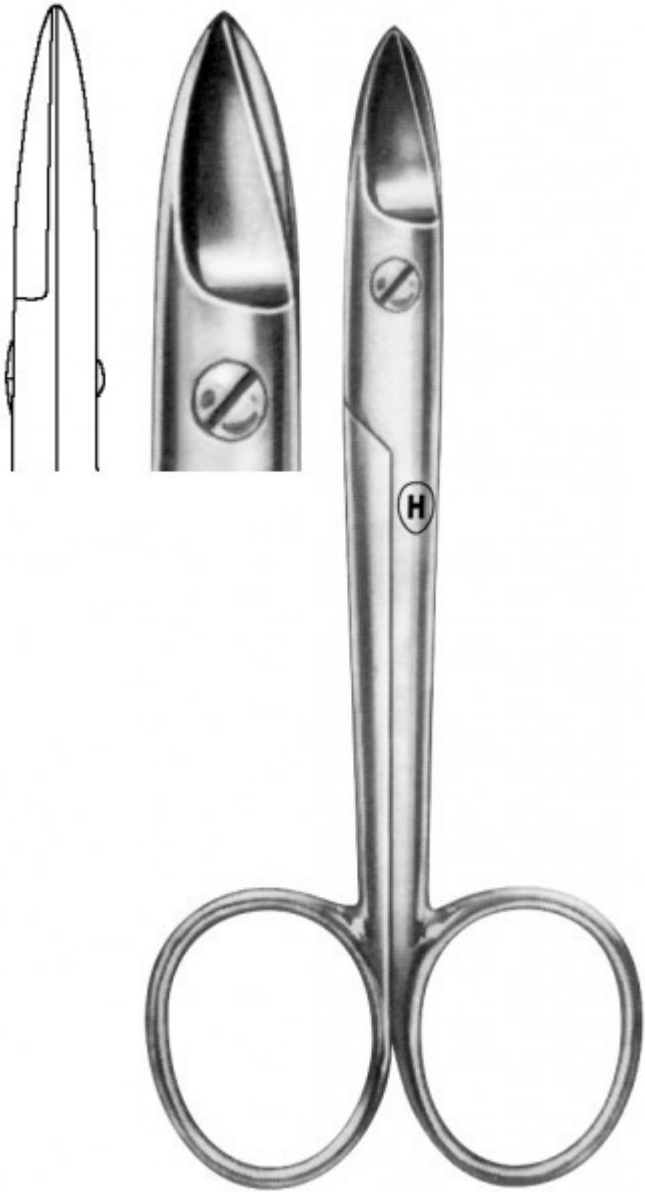

120 mm, sharp, straight

HSB 638-09, Scissors for thermoforming

Category: Scissors

Order number: HSB_638-09



95 mm, curved, with micro serration

HSB 636-25, Paper scissors

Category: Scissors

Order number: HSB_636-25



250 mm, nickel plated

HSB 634-11, Pocket scissors

Category: Scissors

Order number: HSB_634-11



115 mm

HSB 630-10, Scissors for foils and splints

Category: Scissors

Order number: HSB_630-10



105 mm, curved, with micro saw edge, stainless

HSB 624-16, Laboratory scissors

Category: Scissors

Order number: HSB_624-16



160 mm, nickel plated

HSB 622-14, Laboratory scissors

Category: Scissors

Order number: HSB_622-14



145 mm, nickel plated

HSB 620-13, Laboratory scissors

Category: Scissors

Order number: HSB_620-13



130 mm, nickel plated

HSB 604-18, Scissors

Category: Scissors

Order number: HSB_604-18

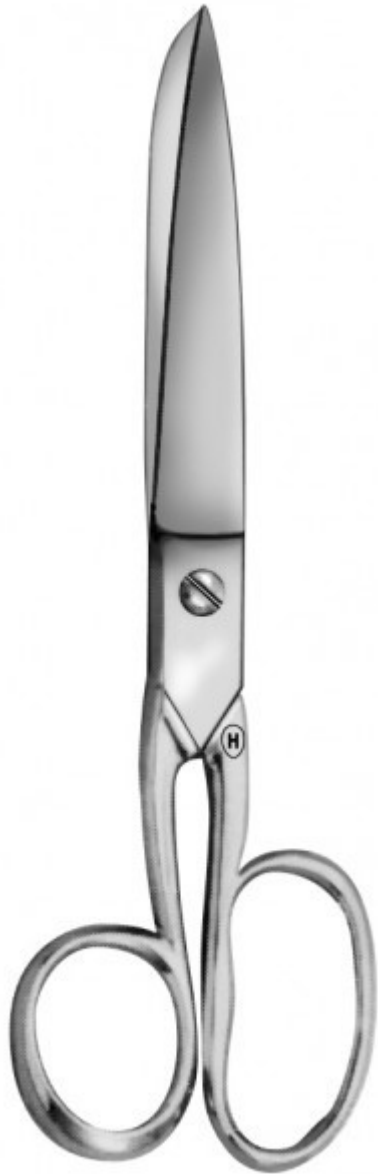

180 mm, for left hand, heavy model, nickel plated

HSB 598-18, Laboratory scissors

Category: Scissors

Order number: HSB_598-18



180 mm, chromium plated

HSB 596-20, Laboratory scissors

Category: Scissors

Order number: HSB_596-20



200 mm, stainless

HSB 594-18, Laboratory scissors

Category: Scissors

Order number: HSB_594-18



180 mm, stainless

HSB 588-20, Scissors

Category: Scissors

Order number: HSB_588-20



200 mm

HSB 586-18, Laboratory scissors

Category: Scissors

Order number: HSB_586-18



180 mm

HSB 584-15, Laboratory scissors

Category: Scissors

Order number: HSB_584-15



150 mm

HSB 582-12, Laboratory scissors

Category: Scissors

Order number: HSB_582-12



120 mm

HSB 579-18, Bandage scissors

Category: Scissors

Order number: HSB_579-18



180 mm, with tungsten carbide inserts

HSB 018-11, Foil scissors

Category: Scissors

Order number: HSB_018-11



straight, with micro-serration

HSL 686-03, Fret saw blades

Category: Saws

Order number: HSL_686-03



fig. 3, for plaster

HSL 685-02, Fret saw blades

Category: Saws

Order number: HSL_685-02



fig. 2, for plaster

HSL 684-01, Fret saw blades

Category: Saws

Order number: HSL_684-01



fig. 1, for plaster

HSL 681-03, Fret saw blades

Category: Saws

Order number: HSL_681-03



fig. 3, for metal

HSL 680-02, Fret saw blades

Category: Saws

Order number: HSL_680-02



fig. 2, for metal

HSL 679-01, Fret saw blades

Category: Saws

Order number: HSL_679-01



fig. 1, for metal

HSL 678-00, Fret saw blades

Category: Saws

Order number: HSL_678-00

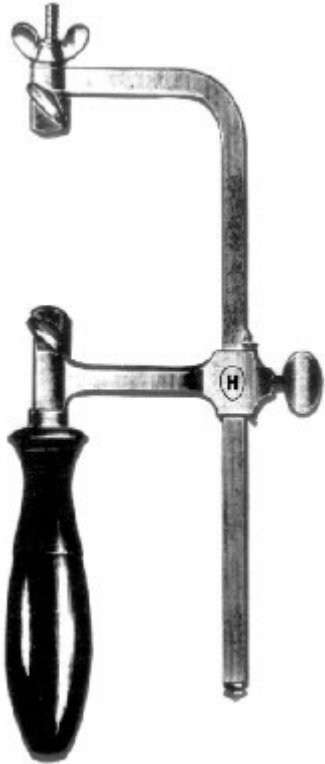

fig. 0, for metal

HSL 676-00, Fret saw frame

Category: Saws

Order number: HSL_676-00



adjustable, with wooden handle, with tension screw

HSL 673-12, Saw blades

Category: Saws

Order number: HSL_673-12



quick cutting, with high flexural strength, 0,12 x 2,8 mm

HSL 672-25, Saw blades

Category: Saws

Order number: HSL_672-25



quick cutting, with high flexural strength, 0,25 x 3 mm

HSL 671-25, Saw blades

Category: Saws

Order number: HSL_671-25



quick cutting, with high flexural strength, 0,25 x 5 mm

HSL 670-12, Saw blades

Category: Saws

Order number: HSL_670-12



quick cutting, with high flexural strength, 0,12 x 5 mm

HSL 669-18, Saw

Category: Saws

Order number: HSL_669-18



Bowed model saw, 180 mm

HSL 668-20, Saw

Category: Saws

Order number: HSL_668-20



Model saw, 200 mm

HSL 661-21, Riveting hammer

Category: Riveting hammers

Order number: HSL_661-21

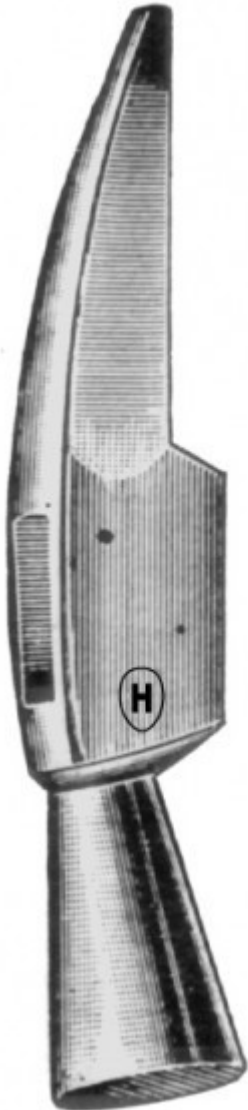

210 mm, 55x9 mm, with wooden handle, flat, normal steel

HSL 660-21, Riveting hammer

Category: Riveting hammers

Order number: HSL_660-21



210 mm, 55 mm, with wooden handle, pointed, normal steel

HSB 800-12, Micro scalpel

Category: Modelling instruments

Order number: HSB_800-12



125 mm, very delicate

HWN 270-21, Mixing spatula

Category: Mixing spatulas

Order number: HWN_270-21



L = 215 mm, SB = 21 mm

HWN 265-15, Micro spatula

Category: Mixing spatulas

Order number: HWN_265-15



150 mm, with metal handle, from WIRONIT steel

HWN 262-15, Section lifter

Category: Mixing spatulas

Order number: HWN_262-15



155 mm, from WIRONIT steel

HWN 261-15, Section lifter

Category: Mixing spatulas

Order number: HWN_261-15



155 mm, from WIRONIT steel

HWN 260-15, Section lifter

Category: Mixing spatulas

Order number: HWN_260-15



155 mm, from WIRONIT steel

HWN 010-00, Micro spoon

Category: Micro spoons

Order number: HWN_010-00



140 mm, single-ended, from WIRONIT steel

HWN 009-05, Micro spatula

Category: Micro spoons

Order number: HWN_009-05



140 mm, single-ended, from WIRONIT steel

HWN 008-04, Micro spatula

Category: Micro spoons

Order number: HWN_008-04



140 mm, single-ended, from WIRONIT steel

HWN 007-05, Micro powder spatula

Category: Micro spoons

Order number: HWN_007-05



140 mm, single-ended, from WIRONIT steel

HWN 006-04, Micro powder spatula

Category: Micro spoons

Order number: HWN_006-04



140 mm, single-ended, from WIRONIT steel

HWN 005-03, Micro powder spatula

Category: Micro spoons

Order number: HWN_005-03



140 mm, single-ended, from WIRONIT steel

HWN 004-05, Micro spatula

Category: Micro spoons

Order number: HWN_004-05



140 mm, single-ended, from WIRONIT steel

HWN 003-04, Micro spatula

Category: Micro spoons

Order number: HWN_003-04



140 mm, single-ended, from WIRONIT steel

HWN 002-03, Micro spatula

Category: Micro spoons

Order number: HWN_002-03



140 mm, single-ended, from WIRONIT steel

HWN 001-02, Micro spatula

Category: Micro spoons

Order number: HWN_001-02



140 mm, single-ended, from WIRONIT steel

HSL 247-10, Measuring instrument

Category: Measuring instruments

Order number: HSL_247-20



Boley, fine tips, curved

HSL 246-00, Measuring calipers

Category: Measuring instruments

Order number: HSL_246-00

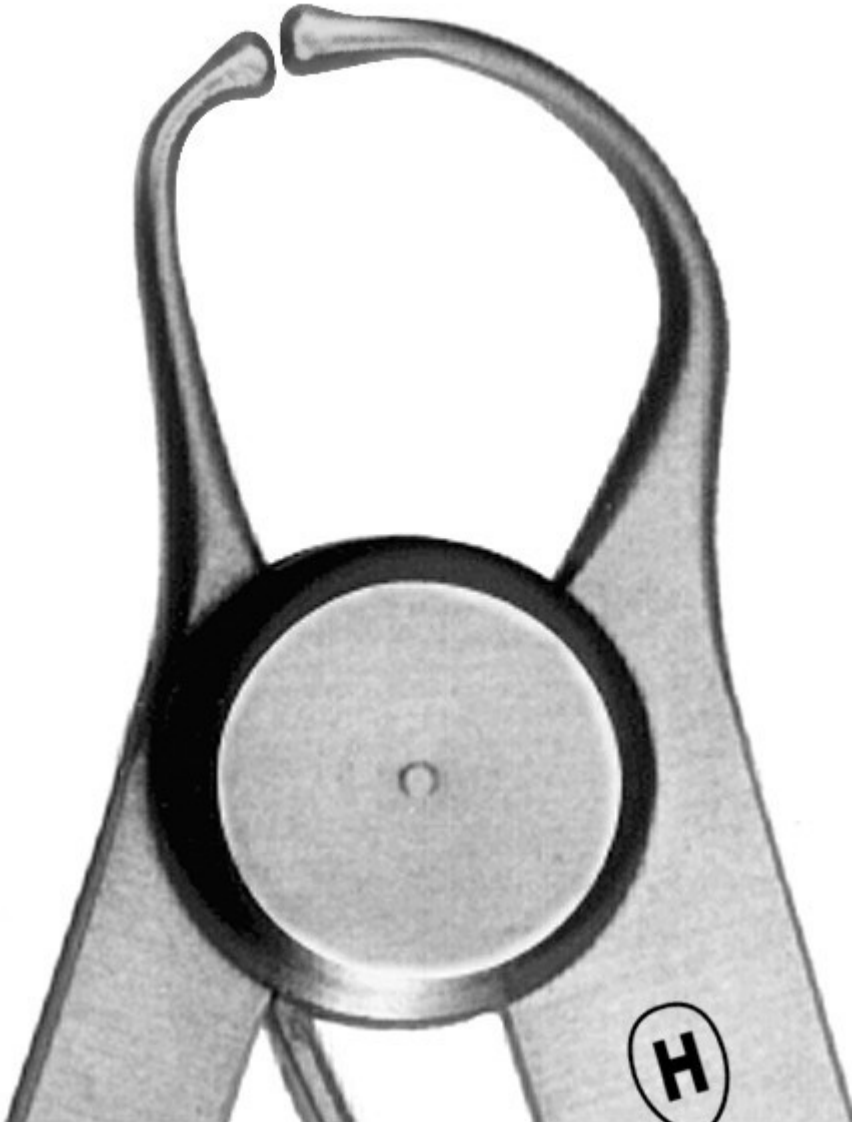

Iwanson, 100 mm, for wax, measuring range 0-10 mm

HSL 245-12, Measuring instrument

Category: Measuring instruments

Order number: HSL_245-12



Interlock Hammacher, measuring range 0 - 10 mm

HSB 837-00, Separating blades

Category: Knives/Scalpels

Order number: HSB_837-00

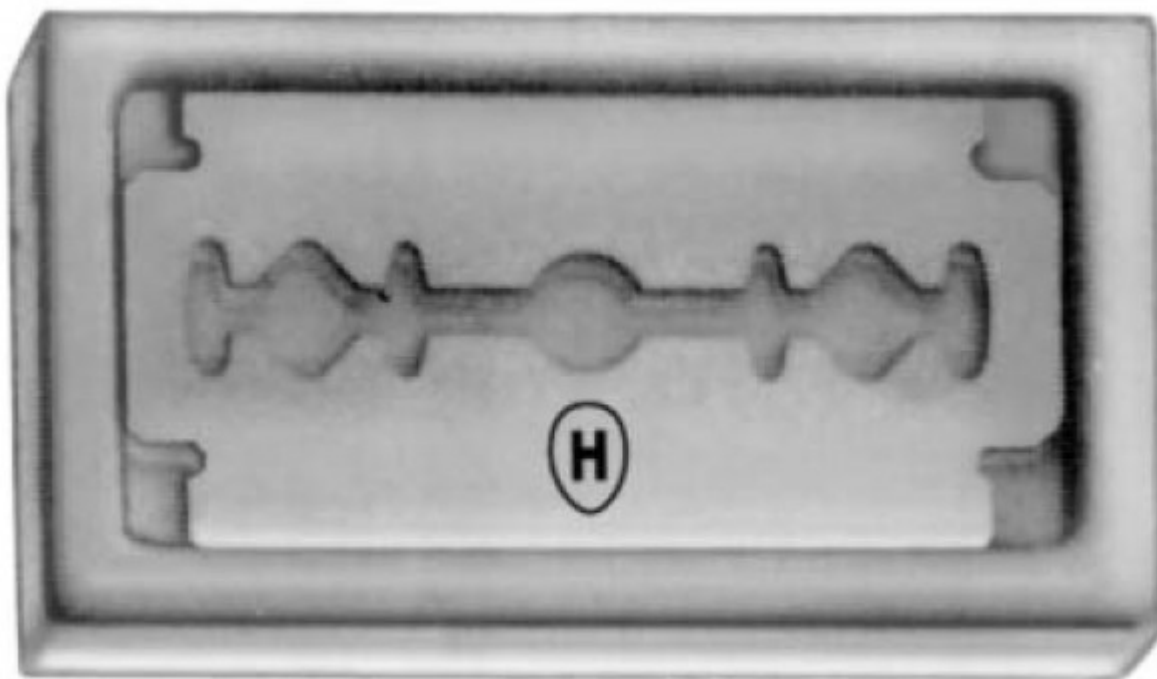

package á 10 pcs.

HSB 805-03, Scalpel handle

Category: Knives/Scalpels

Order number: HSB_805-03



Standard, No. 3, 125 mm

HSB 778-01, Tungsten needle

Category: Knives/Scalpels

Order number: HSB_778-01



Tungsten needle for HSB 777-00

HSB 760-10, Blade for foil knife

Category: Knives/Scalpels

Order number: HSB_760-10



Spare blades for HSB 750-00 (1 pack. = 10 pcs.)

HSB 759-09, Blade for foil knife

Category: Knives/Scalpels

Order number: HSB_759-09



Spare blades for HSB 750-00 (1 pack. = 10 pcs.)

HSB 758-08, Blade for foil knife

Category: Knives/Scalpels

Order number: HSB_758-08



Spare blades for HSB 750-00 (1 pack. = 10 pcs.)

HSB 757-07, Blade for foil knife

Category: Knives/Scalpels

Order number: HSB_757-07



Spare blades for HSB 750-00 (1 pack. = 10 pcs.)

HSB 756-06, Blade for foil knife

Category: Knives/Scalpels

Order number: HSB_756-06



Spare blades for HSB 750-00 (1 pack. = 10 pcs.)

HSB 754-04, Blade for foil knife

Category: Knives/Scalpels

Order number: HSB_754-04



Spare blades for HSB 750-00 (1 pack. = 10 pcs.)

HSB 753-03, Blade for foil knife

Category: Knives/Scalpels

Order number: HSB_753-03



Spare blades for HSB 750-00 (1 pack. = 10 pcs.)

HSB 752-02, Blade for foil knife

Category: Knives/Scalpels

Order number: HSB_752-02



Spare blades for HSB 750-00 (1 pack. = 10 pcs.)

HSB 751-01, Blade for foil knife

Category: Knives/Scalpels

Order number: HSB_751-01



Spare blades for HSB 750-00 (1 pack. = 10 pcs.)

HSB 750-00, Foil knife

Category: Knives/Scalpels

Order number: HSB_750-00



Foil knife with blade HSB 751-01

HSB 748-02, Blade for foil knife

Category: Knives/Scalpels

Order number: HSB_748-02



Spare blades for HSB 746-00 (1 pack. = 10 pcs.)

HSB 747-01, Blade for foil knife

Category: Knives/Scalpels

Order number: HSB_747-01



Spare blades for HSB 746-00 (1 pack. = 10 pcs.)

HSB 746-00, Foil knife

Category: Knives/Scalpels

Order number: HSB_746-00



130 mm

HSB 743-00, Blade for foil knife

Category: Knives/Scalpels

Order number: HSB_743-00



Spare blades for HSB 742-00 (1 pack. = 10 pcs.)

HSB 707-15, Scalpel blades

Category: Knives/Scalpels

Order number: HSB_707-15



fig. 15, not sterile (1 pack. = 50 pcs.)

HSB 705-11, Scalpel blades

Category: Knives/Scalpels

Order number: HSB_705-11



fig. 11, not sterile (1 pack. = 50 pcs.)

HSB 704-10, Scalpel blades

Category: Knives/Scalpels

Order number: HSB_704-10



fig. 10, not sterile (1 pack. = 50 pcs.)

HWL 060-18, Ligature tucker

Category: Ligature instruments

Order number: HWL_060-18



HSL 264-05, Ligature instrument

Category: Ligature instruments

Order number: HSL_264-05



for placing dentalastics

HSL 264-04, Ligature instrument

Category: Ligature instruments

Order number: HSL_264-04



Scaler

HSL 264-03, Ligature tucker

Category: Ligature instruments

Order number: HSL_264-03



with scaler

HSL 264-02, Ligature tucker

Category: Ligature instruments

Order number: HSL_264-02



HSL 264-01, Ligature tucker

Category: Ligature instruments

Order number: HSL_264-01



with band pusher

HSL 264-00, Ligature instrument

Category: Ligature instruments

Order number: HSL_264-00



Band pusher and adhesive remover

HSL 263-18, Ligature instrument

Category: Ligature instruments

Order number: HSL_263-18



adhesive remover

HWC 149-16, Cover glass forceps

Category: Forceps

Order number: HWC_149-16



160 mm, from WIRONIT steel

HWC 148-16, Cover glass forceps

Category: Forceps

Order number: HWC_148-16



160 mm, from WIRONIT steel

HWC 147-10, Cover glass forceps

Category: Forceps

Order number: HWC_147-10



105 mm, from WIRONIT steel

HWC 145-16, Soldering tweezers

Category: Forceps

Order number: HWC_145-16



160 mm, curved tip, from WIRONIT steel

HWC 144-16, Soldering tweezers

Category: Forceps

Order number: HWC_144-16



160 mm, straight tip, from WIRONIT steel

HWC 136-16, Laboratory forceps

Category: Forceps

Order number: HWC_136-16



160 mm, from WIRONIT steel

HWC 135-14, Laboratory forceps

Category: Forceps

Order number: HWC_135-14



140 mm, from WIRONIT steel

HWC 134-12, Laboratory forceps

Category: Forceps

Order number: HWC_134-12



120 mm, from WIRONIT steel

HWC 133-16, Laboratory forceps

Category: Forceps

Order number: HWC_133-16



160 mm, sharp, from WIRONIT steel

HWC 132-14, Laboratory forceps

Category: Forceps

Order number: HWC_132-14



140 mm, sharp, from WIRONIT steel

HWC 131-12, Laboratory forceps

Category: Forceps

Order number: HWC_131-12



120 mm, sharp, from WIRONIT steel

HWC 130-15, Laboratory forceps

Category: Forceps

Order number: HWC_130-15



155 mm, serrated, from WIRONIT steel

HWC 115-10, Micro preparation forceps

Category: Forceps

Order number: HWC_115-10



No. 7, 105 mm, very delicate, curved, from WIRONIT steel

HWC 025-00, Platinum foil folding tweezers

Category: Forceps

Order number: HWC_025-00



from WIRONIT-steel

HWC 016-04, Forceps

Category: Forceps

Order number: HWC_016-04



College, 150 mm, smooth, from WIRONIT steel

HTL 056-19, Solder slide

Category: Forceps

Order number: HTL_056-19



TITAN, 150 mm, with fine tip

HSL 550-99 1 Pair of replacement silicon plates for HSL 548-16 +

Category: Forceps

Order number: HSL_550-99



HSL 549-16 Forceps for Zirkonium works

Category: Forceps

Order number: HSL_549-16



-Zirconium crown holder- Zirconium cap holder- Zirconium scaffold holder- curved-silicon plates for interior and exterior application 7 indiv. adjustable- plus 5 pair of replacement silicon plates

HSL 548-16 Forceps for zirconium works

Category: Forceps

Order number: HSL_548-16



-Zirconium crown holder- Zirconium cap holder- Zirconium scaffold holder- straight -silicon plates for interior and exterior application 7 indiv. adjustable- plus 5 pair of replacement silicon plates

HSL 244-15, Forceps for ceramic work

Category: Forceps

Order number: HSL_244-15



Teleflex Hoyer, 150 mm, with diamond tips

HSL 242-06, Forceps for ceramic work

Category: Forceps

Order number: HSL_242-06



160 mm, curved, with interchangeable diamond tips

HSL 240-02, Crown holding forceps

Category: Forceps

Order number: HSL_240-02



160 mm, curved, with diamond tips

HSC 530-30, Fuel carrier pincers

Category: Forceps

Order number: HSC_530-30



Fuel carrier pincers

HSC 529-16, Soldering tweezers

Category: Forceps

Order number: HSC_529-16



160 mm, curved

HSC 528-16, Soldering tweezers

Category: Forceps

Order number: HSC_528-16



160 mm, straight

HSC 527-16, Soldering tweezers

Category: Forceps

Order number: HSC_527-16



160 mm, with insulated handles, self retaining

HSC 526-16, Soldering tweezers

Category: Forceps

Order number: HSC_526-16



160 mm, with insulated handles, self retaining

HSC 519-17, Crown holding forceps

Category: Forceps

Order number: HSC_519-17



170 mm, diamond tips, adjustable by screw

HSC 517-17, Crown holding forceps

Category: Forceps

Order number: HSC_517-17



170 mm, diamond tips

HSC 516-17, Crown holding forceps

Category: Forceps

Order number: HSC_516-17



170 mm, diamond tips

HSC 511-16, Cover glass forceps

Category: Forceps

Order number: HSC_511-16



160 mm, curved

HSC 510-16, Cover glass forceps

Category: Forceps

Order number: HSC_510-16



160 mm, straight

HSC 064-30, Dressing forceps

Category: Forceps

Order number: HSC_064-30



Standard, 300 mm, straight

HSC 062-25, Dressing forceps

Category: Forceps

Order number: HSC_062-25



Standard, 250 mm, straight

HSC 060-20, Dressing forceps

Category: Forceps

Order number: HSC_060-20



Standard, 200 mm, straight

HSC 058-18, Dressing forceps

Category: Forceps

Order number: HSC_058-18

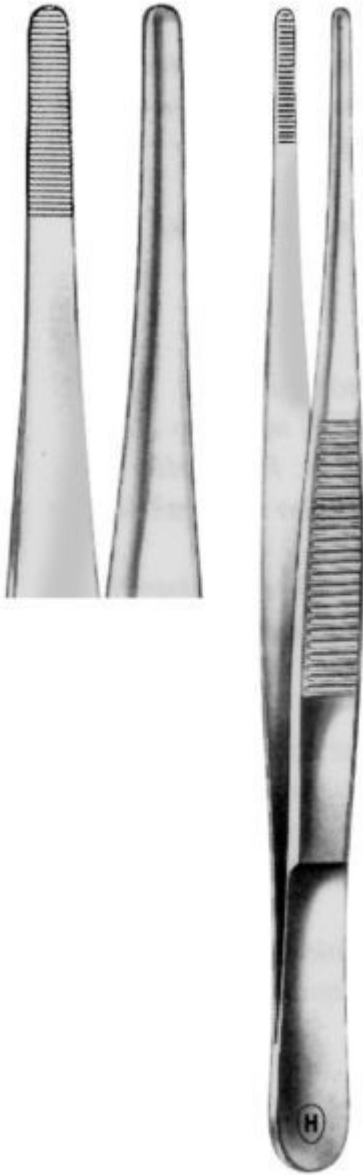

Standard, 180 mm, straight

HSL 614-01, Instrument for ceramics

Category: Ceramic instruments

Order number: HSL_614-01



Carving instrument for ceramics

HSL 612-10, Ceramic brush

Category: Ceramic instruments

Order number: HSL_612-10



Red marder-Kolinsky, fig. 10

HSL 611-08, Ceramic brush

Category: Ceramic instruments

Order number: HSL_611-08



Red marder-Kolinsky, fig. 8

HSL 610-07, Ceramic brush

Category: Ceramic instruments

Order number: HSL_610-07



Red marder-Kolinsky, fig. 7

HSL 609-06, Ceramic brush

Category: Ceramic instruments

Order number: HSL_609-06



Red marder-Kolinsky, fig. 6

HSL 608-05, Ceramic brush

Category: Ceramic instruments

Order number: HSL_608-05



Red marder-Kolinsky, fig. 5

HSL 607-04, Ceramic brush

Category: Ceramic instruments

Order number: HSL_607-04



Red marder-Kolinsky, fig. 4

HSL 606-03, Ceramic brush

Category: Ceramic instruments

Order number: HSL_606-03



Red marder-Kolinsky, fig. 3

HSL 605-02, Ceramic brush

Category: Ceramic instruments

Order number: HSL_605-02



Red marder-Kolinsky, fig. 2

HSL 604-01, Ceramic brush

Category: Ceramic instruments

Order number: HSL_604-01



Red marder-Kolinsky, fig. 1

HSL 603-00, Ceramic brush

Category: Ceramic instruments

Order number: HSL_603-00



Red marder-Kolinsky, fig. 0

HSL 597-02, Instrument for ceramics

Category: Ceramic instruments

Order number: HSL_597-02



Greenstein no. 2, red, with ceramics spatula HSL 593-02

HSL 596-01, Instrument for ceramics

Category: Ceramic instruments

Order number: HSL_596-01



Greenstein, no. 1, gold, with ceramics spatula HSL 592-01

HSL 594-03, Instrument for ceramics

Category: Ceramic instruments

Order number: HSL_594-03



Greenstein, no. 3, spatula, broad, extra fine

HSL 593-02, Instrument for ceramics

Category: Ceramic instruments

Order number: HSL_593-02



Greenstein, no. 2, spatula knife, extra fine

HSL 592-01, Instrument for ceramics

Category: Ceramic instruments

Order number: HSL_592-01



Greenstein, no. 1, spatula, sharp, extra fine

HSL 591-03, Instrument for ceramics

Category: Ceramic instruments

Order number: HSL_591-03



Greenstein, no. 3, spatula, broad

HSL 590-02, Instrument for ceramics

Category: Ceramic instruments

Order number: HSL_590-02



Greenstein, no. 2, spatula knife

HSL 589-01, Instrument for ceramics

Category: Ceramic instruments

Order number: HSL_589-01

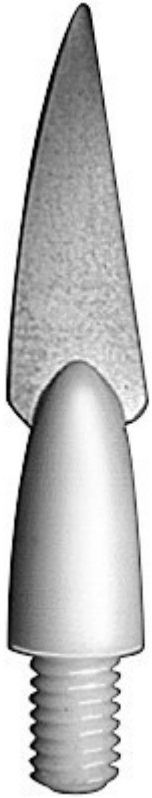

Greenstein, no. 1, spatula, sharp

HSL 588-03, Instrument for ceramics

Category: Ceramic instruments

Order number: HSL_588-03



Greenstein, no. 3, gold, with spring metal blade HSL 591-03

HSL 587-02, Instrument for ceramics

Category: Ceramic instruments

Order number: HSL_587-02



Greenstein, no. 2, red, with spring metal blade HSL 590-02

HSL 579-00, Modelling instrument

Category: Ceramic instruments

Order number: HSL_579-00



knife with extra thin blade

HSL 578-00, Modelling instrument

Category: Ceramic instruments

Order number: HSL_578-00



carver for cutting fissures

HSL 577-00, Modelling instrument

Category: Ceramic instruments

Order number: HSL_577-00



combined instrument with flexible mixing spatula

HSL 576-00, Modelling instrument

Category: Ceramic instruments

Order number: HSL_576-00



double ended, with mixing spatula

HSL 575-00, Modelling instrument

Category: Ceramic instruments

Order number: HSL_575-00



for ceramics

HSL 574-00, Modelling instrument

Category: Ceramic instruments

Order number: HSL_574-00



for ceramics

HSL 573-00, Modelling instrument

Category: Ceramic instruments

Order number: HSL_573-00



for ceramics

HSL 572-00, Modelling instrument

Category: Ceramic instruments

Order number: HSL_572-00



for ceramics

HSL 571-00, Modelling instrument

Category: Ceramic instruments

Order number: HSL_571-00



for ceramics

HSL 562-06, Wax brush

Category: Ceramic instruments

Order number: HSL_562-06



fig. 6, for smoothing of the surfaces

HSL 560-10, Ceramic brush

Category: Ceramic instruments

Order number: HSL_560-10



Red marder, fig. 10

HSL 559-08, Ceramic brush

Category: Ceramic instruments

Order number: HSL_559-08



Red marder, fig. 8

HSL 558-07, Ceramic brush

Category: Ceramic instruments

Order number: HSL_558-07



Red marder, fig. 7

HSL 557-06, Ceramic brush

Category: Ceramic instruments

Order number: HSL_557-06



Red marder, fig. 6

HSL 556-05, Ceramic brush

Category: Ceramic instruments

Order number: HSL_556-05



Red marder, fig. 5

HSL 555-04, Ceramic brush

Category: Ceramic instruments

Order number: HSL_555-04



Red marder, fig. 4

HSL 554-03, Ceramic brush

Category: Ceramic instruments

Order number: HSL_554-03



Red marder, fig. 3

HSL 553-02, Ceramic brush

Category: Ceramic instruments

Order number: HSL_553-02



Red marder, fig. 2

HSL 552-01, Ceramic brush

Category: Ceramic instruments

Order number: HSL_552-01



Red marder, fig. 1

HSL 551-00, Ceramic brush

Category: Ceramic instruments

Order number: HSL_551-00



Red marder, fig. 0

HSC 519-17, Crown holding forceps

Category: Ceramic instruments

Order number: HSC_519-17



170 mm, diamond tips, adjustable by screw

HSC 518-99, Smart Clip

Category: Ceramic instruments

Order number: HSC_518-99



replacement tip

HSC 517-17, Crown holding forceps

Category: Ceramic instruments

Order number: HSC_517-17



170 mm, diamond tips

HSC 011-04, Forceps

Category: Ceramic instruments

Order number: HSC_011-04



parallel gripping, angled

Brush head size 8

Category: Ceramic instruments

Order number: HSL_522-08



Brush Head size 5-8

Category: Ceramic instruments

Order number: HSL_521-71



Brush head size 5

Category: Ceramic instruments

Order number: HSL_522-06



Brush head size 5

Category: Ceramic instruments

Order number: HSL_522-05



Brush head size 4

Category: Ceramic instruments

Order number: HSL_522-04



Brush head size 3

Category: Ceramic instruments

Order number: HSL_522-03



Brush head size 2

Category: Ceramic instruments

Order number: HSL_522-02



Brush head size 1

Category: Ceramic instruments

Order number: HSL_522-01



Brush Head size 0

Category: Ceramic instruments

Order number: HSL_522-00



Brusg head size 6

Category: Ceramic instruments

Order number: SW10011



Brusg head size 6

Category: Ceramic instruments

Order number: SW10010



Brusg head size 6

Category: Ceramic instruments

Order number: SW10009



Brusg head size 6

Category: Ceramic instruments

Order number: HSL_522-07



HWL 109-07, Plaster knife

Category: Plaster knives

Order number: HWL_109-07



Buffalo-Hammacher, no. 7

HWL 108-06, Laboratory knife

Category: Plaster knives

Order number: HWL_108-06



No. 6, Buffalo-Hammacher, from WIRONIT steel

HWL 107-17, Laboratory knife

Category: Plaster knives

Order number: HWL_107-17



170 mm, from WIRONIT steel

HWL 106-17, Laboratory knife

Category: Plaster knives

Order number: HWL_106-17



Gritzman, 170 mm, from WIRONIT steel

HWL 104-17, Laboratory knife

Category: Plaster knives

Order number: HWL_104-17



175 mm, from WIRONIT steel

HWL 103-14, Laboratory knife

Category: Plaster knives

Order number: HWL_103-14



140 mm, from WIRONIT steel

HWL 102-14, Laboratory knife

Category: Plaster knives

Order number: HWL_102-14



140 mm, from WIRONIT steel

HSL 123-18, Laboratory knife

Category: Plaster knives

Order number: HSL_123-18



Hammacher, 180 mm

HSL 123-16, Laboratory knife

Category: Plaster knives

Order number: HSL_123-16



Hammacher, 160 mm

HSL 122-16, Laboratory knife

Category: Plaster knives

Order number: HSL_122-16



Gritman, 165 mm

HSL 121-18, Laboratory knife

Category: Plaster knives

Order number: HSL_121-18



180 mm

HSL 129-13, Mixing bowl

Category: Mixing bowl

Order number: HSL_129-13



of soft rubber

HSN 311-01, Double-lever-stopcock burner

Category: Burner

Order number: HSN_311-01



Double-lever-stopcock burner for naturel gas, Height 155mm

HWL 027-06, Waxing instrument

Category: Waxing instruments

Order number: HWL_027-06



P.K. Thomas, fig. 6

HWL 026-05, Waxing instrument

Category: Waxing instruments

Order number: HWL_026-05



P.K. Thomas, fig. 5

HWL 025-04, Waxing instrument

Category: Waxing instruments

Order number: HWL_025-04



P.K. Thomas, fig. 4

HWL 024-03, Waxing instrument

Category: Waxing instruments

Order number: HWL_024-03



P.K. Thomas, fig. 3

HWL 023-02, Waxing instrument

Category: Waxing instruments

Order number: HWL_023-02



P.K. Thomas, fig. 2

HSL 085-05, Modelling instrument

Category: Waxing instruments

Order number: HSL_085-05



fig. 5, P.K. Thomas, Waxing carver with insulate handle

HSL 084-04, Modelling instrument

Category: Waxing instruments

Order number: HSL_084-04



fig. 4, P.K. Thomas, Waxing carver with insulate handle

HSL 083-03, Modelling instrument

Category: Waxing instruments

Order number: HSL_083-03



fig. 3, P.K. Thomas, Waxing carver with insulate handle

HSL 082-02, Modelling instrument

Category: Waxing instruments

Order number: HSL_082-02



fig. 2, P.K. Thomas, Waxing carver with insulate handle

HSL 081-01, Modelling instrument

Category: Waxing instruments

Order number: HSL_081-01



fig. 1, P.K. Thomas, Waxing carver with insulate handle

HSL 028-05, Waxing instrument

Category: Waxing instruments

Order number: HSL_028-05



P.K. Thomas, fig. 5, with coloured handles

HSL 027-04, Waxing instrument

Category: Waxing instruments

Order number: HSL_027-04



P.K. Thomas, fig. 4, with coloured handles

HSL 026-03, Waxing instrument

Category: Waxing instruments

Order number: HSL_026-03



P.K. Thomas, fig. 3, with coloured handles

HSL 025-02, Waxing instrument

Category: Waxing instruments

Order number: HSL_025-02

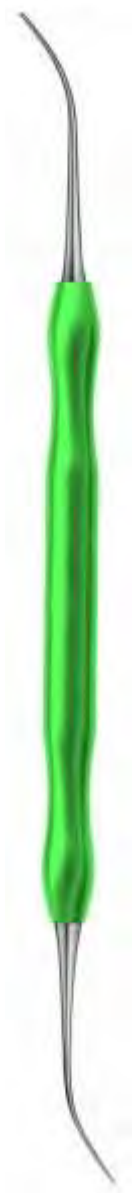

P.K. Thomas, fig. 2, with coloured handles

HSL 024-01, Waxing instrument

Category: Waxing instruments

Order number: HSL_024-01



P.K. Thomas, fig. 1, with coloured handles

HSL 023-15, Set of waxing instruments

Category: Waxing instruments

Order number: HSL_023-15



Consisting of: HSL 024-01, HSL 025-02, HSL 026-03, HSL 027-04, HSL 028-05, with coloured handles

HWN 312-28, Universal holding tong

Category: Pliers

Order number: HWN_312-28



280 mm, dia 4,5 mm, straight, from WIRONIT steel

HWN 302-32, Crucible tong

Category: Pliers

Order number: HWN_302-32



320 mm, dia 5,0 mm, from WIRONIT steel

HWN 301-25, Crucible tong

Category: Pliers

Order number: HWN_301-25



250 mm, dia 4,5 mm, from WIRONIT steel

HWN 300-22, Crucible tong

Category: Pliers

Order number: HWN_300-22



220 mm, dia 4,5 mm, from WIRONIT steel

HSN 338-55, Bulb tong

Category: Pliers

Order number: HSN_338-55



stainless, 550 mm, dia. 6,0 mm

HSN 335-60, Crucible tong

Category: Pliers

Order number: HSN_335-60



stainless, 600 mm, dia. 8,0 mm

HSN 334-50, Crucible tong

Category: Pliers

Order number: HSN_334-50



stainless, 500 mm, dia. 7,0 mm

HSN 333-40, Crucible tong

Category: Pliers

Order number: HSN_333-40



stainless, 400 mm, dia. 6,0 mm

HSN 332-30, Crucible tong

Category: Pliers

Order number: HSN_332-30



stainless, 300 mm, dia. 5,0 mm

HSN 331-25, Crucible tong

Category: Pliers

Order number: HSN_331-25



stainless, 250 mm, dia. 5,0 mm

HSN 330-22, Crucible tong

Category: Pliers

Order number: HSN_330-22



stainless, 220 mm, dia. 4,5 mm

HSL 655-00, Hard plaster nipper

Category: Pliers

Order number: HSL_655-00



springs, stainless, only

HSL 654-19, Hard plaster nipper

Category: Pliers

Order number: HSL_654-19



190 mm, stainless

HSL 653-00, Hard plaster nipper

Category: Pliers

Order number: HSL_653-00



screw, only

HSL 651-00, Hard plaster nipper

Category: Pliers

Order number: HSL_651-00



special lock, spring only

HSL 650-19, Hard plaster nipper

Category: Pliers

Order number: HSL_650-19



Hammacher, 190 mm

HSL 536-50, Wire and clasp bending pliers

Category: Pliers

Order number: HSL_536-50



Aderer, 130 mm, with black plastic coated handles

HSL 536-40, Round nose pliers

Category: Pliers

Order number: HSL_536-40

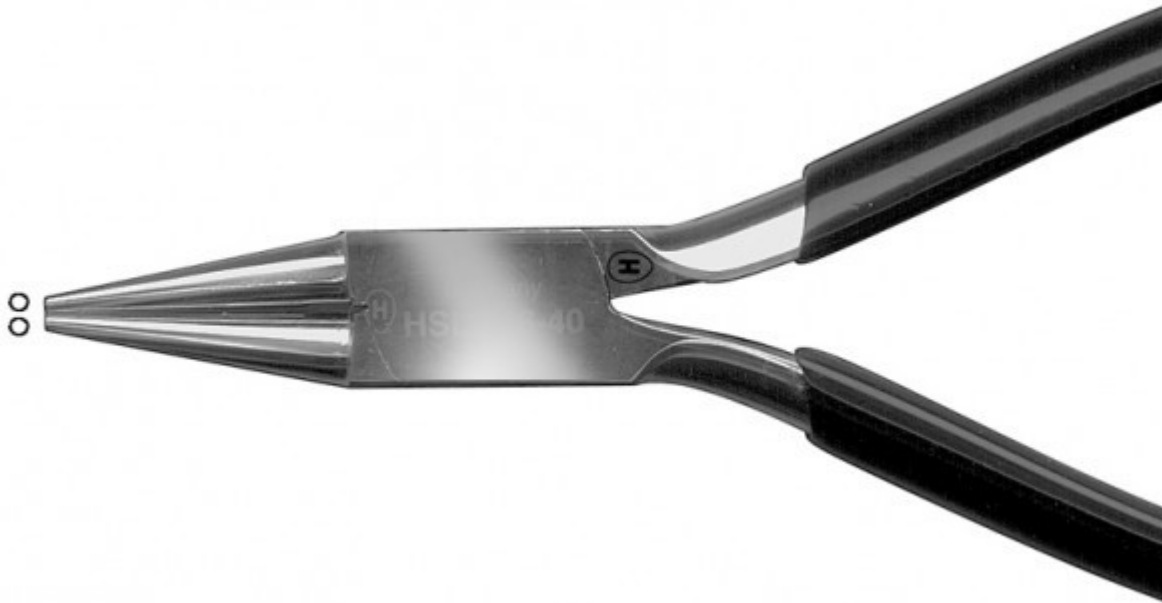

135 mm, with black plastic coated handles

HSL 536-30, Clasp and wire bending pliers

Category: Pliers

Order number: HSL_536-30



135 mm, with black plastic coated handles

HSL 536-20, Flat nose pliers

Category: Pliers

Order number: HSL_536-20

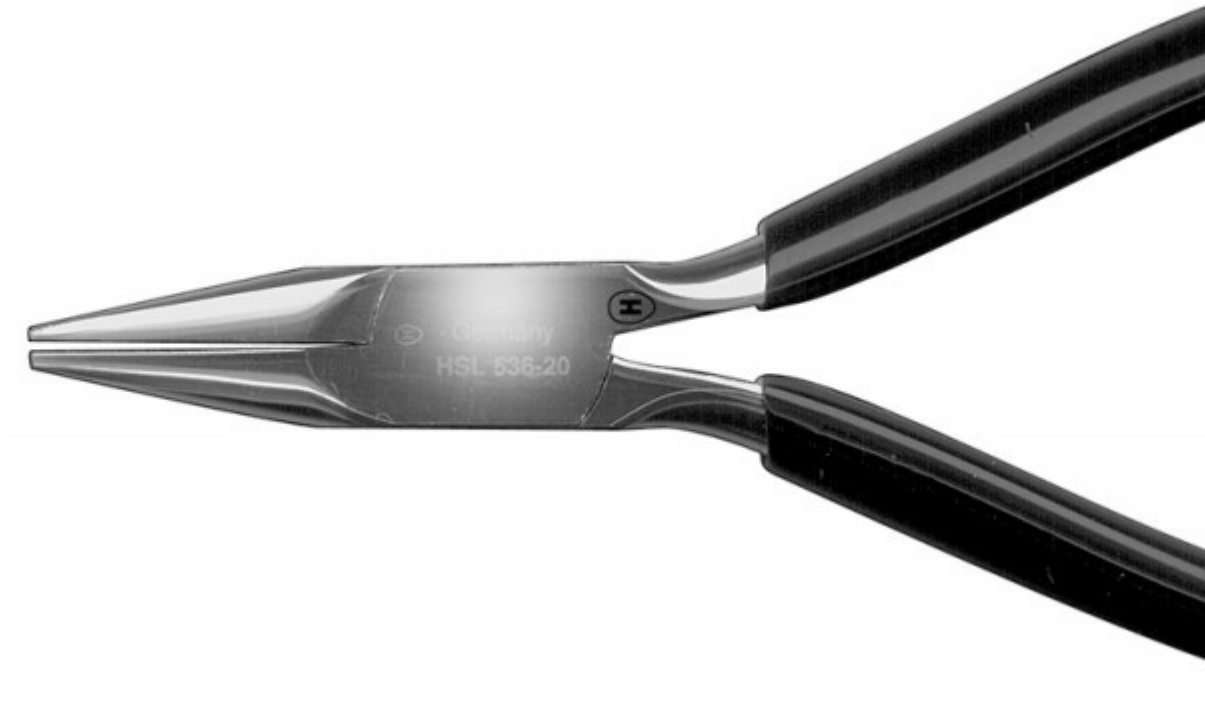

135 mm, with black plastic coated handles

HSL 536-10, Side Nipper

Category: Pliers

Order number: HSL_536-10

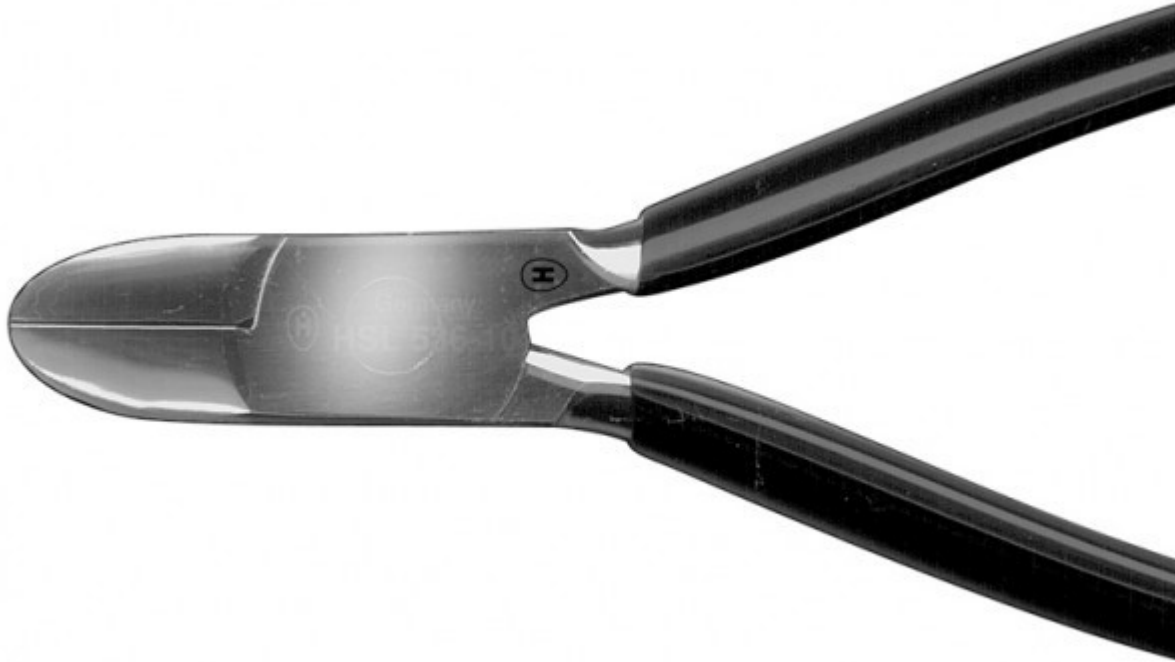

140 mm, with black plastic coated handles

HSL 519-18, Heavy-duty lever cutting nipper

Category: Pliers

Order number: HSL_519-18



Fantastico, 180 mm For hard wire until max. 1,5 mm/.059" diameter

HSL 506-18, Double action end nipper

Category: Pliers

Order number: HSL_506-18



180 mm

HSL 504-16, Double action side nipper

Category: Pliers

Order number: HSL_504-16



disinfectable 165 mm / 6-1/2 inch For hard wire until max. 1,2 mm / .047" Diameter

HSL 497-14, Side Nippers

Category: Pliers

Order number: HSL_497-14



disinfectable 140 mm / 5-1/2 inch chromium plated For hard wire until max. 1,2 mm / .047" diameter

HSL 494-12, Flat nose pliers

Category: Pliers

Order number: HSL_494-12

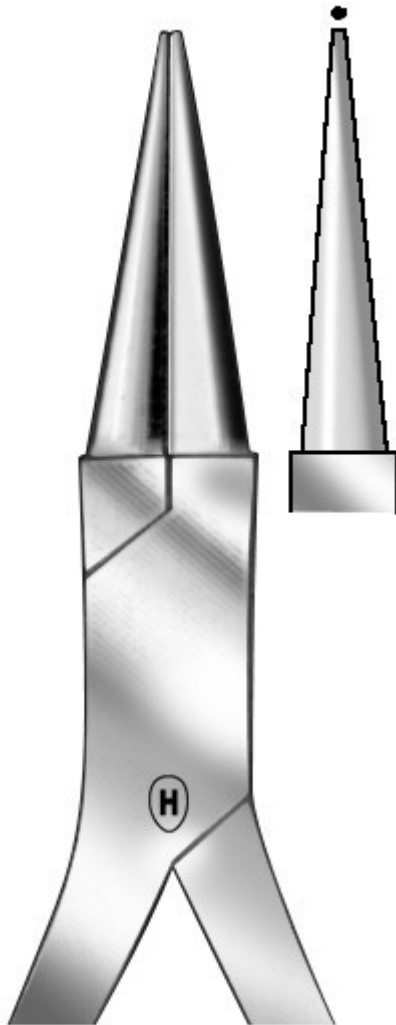

120 mm, chromium plated, smooth

HSL 493-12, Flat nose pliers

Category: Pliers

Order number: HSL_493-12

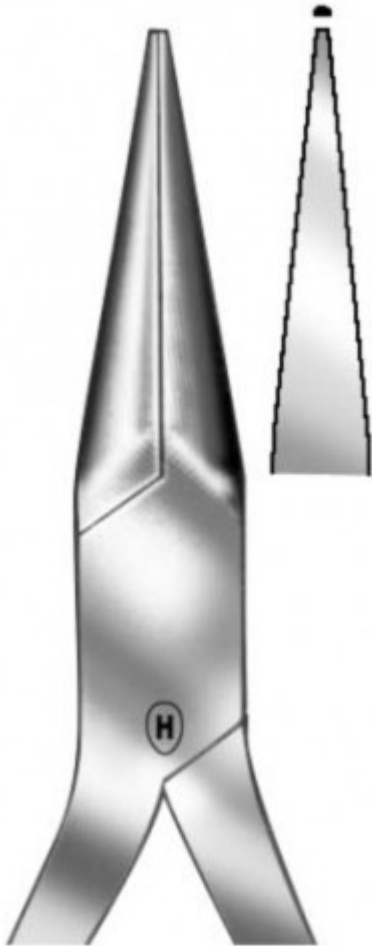

120 mm, chromium plated, serrated

HSL 491-12, Flat nose pliers

Category: Pliers

Order number: HSL_491-12

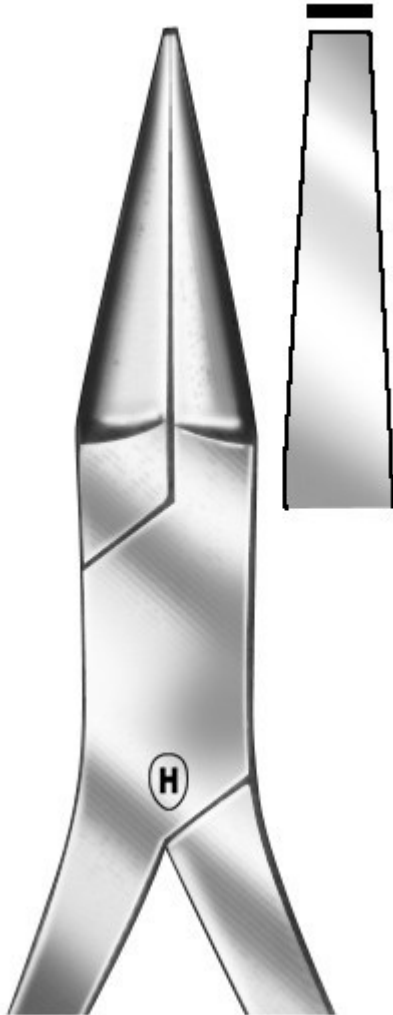

120 mm, chromium plated, serrated

HSL 490-12, Flat nose pliers

Category: Pliers

Order number: HSL_490-12



120 mm, chromium plated, smooth

HSL 483-13, Flat nose pliers

Category: Pliers

Order number: HSL_483-13

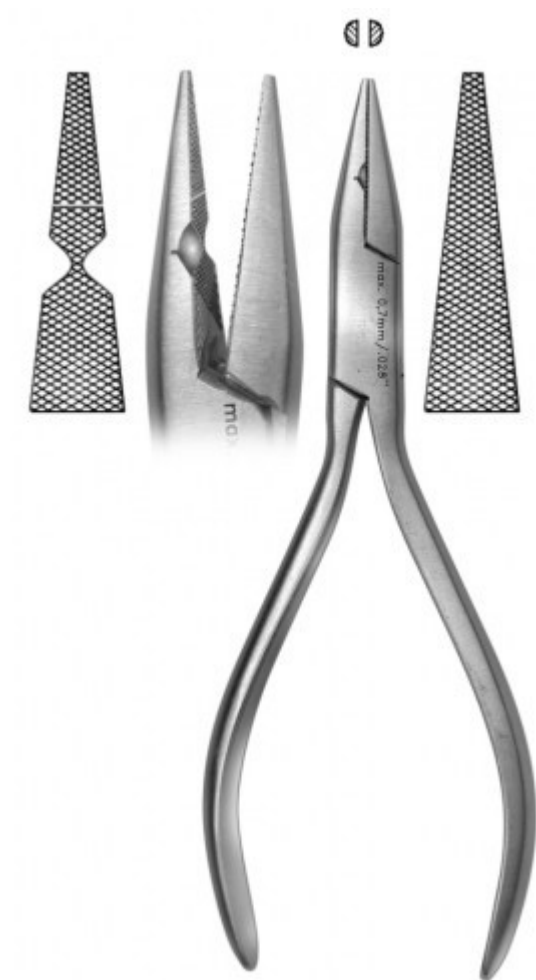

sterilizable with guide notch, serrated 130 mm / 5-1/8 inch For hard wire until max. 0,7 mm / .028" max.

HSL 477-14, Flat nose pliers

Category: Pliers

Order number: HSL_477-14



Marburg, 135 mm, serrated, until 0,7 mm / .028" diameter

HSL 474-13, Flat nose pliers

Category: Pliers

Order number: HSL_474-13



130 mm, serrated

HSL 472-14, Flat nose pliers

Category: Pliers

Order number: HSL_472-14

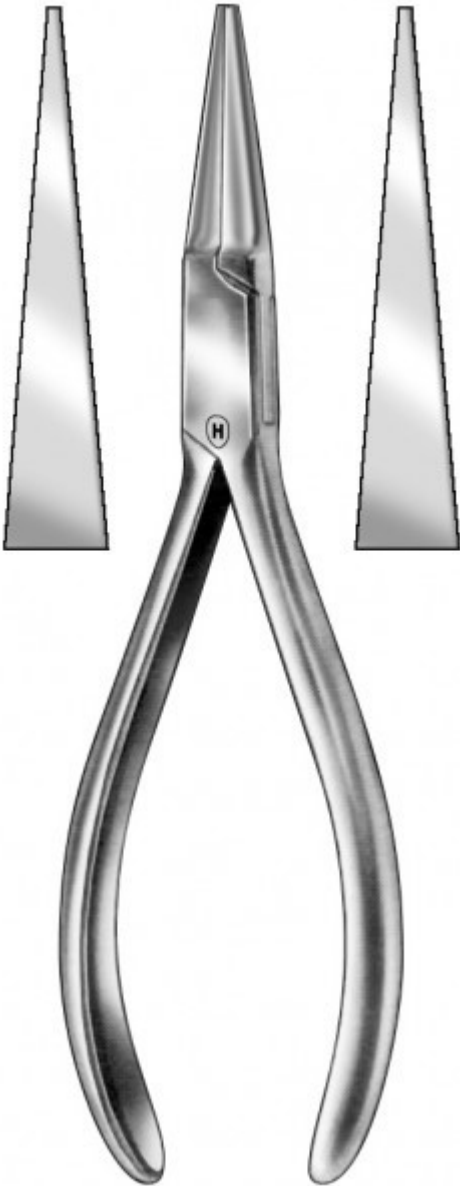

Langbeck, 140 mm, smooth

HSL 457-13, Contouring pliers

Category: Pliers

Order number: HSL_457-13

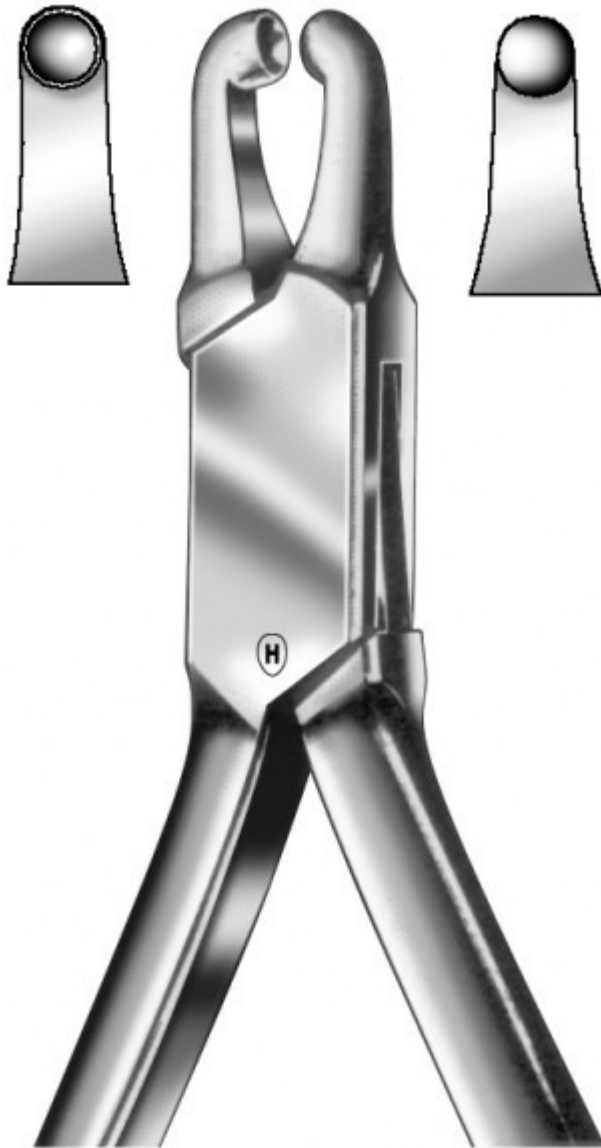

Abell, no. 112, 135 mm

HSL 455-13, Contouring pliers

Category: Pliers

Order number: HSL_455-13

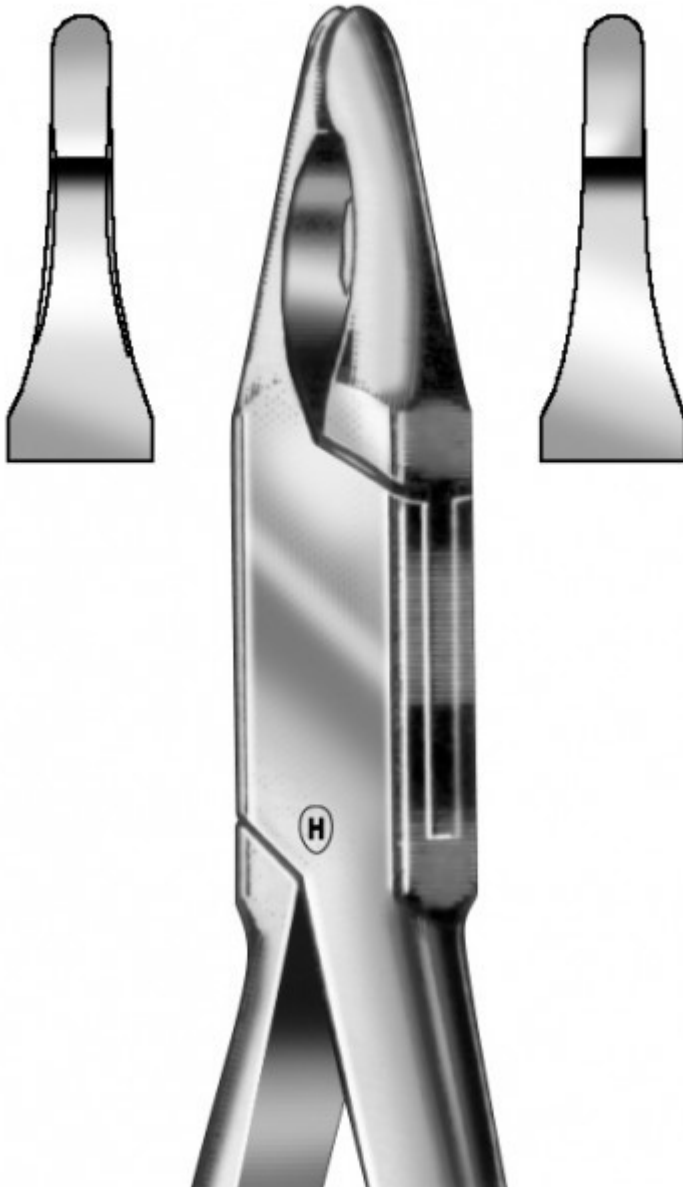

Johnson, No. 114, 130 mm

HSL 454-13, Contouring pliers

Category: Pliers

Order number: HSL_454-13

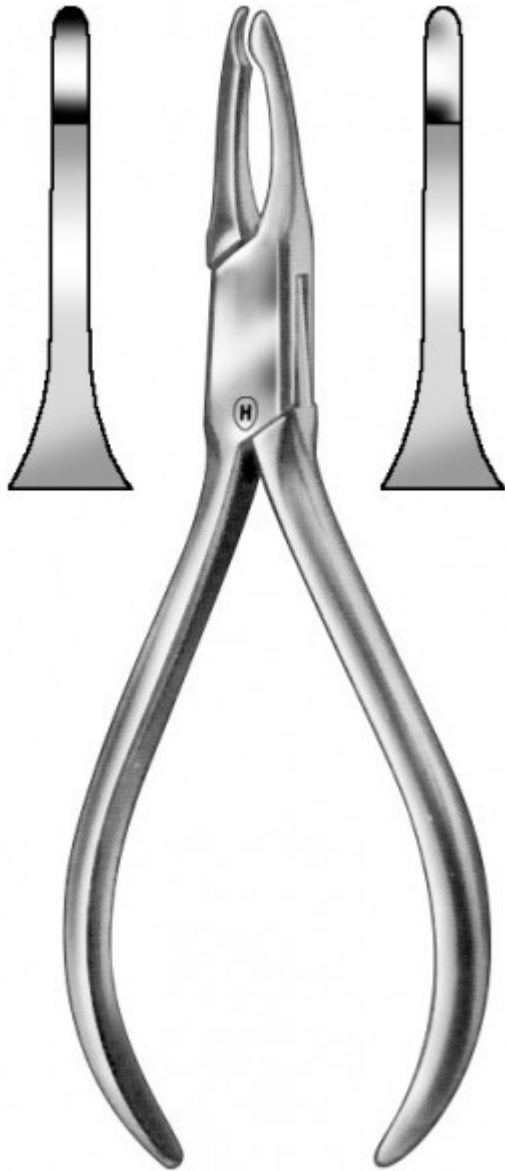

Johnson, No. 114 N, 130 mm

HSL 453-12, Contouring pliers

Category: Pliers

Order number: HSL_453-12



Reynolds, no. 115, 125 mm

HSL 451-13, Contouring pliers

Category: Pliers

Order number: HSL_451-13

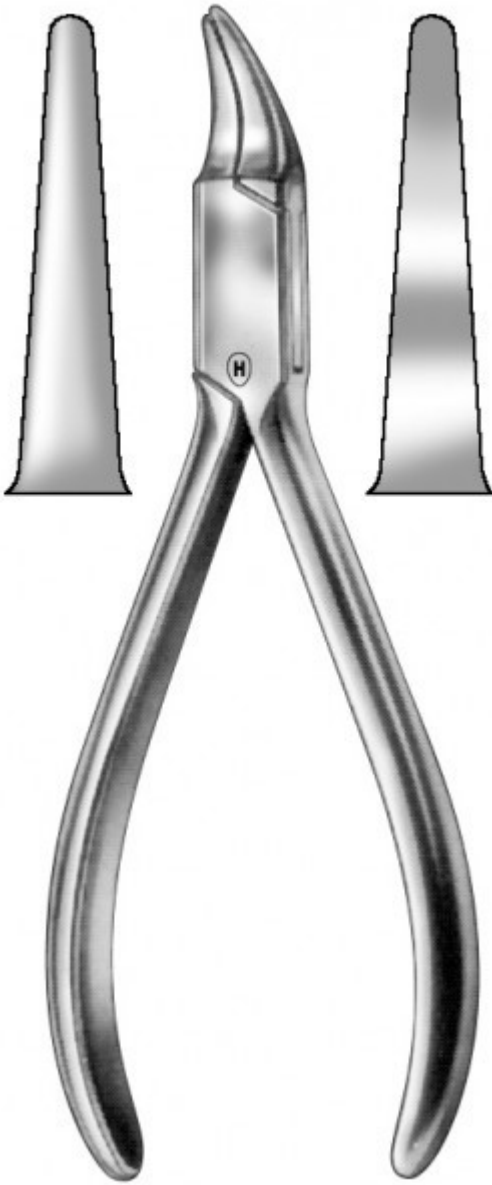

Gordon, no. 137, 130 mm

HSL 449-13, Contouring pliers

Category: Pliers

Order number: HSL_449-13



Goslee, no. 136, 130 mm

HSL 445-13, Arch forming pliers

Category: Pliers

Order number: HSL_445-13



Angle, sterilizable 120 mm / 4-3/4 inch For hard wire up to 0,7 mm /.028"

HSL 439-17, Pin bending pliers

Category: Pliers

Order number: HSL_439-17



170 mm, chromium plated

HSL 437-17, Pin bending pliers

Category: Pliers

Order number: HSL_437-17



170 mm, chromium plated

HSL 436-15, Universal pin bending pliers

Category: Pliers

Order number: HSL_436-15



sterilizable 155 mm / 6-1/8 inch with very delicate working ends Bends: hard wire up to 0,9 mm / .035" diameter max. Cuts: hard wire up to 0,7 mm / .028" diameter max.

HSL 433-15, Universal pin bending pliers

Category: Pliers

Order number: HSL_433-15



sterilizable 155 mm / 6-1/8 inch Bends: hard wire up to 0,9 mm / .035" diameter max. Cuts: hard wire up to 0,7 mm / .028" diameter max.

HSL 430-16, Bar bending pliers

Category: Pliers

Order number: HSL_430-16



Mc Kellops, no. 134, 160 mm, chromium plated

HSL 429-16, Bar bending pliers

Category: Pliers

Order number: HSL_429-16



Mc Kellops, no. 134, 160 mm

HSL 428-21, Clasp and wire bending pliers

Category: Pliers

Order number: HSL_428-21



Malotky, sterilizable 205 mm / 8 inch Suitable for face bows For hard profiled wire unitl max. 3,0 x 1,5 mm / .059"

HSL 42601-13, Wire and clasp bending pliers

Category: Pliers

Order number: HSL_42601-13



Aderer mini, 125 mm, GRIFFI

HSL 4260-12, Wire and clasp bending pliers

Category: Pliers

Order number: HSL_4260-12



Aderer mini, 125 mm

HSL 426-14, Wire and bar bending pliers

Category: Pliers

Order number: HSL_426-14



Aderer, sterilizable 140 mm / 5-1/2 inch For hard wire until max. 1,5 mm / .059" diameter

HSL 4233-13, Wire and clasp bending pliers

Category: Pliers

Order number: HSL_4233-13



Draht und Klammerbiegezange, 135 mm / 5-3/8 inch, sterilisierbar Kürzere und stärkere Arbeitsenden erlauben das Biegen vom äußeren Bogen des Head Gears und das Halten von stärkeren Drähten Für Rund- und Vierkantdrähte bis max. 1,8 mm / .072"

HSL 4232-13, Wire and clasp bending pliers

Category: Pliers

Order number: HSL_4232-13



Wire and clasp bending pliers, 130 mm / 5-1/4 inch, sterilizable For hard wire until max. 0,76 mm / .030" Durchmesser

HSL 4231-13, Wire and clasp bending pliers

Category: Pliers

Order number: HSL_4231-13



Wire and clasp bending pliers, 140mm / 5-5/8 inch, sterilizable For hard wire until max. 0,91 mm / .036" diameter

HSL 422-12, Wire and clasp bending pliers

Category: Pliers

Order number: HSL_422-12

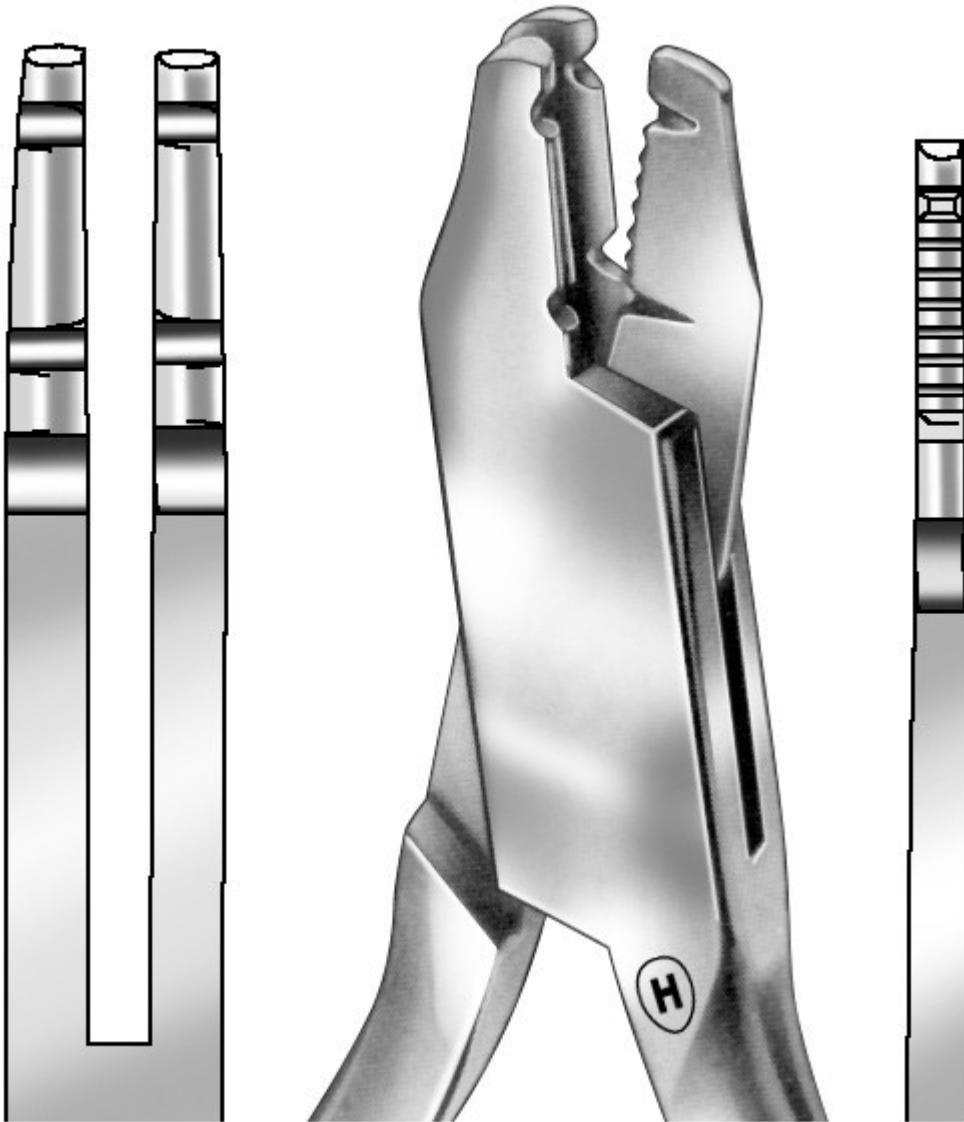

Aderer, 125 mm

HSL 419-11, Wire and clasp bending pliers

Category: Pliers

Order number: HSL_419-11



Aderer, sterilizable 115 mm / 4-1/2 inch For hard wire until max. 0,7 mm / .028" diameter

HSL 417-13, Closing loop pliers

Category: Pliers

Order number: HSL_417-13

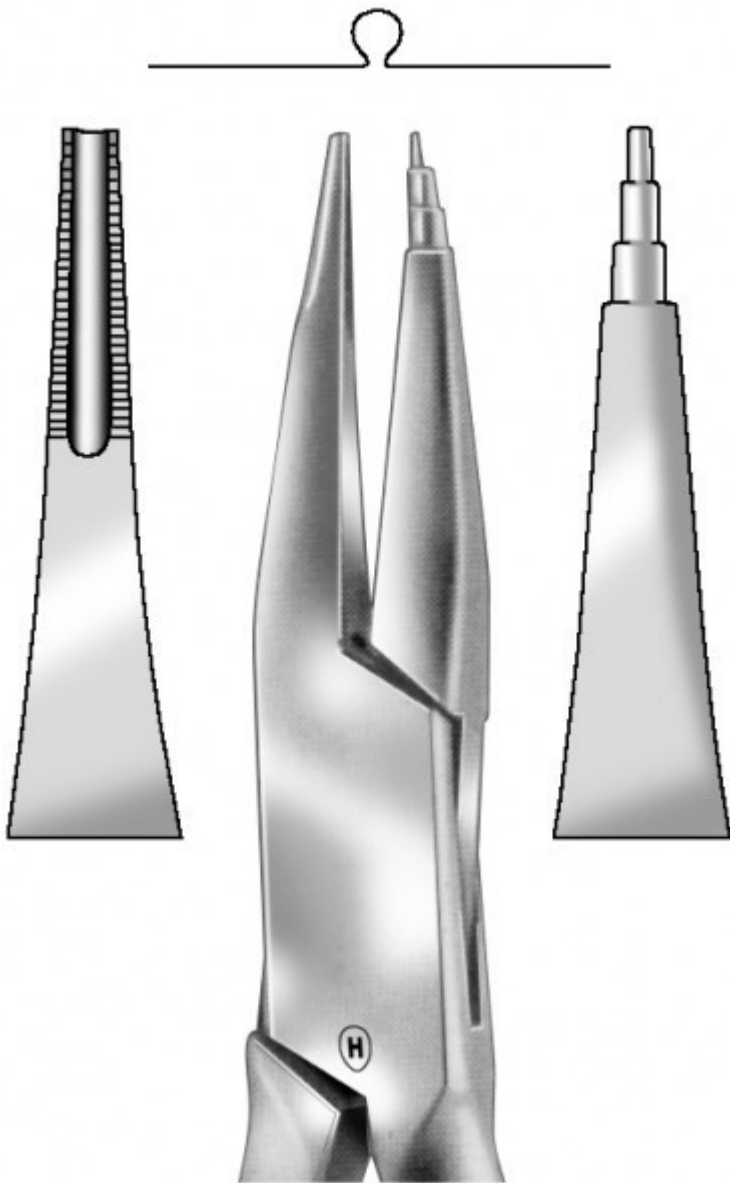

130 mm / 5-1/8 inch sterilizable For hard wire until max. 0,6 mm /.024" diameter

HSL 416-14, Closing loop pliers

Category: Pliers

Order number: HSL_416-14



140 mm

HSL 415-12, Closing loop pliers

Category: Pliers

Order number: HSL_415-12



Nance, sterilizable 130 mm / 5-1/8 inch For hard wire up to 0,7 mm /.028" diameter max.

HSL 411-11, Wire and clasp bending pliers

Category: Pliers

Order number: HSL_411-11



Aderer, very delicate, sterilizable 115 mm / 4-1/2 inch For wire of thicknesses 0,36 mm / .014" and 0,4 mm / .016" diameter Particularly recommended for all NiTi and thermal arches

HSL 408-13, Sling, clasp and wire bending pliers

Category: Pliers

Order number: HSL_408-13



130 mm

HSL 406-14, Sling, clasps and wire bending pliers

Category: Pliers

Order number: HSL_406-14



Adams modif., sterilizable With TC-inserts 125 mm / 4-7/8 inch For hard wire up to 0,7 mm / .028" diameter

HSL 404-15, Sling, clasps and wire bending pliers

Category: Pliers

Order number: HSL_404-13



Adams, sterilizable 130 mm / 5-1/8 inch For hard wire up to 0,7 mm / .028" diameter max.

HSL 403-12, Sling, clasps and wire bending pliers

Category: Pliers

Order number: HSL_403-12



Angle modif., sterilizable 125 mm / 4-7/8 inch For hard wire up to 0,7 mm / .028" diameter

HSL 401-13, Sling, clasp and wire bending pliers

Category: Pliers

Order number: HSL_401-13



Angel/Bird Beak, no. 139, sterilizable 130 mm / 5-1/8 inch For hard wire up to 0,7 mm /.028" diameter max.

HSL 399-15, Sling, clasp and wire bending pliers

Category: Pliers

Order number: HSL_399-15



130 mm

HSL 397-13, Sling, clasp and wire bending pliers

Category: Pliers

Order number: HSL_397-13



Ash no. 64, 130 mm

HSL 392-13, Round nose pliers

Category: Pliers

Order number: HSL_392-13



130 mm

HSL 390-13, Round nose pliers

Category: Pliers

Order number: HSL_390-13



130 mm

HSL 389-15, Wire and arch bending pliers

Category: Pliers

Order number: HSL_389-15



no. 101, Aderer

HSL 388-13, Wire and bar bending pliers

Category: Pliers

Order number: HSL_388-13



Jarabak, sterilizable 135 mm / 5-3/8 inch For hard wire until max. 0,5 mm / .020" diameter

HSL 386-13, Optical pliers

Category: Pliers

Order number: HSL_386-13



Schwarz, 135 mm for hard wire up to 0,7 mm /.028" diameter max.

HSL 382-13, Sling, clasp and wire bending pliers

Category: Pliers

Order number: HSL_382-13



Schwarz, 130 mm

HSL 380-13, Optical pliers

Category: Pliers

Order number: HSL_380-13



Schwarz, sterilizable 130 mm / 5-1/8 inch For hard wire up to 0,7 mm / .028" diameter max.

HSL 379-15, Sling, clasp and wire bending pliers

Category: Pliers

Order number: HSL_379-15



150 mm

HSL 377-13, Optical pliers

Category: Pliers

Order number: HSL_377-13



Schwarz, 135 mm, for hard wire up to 0,7 mm /.028" diameter max.

HSL 375-13, Orthodontic pliers

Category: Pliers

Order number: HSL_375-13



130 mm, Arrow clasp bending pliers For hard wire up to 0,7 mm / .028" diameter

HSL 374-12, Orthodontic pliers

Category: Pliers

Order number: HSL_374-12



Schwarz, 125 mm, arrow clasp forming pliers For hard wire up to 0,7 mm / .028" diameter

HSL 372-13, Loop bending pliers

Category: Pliers

Order number: HSL_372-13



Young, sterilizable 135 mm / 5-3/8 inch For hard wire up to 0,7 mm /.028" diameter max.

HSL 2423-12 Teleskopzange "Müllerbader"

Category: Pliers

Order number: HSL_2423-12

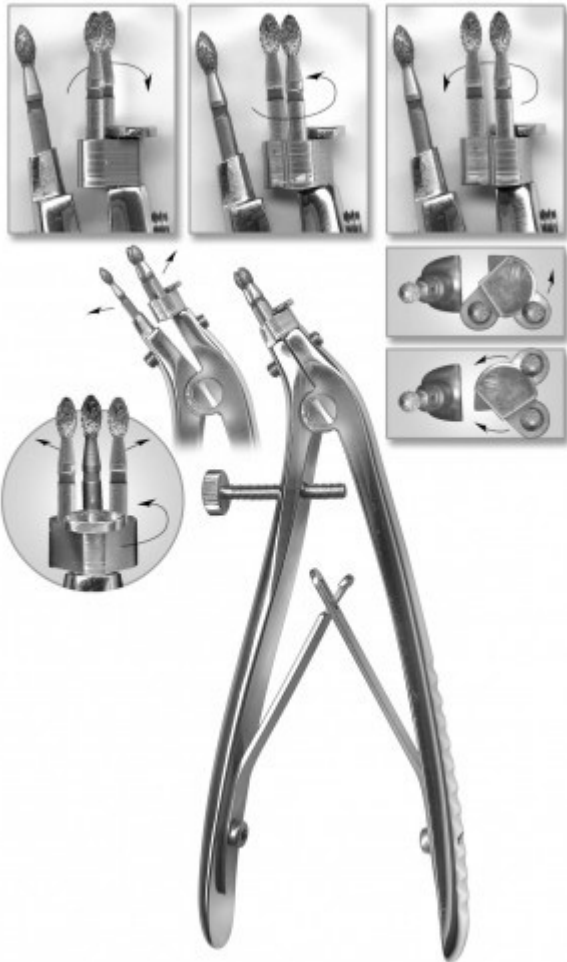

120 mm-die Greifspitzen liegen in der Ausgangspöosition fast auf einer Linie - für Seitenzähne - 3 Punktstützung- kein Abkippen der Kronen. besserer Halt - Verteilung des Drucks auf drei Auflagepunkte- die Greifspitzen bestehen aus auswechselbaren Diam

HSL 2422-12 Teleskopzange "Müllerbader"

Category: Pliers

Order number: HSL_2422-12

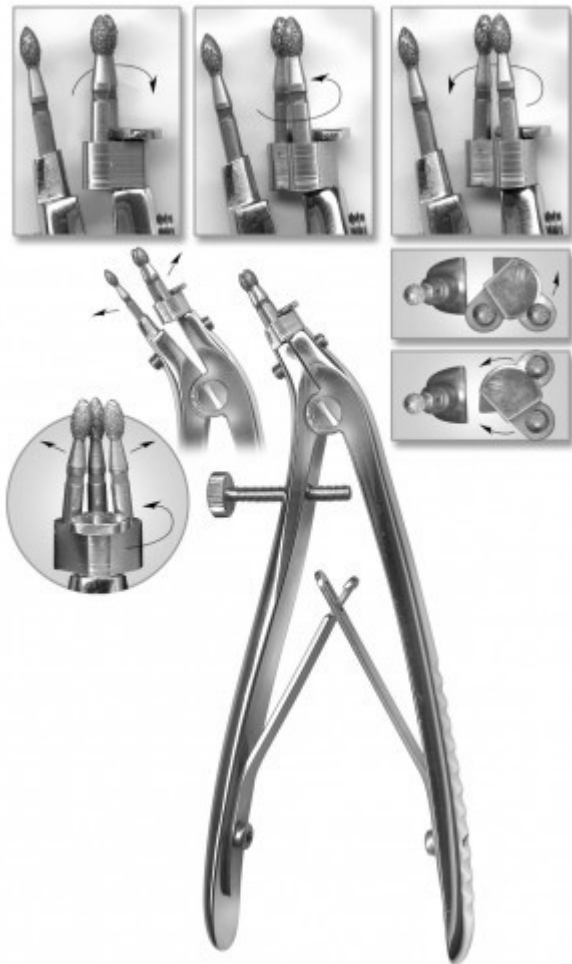

120 mm Die Teleskopzange hat drei auswechselbare Greifspitzen. Zwei der Greifspitzen sind beweglich an einem Halteabschnitt der Teleskopzange gelagert-während der andere Halteabschnitt nur eine Spitze hat. Beim Betätigen der Zange suchen sich die drei Greifs

HSL 236-12 Telescope crown pliers Teleflex Mini

Category: Pliers

Order number: HSL_236-12



Teleflex Mini according to Hoyer

По вопросам продаж и поддержки обращайтесь:

Алматы (727)345-47-04
Ангарск (3955)60-70-56
Архангельск (8182)63-90-72
Астрахань (8512)99-46-04
Барнаул (3852)73-04-60
Белгород (4722)40-23-64
Благовещенск (4162)22-76-07
Брянск (4832)59-03-52
Владивосток (423)249-28-31
Владикавказ (8672)28-90-48
Владимир (4922)49-43-18
Волгоград (844)278-03-48
Вологда (8172)26-41-59
Воронеж (473)204-51-73
Екатеринбург (343)384-55-89

Иваново (4932)77-34-06
Ижевск (3412)26-03-58
Иркутск (395)279-98-46
Казань (843)206-01-48
Калининград (4012)72-03-81
Калуга (4842)92-23-67
Кемерово (3842)65-04-62
Киров (8332)68-02-04
Коломна (4966)23-41-49
Кострома (4942)77-07-48
Краснодар (861)203-40-90
Красноярск (391)204-63-61
Курск (4712)77-13-04
Курган (3522)50-90-47
Липецк (4742)52-20-81

Магнитогорск (3519)55-03-13
Москва (495)268-04-70
Мурманск (8152)59-64-93
Набережные Челны (8552)20-53-41
Нижний Новгород (831)429-08-12
Новокузнецк (3843)20-46-81
Ноябрьск (3496)41-32-12
Новосибирск (383)227-86-73
Омск (3812)21-46-40
Орел (4862)44-53-42
Оренбург (3532)37-68-04
Пенза (8412)22-31-16
Петрозаводск (8142)55-98-37
Псков (8112)59-10-37
Пермь (342)205-81-47

Ростов-на-Дону (863)308-18-15
Рязань (4912)46-61-64
Самара (846)206-03-16
Санкт-Петербург (812)309-46-40
Саратов (845)249-38-78
Севастополь (8692)22-31-93
Саранск (8342)22-96-24
Симферополь (3652)67-13-56
Смоленск (4812)29-41-54
Сочи (862)225-72-31
Ставрополь (8652)20-65-13
Сургут (3462)77-98-35
Сыктывкар (8212)25-95-17
Тамбов (4752)50-40-97
Тверь (4822)63-31-35

Тольятти (8482)63-91-07
Томск (3822)98-41-53
Тула (4872)33-79-87
Тюмень (3452)66-21-18
Ульяновск (8422)24-23-59
Улан-Удэ (3012)59-97-51
Уфа (347)229-48-12
Хабаровск (4212)92-98-04
Чебоксары (8352)28-53-07
Челябинск (351)202-03-61
Череповец (8202)49-02-64
Чита (3022)38-34-83
Якутск (4112)23-90-97
Ярославль (4852)69-52-93

Россия +7(495)268-04-70

Казахстан +7(727)345-47-04

Беларусь +(375)257-127-884

Узбекистан +998(71)205-18-59

Киргизия +996(312)96-26-47

эл.почта: hqs@nt-rt.ru || сайт: <https://hammacher.nt-rt.ru/>