

Каталог продукции для стоматологических лабораторий Hammacher

По вопросам продаж и поддержки обращайтесь:

Алматы (727)345-47-04
Ангарск (3955)60-70-56
Архангельск (8182)63-90-72
Астрахань (8512)99-46-04
Барнаул (3852)73-04-60
Белгород (4722)40-23-64
Благовещенск (4162)22-76-07
Брянск (4832)59-03-52
Владивосток (423)249-28-31
Владикавказ (8672)28-90-48
Владимир (4922)49-43-18
Волгоград (844)278-03-48
Вологда (8172)26-41-59
Воронеж (473)204-51-73
Екатеринбург (343)384-55-89

Иваново (4932)77-34-06
Ижевск (3412)26-03-58
Иркутск (395)279-98-46
Казань (843)206-01-48
Калининград (4012)72-03-81
Калуга (4842)92-23-67
Кемерово (3842)65-04-62
Киров (8332)68-02-04
Коломна (4966)23-41-49
Кострома (4942)77-07-48
Краснодар (861)203-40-90
Красноярск (391)204-63-61
Курск (4712)77-13-04
Курган (3522)50-90-47
Липецк (4742)52-20-81

Магнитогорск (3519)55-03-13
Москва (495)268-04-70
Мурманск (8152)59-64-93
Набережные Челны (8552)20-53-41
Нижний Новгород (831)429-08-12
Новокузнецк (3843)20-46-81
Ноябрьск (3496)41-32-12
Новосибирск (383)227-86-73
Омск (3812)21-46-40
Орел (4862)44-53-42
Оренбург (3532)37-68-04
Пенза (8412)22-31-16
Петрозаводск (8142)55-98-37
Псков (8112)59-10-37
Пермь (342)205-81-47

Ростов-на-Дону (863)308-18-15
Рязань (4912)46-61-64
Самара (846)206-03-16
Санкт-Петербург (812)309-46-40
Саратов (845)249-38-78
Севастополь (8692)22-31-93
Саранск (8342)22-96-24
Симферополь (3652)67-13-56
Смоленск (4812)29-41-54
Сочи (862)225-72-31
Ставрополь (8652)20-65-13
Сургут (3462)77-98-35
Сыктывкар (8212)25-95-17
Тамбов (4752)50-40-97
Тверь (4822)63-31-35

Тольятти (8482)63-91-07
Томск (3822)98-41-53
Тула (4872)33-79-87
Тюмень (3452)66-21-18
Ульяновск (8422)24-23-59
Улан-Удэ (3012)59-97-51
Уфа (347)229-48-12
Хабаровск (4212)92-98-04
Чебоксары (8352)28-53-07
Челябинск (351)202-03-61
Череповец (8202)49-02-64
Чита (3022)38-34-83
Якутск (4112)23-90-97
Ярославль (4852)69-52-93

Россия +7(495)268-04-70

Казахстан +7(727)345-47-04

Беларусь +(375)257-127-884

Узбекистан +998(71)205-18-59

Киргизия +996(312)96-26-47

эл.почта: hds@nt-rt.ru || сайт: <https://hammacher.nt-rt.ru/>



STAINLESS STEEL



TITANIUM



WIRONIT

Instrumente aus rostfreiem Stahl sind rost sicher jedoch nicht rostfrei wie die Wironit Instrumente.

Instruments made of stainless steel are rust proof but not rust-free like the Wironit instruments.

Titan Instrumente sind 40 % leichter als Instrumente aus rostfreiem Stahl – sie sind absolut rost sicher und geeignet für alle gängigen Reinigungs- und Sterilisationsarten.

Titanium instruments are 40% lighter than instruments made of stainless steel - they are absolutely rust-proof and suitable for all common types of cleaning and sterilization.

Wironit

Wironit Instrumente sind aus einer Speziallegierung gefertigt und weisen folgende Vorteile auf:

- ✓ nichtrostend
- ✓ antimagnetisch
- ✓ säurebeständig

Sie sind formschön, liegen leicht in der Hand und sind von langer Lebensdauer.

Wironit instruments are made of a special alloy and show the following advantages:

- ✓ rust resistant
- ✓ anti-magnetic
- ✓ acid resistant

They are beautifully designed and of unlimited durability.

Alle mit CE gekennzeichneten Produkte sind Medizinprodukte.
Alle nicht mit CE gekennzeichneten Produkte sind keine Medizinprodukte.

All products marked with CE are medical devices.
All products not marked with CE are no medical devices.

Seiten / Pages

Kapitel / Chapter

Modellierinstrumente Modelling instruments	1	1
Kronen- und Blechscheren Plate shears, crown and collar scissors	10	2
Teleskopkronenzangen Telescope crown pliers	12	3
Messinstrumente Measuring instruments	17	4
Drahtschneide- und Biegezangen Wire cutting and bending pliers	19	5
Keramik-Instrumente Instruments for ceramics	34	6
Pinzetten Forceps	41	7
Allgemeine Werkzeuge und Hilfsmittel Universal tools and accessories	44	8
Solingen Classics	57	9



Katalog-Nr. Cat. No.	Abb. auf Seite Illustr. on page	Katalog-Nr. Cat. No.	Abb. auf Seite Illustr. on page	Katalog-Nr. Cat. No.	Abb. auf Seite Illustr. on page	Katalog-Nr. Cat. No.	Abb. auf Seite Illustr. on page
HSA		HSC 530-30	43	HSL 066-00	7	HSL 397-13	25
HSA 590-00	66	HSC 818-11	42	HSL 071-07	8	HSL 399-15	25
HSB		HSE		HSL 108-13	9	HSL 401-13	26
HSB 018-11	39	HSE 010-09	37	HSL 109-17	9	HSL 403-12	26
HSB 391-10	65	HSE 011-09	37	HSL 110-00	9	HSL 404-13	26
HSB 582-12	56	HSE 016-12	37	HSL 112-13	9	HSL 406-14	26
HSB 586-18	56	HSE 017-12	37	HSL 115-17	9	HSL 411-11	27
HSB 588-20	56	HSE 022-12	37	HSL 118-13	9	HSL 413-11	27
HSB 596-20	56	HSE 023-12	37	HSL 119-17	9	HSL 415-12	25
HSB 598-18	56	HSG		HSL 121-18	49	HSL 417-13	25
HSB 602-14	56	HSG 051-00	7	HSL 122-16	49	HSL 419-11	27
HSB 624-16	56	HSH		HSL 123-16	49	HSL 420-12	27
HSB 630-10	10	HSH 031-12	8	HSL 123-18	49	HSL 422-12	28
HSB 636-25	56	HSH 035-61	8	HSL 129-13	50	HSL 423-1-13	28
HSB 638-09	10	HSH 048-03	8	HSL 147-00	34	HSL 423-12	28
HSB 652-09	65	HSH 096-00	5	HSL 219-16	15	HSL 426-14	29
HSB 653-10	10	HSH 097-00	5	HSL 233-12	12	HSL 428-21	29
HSB 659-12	10	HSH 098-00	5	HSL 234-12	12	HSL 429-16	29
HSB 661-12	10	HSH 101-00	5	HSL 235-15	12	HSL 431-15	30
HSB 662-09	10	HSH 102-00	5	HSL 236-12	14	HSL 433-15	30
HSB 663-09	10	HSH 106-00	5	HSL 237-12	13	HSL 436-15	30
HSB 664-11	11	HSH 563-00	39	HSL 237-12	13	HSL 444-12	31
HSB 665-11	11	HSL		HSL 237-12	14	HSL 445-13	31
HSB 704-10	54	HSL 023-15	1	HSL 238-15	13	HSL 446-12	31
HSB 705-11	54	HSL 024-01	1	HSL 239-17	15	HSL 454-13	31
HSB 707-15	54	HSL 025-02	1	HSL 242-06	39	HSL 470-14	32
HSB 742-00	54	HSL 026-03	1	HSL 2421-12	14	HSL 477-14	32
HSB 743-00	54	HSL 027-04	1	HSL 2422-12	16	HSL 478-13	32
HSB 746-00	54	HSL 028-05	1	HSL 2424-99	16	HSL 479-13	32
HSB 747-01	54	HSL 029-00	6	HSL 245-00	17	HSL 481-12	33
HSB 748-02	54	HSL 030-00	6	HSL 245-12	17	HSL 483-13	33
HSB 750-00	54	HSL 031-00	6	HSL 246-00	17	HSL 487-14	32
HSB 751-01	54	HSL 032-00	6	HSL 246-15	18	HSL 491-12	33
HSB 752-02	54	HSL 033-00	6	HSL 246-15	18	HSL 491-12	33
HSB 756-06	54	HSL 035-01	6	HSL 247-00	17	HSL 493-12	33
HSB 800-12	39	HSL 036-07	6	HSL 247-10	17	HSL 494-12	33
HSB 805-03	54	HSL 043-01	6	HSL 247-20	17	HSL 497-14	19
HSC		HSL 044-02	6	HSL 250-00	18	HSL 504-16	19
HSC 011-04	36	HSL 045-03	6	HSL 252-15	18	HSL 510-17	11
HSC 058-18	43	HSL 049-01	7	HSL 252-20	18	HSL 512-17	11
HSC 060-20	43	HSL 049-02	7	HSL 278-11	19	HSL 516-14	11
HSC 062-25	43	HSL 050-12	7	HSL 280-12	19	HSL 519-18	19
HSC 064-30	43	HSL 051-17	7	HSL 359-13	21	HSL 520-06	35
HSC 510-16	36	HSL 052-17	7	HSL 362-12	21	HSL 521-71	35
HSC 511-16	36	HSL 053-00	7	HSL 364-13	24	HSL 522-00	35
HSC 517-17	36	HSL 054-00	7	HSL 368-13	20	HSL 522-01	35
HSC 518-14	40	HSL 055-00	7	HSL 369-13	21	HSL 522-02	35
HSC 518-99	40	HSL 058-01	8	HSL 374-12	20	HSL 522-03	35
HSC 519-17	36	HSL 059-02	8	HSL 375-13	20	HSL 522-04	35
HSC 524-16	42	HSL 060-03	8	HSL 377-13	23	HSL 522-05	35
HSC 525-30	42	HSL 062-07	8	HSL 379-15	23	HSL 522-06	35
HSC 528-16	43			HSL 380-13	23	HSL 522-07	35
HSC 529-16	43			HSL 382-13	23	HSL 522-08	35
				HSL 386-13	24	HSL 536-00	22
				HSL 3881-14	24	HSL 536-01	22
				HSL 388-13	24	HSL 536-10	22

Katalog-Nr. Cat. No.	Abb. auf Seite Illustr. on page	Katalog-Nr. Cat. No.	Abb. auf Seite Illustr. on page	Katalog-Nr. Cat. No.	Abb. auf Seite Illustr. on page	Katalog-Nr. Cat. No.	Abb. auf Seite Illustr. on page
HSL 536-20	22	HSL 750-00	5	HWB		HWN 337-35	45
HSL 536-30	22	HSL 751-00	5	HWB 202-20	39	HWN 338-55	45
HSL 536-40	22			HWC		SGCI	
HSL 536-50	22	HSM		HWC 016-04	36	SGCI 050-00	57
HSL 548-16	41	HSM 139-12	65			SGCI 051-20	57
HSL 549-16	41	HSM 140-13	65	HWH		SGCI 052-15	57
HSL 550-99	41	HSM 145-01	65	HWH 217-00	4	SGCI 100-09	58
HSL 551-00	34	HSM 150-00	64	HWH 218-00	4	SGCI 101-09	58
HSL 552-01	34	HSM 150-06	64	HWH 220-00	4	SGCI 102-13	58
HSL 553-02	34			HWH 221-00	4	SGCI 103-15	58
HSL 554-03	34	HSN		HWH 225-00	4	SGCI 104-20	58
HSL 555-04	34	HSN 200-08	52	HWH 226-00	4	SGCI 105-23	58
HSL 556-05	34	HSN 201-10	52	HWH 227-00	4	SGCI 106-15	58
HSL 557-06	34	HSN 202-13	52	HWH 228-00	4	SGCI 107-20	58
HSL 558-07	34	HSN 203-16	52			SGCI 108-00	60
HSL 559-08	34	HSN 204-18	52	HWL		SGCI 109-00	58
HSL 560-10	34	HSN 205-21	52	HWL 030-00	2	SGCI 110-12	59
HSL 562-06	34	HSN 210-07	52	HWL 031-01	3	SGCI 111-14	59
HSL 563-00	35	HSN 211-10	52	HWL 032-02	3	SGCI 112-31	59
HSL 566-00	39	HSN 212-13	52	HWL 033-03	3	SGCI 113-15	59
HSL 572-00	38	HSN 213-15	52	HWL 034-06	3	SGCI 114-18	59
HSL 573-00	38	HSN 214-20	52	HWL 035-00	3	SGCI 115-00	59
HSL 574-00	38	HSN 215-25	52	HWL 036-00	3	SGCI 116-06	60
HSL 576-00	38	HSN 216-30	52	HWL 037-00	3	SGCI 117-10	60
HSL 577-00	38	HSN 218-13	53	HWL 038-03	3	SGCI 118-18	60
HSL 603-00	34	HSN 220-08	52	HWL 039-07	3	SGCI 119-13	60
HSL 604-01	34	HSN 221-10	52	HWL 100-13	9	SGCI 130-09	61
HSL 605-02	34	HSN 222-13	52	HWL 101-17	9	SGCI 131-13	61
HSL 606-03	34	HSN 225-08	53	HWL 102-14	48	SGCI 132-14	61
HSL 607-04	34	HSN 226-10	53	HWL 103-14	48	SGCI 133-13	61
HSL 608-05	34	HSN 227-13	53	HWL 106-17	48	SGCI 134-13	61
HSL 609-06	34	HSN 230-08	53	HWL 107-17	48	SGCI 135-15	61
HSL 610-07	34	HSN 231-10	53	HWL 108-06	48	SGCI 136-18	61
HSL 611-08	34	HSN 232-13	53	HWL 109-07	48	SGCI 137-31	61
HSL 612-10	34	HSN 235-08	53	HWL 390-00	66	SGCI 138-15	62
HSL 650-19	47	HSN 236-10	53			SGCI 139-18	62
HSL 651-00	47	HSN 237-13	53	HWN		SGCI 140-23	62
HSL 653-00	47	HSN 290-19	51	HWN 250-18	50	SGCI 141-15	62
HSL 654-19	47	HSN 291-17	51	HWN 251-20	50	SGCI 142-20	62
HSL 655-00	47	HSN 292-19	51	HWN 252-22	50	SGCI 143-15	62
HSL 660-21	55	HSN 308-00	46	HWN 260-15	50	SGCI 144-26	62
HSL 668-20	55	HSN 308-99	46	HWN 261-15	50	SGCI 330-07	63
HSL 669-18	55	HSN 311-01	46	HWN 265-15	50	SGCI 335-03	63
HSL 670-12	55	HSN 312-02	46	HWN 270-21	50	SGCI 338-00	63
HSL 671-25	55	HSN 330-22	44	HWN 271-21	50	SGCI 340-05	63
HSL 672-25	55	HSN 331-25	44	HWN 272-22	51		
HSL 673-12	55	HSN 332-30	44	HWN 273-21	51		
HSL 676-00	55	HSN 333-40	44	HWN 300-22	44		
HSL 678-00	55	HSN 334-50	44	HWN 301-25	44		
HSL 679-01	55	HSN 335-60	44	HWN 302-32	44		
HSL 680-02	55	HSN 338-55	44	HWN 309-25	45		
HSL 681-03	55			HWN 310-20	44		
HSL 684-01	55	HTC		HWN 312-28	44		
HSL 685-02	55	HTC 090-11	42	HWN 313-19	45		
HSL 686-03	55						



Achatspatel	5	Hartgipsschneidezangen	47
Adams Draht- und Bogenbiegezange	26	Hebelseitenschneider	19
Adams mod. Draht- und Bogenbiegezange	26	Hollenback Modellierinstrumente	8
Adams mod. Drahtbiegezange	21	Hünebeck Universalhaltezeuge	45
Aderer Draht- und Klammerbiegezange	27 - 29	Hylin Modellierinstrumente	7
Angle / Bird Beak Draht- und Bogenbiegezange	26	Hylin-Le Cron Modellierinstrumente	7
Angle / Tweed Bogenformzange	31	Instrumente, Aufwachs-	1
Angle Bogenbiegezange	31	Instrumente, K&B-	7
Angle mod. Draht- und Bogenbiegezange	26	Instrumente, Keramik-	36 - 40
Antkoviak Wachsmesser	9	Instrumente, Keramik-Modellier-	38
Apothekerspatel	53	Instrumente, Modellier-	1 - 9
Ash Draht- und Bogenbiegezange	25	Interlook-Hammacher Messzirkel	17
Aufwachsinstrumente	1	Iwanson Messzirkel	17
Aufwachspinsel	34	Jarabak Draht- und Bügelbiegezange	24
Beale Modellierinstrumente	8	Jarinda Draht- und Bügelbiegezange	24
Becher, Gips-	50	Johnson Konturenzange	31
Blechscheren	11	K&B-Instrumente	7
Böhm Teleskopkronenzange	12	Keramikinstrumente	36 - 40
Börtelzangen	31	Keramik-Modellierinstrumente	38
Boley Schieblehren	17	Keramikpinsel	34, 35
Brenner	46	Klemmen	37, 39, 40
Brennguträgerpinzetten	43	Klemmen, Spezial-Halte-	40
Buffalo-Hammacher Gipsmesser	48	Klingen, Skalpell-	54
Drahtbiegezangen	20 - 30	Konturenzangen	31
Drahtschneidezangen	19, 22	Kramponzangen	30
ERGRO-BRUSH Pinselhalter	35	Kronenhaltepinzetten	36
Fahnenstock Wachsmesser	9	Kronenscheren	10, 11
Fantastico Hebelseitenschneider	19	Küvettenzangen	44
Feilen, Separier-	39	Laborscheren	56
Flachzangen	32, 33	Langbeck Flachzange	32
Folienmesser	54	Laubsägeblätter	55
Folienscheren	10, 39	Laubsägebögen	55
Frahm Modellierinstrumente	8	Le Cron Modellierinstrumente	7
Geppert Pinzetten	42	Lehren, Schieb-	17, 18
Gipsbecher	50	Lessmann Wachsmesser	9
Gipsmesser	48, 49	Loop-Biegezangen	25
Glasplatten	5	Lötpinzetten	36, 43
Glasspatel	39	Malotky Draht- und Bügelbiegezange	29
Griffe, Skalpell-	54	Marburg Flachzange	32
Gritman Gipsmesser	48, 49	MasterLine Modellierinstrumente	2, 3
Halsted-Mosquito Klemme	37	McKelops Bügelbiegezange	29
Halteklemmen, Spezial-	40	Messer, Folien-	54
Halter, Pinsel-	35	Messer, Gips-	48, 49
Haltezangen, Universal-	44, 45	Messer, Modellier-	39
Hammacher Farbinstrumente	6	Messer, Spatel-	52, 53
Hammacher Gipsmesser	49	Messer, Wachs-	9
Hammacher Hartgipsschneidezange	47	Messzirkel	17
Hammacher Kronenhaltepinzetten	36	Micro-Halsted Klemme	37
Hammacher Teleskopaktivierungszange	15	Micro-Hartmann Klemme	37
Hammacher Teleskopkronenzange	12, 14	Mini-Le Cron Modellierinstrumente	7
Hammacher-Aderer Draht- und Klammerbiegezange	27	Misch- und Laborspatel	50 - 53
Hammacher-Hoyer Modellierinstrumente	2, 3	Mitchell Modellierinstrumente	7
Hammer, Niet-	55	Modellierinstrumente	1 - 9



Modellierinstrumente, Keramik-	38	Skalpellschlingen	54
Modelliermesser	39	Smart Clip Spezial-Halteklammer	40
Modellsägen	55	Solingen Classics	57 - 66
Muffelzangen	45	Spatel, Achat-	5
Müllerbader Teleskopzange	16	Spatel, Apotheker-	53
Nance Schlaufenbiegegeze	25	Spatel, Glas-	39
Niethammer	55	Spatel, Misch- und Labor-	50 - 53
P.K. Thomas Aufwachsinstrumente	1	Spatel, Separier-	4
Papierscheren	56	Spatel-Messer	52, 53
Pfeilformzange	20	Spezial Kronenscheren	10
Pfeilknickzange	20	Spezial-Halteklammer	40
Pinsel, Aufwachs-	34	Ständer, Pinsel-	35
Pinsel, Keramik-	34, 35	Taschenscheren	56
Pinsel, Rotmarder-	34	Teleflex Grazil Teleskopkronenzange	14
Pinsel, Rotmarder-Kolinsky-	34	Teleflex Mini Teleskopkronenzange	13, 14
Pinsel, Wachs-	34	Teleflex Teleskopkronenzange	13
Pinselhalter	35	Teleskopaktivierungszange	15
Pinselköpfe	35	Teleskopkronenzangen	12 - 16
Pinselständer	35	Teleskopzangen	16
Pinzetten	36, 41 - 43	Tiefziehscheren	10
Pinzetten für Zirkonarbeiten	41	Tiegelzangen	44
Pinzetten, Brenngutträger-	43	Uhrmacherpinzetten	42
Pinzetten, Kronenhalte-	36	Universal Kronenscheren	10
Pinzetten, Löt-	36, 43	Universalhalte-zangen	44, 45
Pinzetten, Präparier-	42	Universalzangen	30
Pinzetten, Uhrmacher-	42	Verbandscheren	56
Platte, Glas-	5	Wachsmesser	9
Präparierpinzetten	42	Wachspinsel	34
Quattuor Teleskopkronenzange	15	Waldsachs Universalzange	30
Rotmarder-Kolinsky-Pinsel	34	Wiessner Rührstab	7
Rotmarder-Pinsel	34	Wipphahn-Brenner	46
Rührstab	7	Zahle Modellierinstrumente	8
Rundzangen	33	Zangen, Börtel-	31
Sägen-, Modell-	55	Zangen, Drahtbiege-	20 - 30
Scheren, Blech-	11	Zangen, Drahtschneide-	19, 22
Scheren, Folien-	10, 39	Zangen, Flach-	32, 33
Scheren, Kronen-	10, 11	Zangen, Hartgipsschneide-	47
Scheren, Labor-	56	Zangen, Konturen-	31
Scheren, Papier-	56	Zangen, Krampon-	30
Scheren, Taschen-	56	Zangen, Küvetten-	44
Scheren, Tiefzieh-	10	Zangen, Muffel-	45
Scheren, Verband-	56	Zangen, Rund-	33
Schieblehren	17, 18	Zangen, Teleskop-	16
Schneidezangen, Draht-	19	Zangen, Teleskopaktivierungs-	15
Schulz-Hammacher Teleskopkronenzange	15	Zangen, Teleskopkronen-	12 - 16
Schwarz Draht- und Bügelbiegegeze	23, 24	Zangen, Tiegel-	44
Schwarz Pfeilformzange	20	Zangen, Universal-	30
Schwarz Pfeilknickzange	20	Zangen, Universalhalte-	44, 45
Seitenschneider	19	Zentel-Maß-Uhr	18
Seitenschneider, Hebel-	19	Zirkel, Mess-	17
Separierfeilen	39	Zirkon-Pinzetten	41
Separierspatel	4		
Skalpellschlingen	54		



Adams mod. Sling, claps and wire bending pliers	26	Fantastico Double action side nippers	19
Adams mod. Wire bending pliers	21	Files, Separating	39
Adams Sling, claps and wire bending pliers	26	Flat nose pliers	32, 33
Aderer Wire and clasp bending pliers	27 - 29	Foil knives	54
Agate spatulas	5	Forceps	37, 39, 40
Angle / Bird Beak Sling, claps and wire bending pliers	26	Forceps for watch-makers	42
Angle / Tweed Tweed arch forming pliers	31	Forceps for Zirconium works	41
Angle Arch forming pliers	31	Forceps, Crown holding	36
Angle mod. Sling, claps and wire bending pliers	26	Forceps, Dissecting	42
Antkoviak Wax knives	9	Frahm Modelling instruments	8
Arrow clasp bending pliers	20	Frames for fret saws	55
Arrow clasp forming pliers	20	Fret saw blades	55
Ash Sling, clasp and wire bending pliers	25	Fret saw frames	55
Band crimping pliers	31	Fuel carrier pincers	43
Bandage scissors	56	Geppert Forceps	42
Beale Modelling instruments	8	Glass slabs	5
Blades for fret saws	55	Glass spatulas	39
Blades for scalpels	54	Gritman Plaster knives	48, 49
Böhm Telescope crown pliers	12	Halsted-Mosquito Forceps	37
Boley Sliding calipers	17	Hammacher Coloured instruments	6
Brush heads	35	Hammacher Crown holding forceps	36
Brush holders	35	Hammacher Hard plaster nippers	47
Brush stations	35	Hammacher Plaster knives	49
Brushes for ceramics	34, 35	Hammacher Telescope activating pliers	15
Brushes for wax	34	Hammacher Telescope crown pliers	12, 14
Brushes Rotmarder	34	Hammacher-Aderer Wire and clasp bending pliers	27
Brushes Rotmarder-Kolinsky	34	Hammacher-Hoyer Modelling instruments	2, 3
Buffalo-Hammacher Plaster knives	48	Hammer, Riveting	55
Bulb tongs	44	Handles for scalpels	54
Burners	46	Hard plaster nippers	47
Burners, Double-lever-stopcock	46	Holders for brushes	35
Calipers, Dial	18	Holding clips, Special	40
Calipers, Measuring	17	Hollenback Modelling instruments	8
Calipers, Sliding	17, 18	Hünebeck Universal holding tongs	45
Carvers, Modelling for ceramics	38	Hylin Modelling instruments	7
Ceramic brushes	34, 35	Hylin-Le Cron Modelling instruments	7
Ceramic instruments	36 - 40	Instruments for ceramics	36 - 40
Ceramic modelling carvers	38	Instruments, Crown and bridge	7
Chemist's spatulas	53	Instruments, Modelling	1 - 9
Clips, Holding Special	40	Instruments, Waxing	1
Closing loop pliers	25	Interlook-Hammacher Measuring calipers	17
Contouring pliers	31	Iwanson Measuring calipers	17
Crown and bridge instruments	7	Jarabak Wire and bar bending pliers	24
Crown and collar scissors	10, 11	Jarinda Wire and bar bending pliers	24
Crown holding forceps	36	Johnson Contouring pliers	31
Crucible tongs	44, 45	Knives, Foil	54
Cutting pliers	19	Knives, Modelling	39
Dial calipers	18	Knives, Plaster	48, 49
Dissecting forceps	42	Knives, Spatula	52, 53
Double action side nippers	19	Knives, Wax	9
Double-lever-stopcock burners	46	Laboratory scissors	56
ERGRO-BRUSH Brush holder	35	Langbeck Flat nose pliers	32
Fahnenstock Wax knives	9	Le Cron Modelling instruments	7



Lessmann Wax knives	9	Schwarz Arrow clasp forming pliers	20
Malotky Clasp and wire bending pliers	29	Schwarz Sling, clasp and wire bending	23, 24
Marburg Flat nose pliers	32	Scissors for crown and collar	10, 11
MasterLine Modelling instruments	2, 3	Scissors for foils and splints	10, 39
McKellops Bar bending pliers	29	Scissors, Bandage	56
Measuring calipers	17	Scissors, Laboratory	56
Micro-Halsted Forceps	37	Scissors, Paper	56
Micro-Hartmann Forceps	37	Scissors, Pocket	56
Mini-Le Cron Modelling instruments	7	Separating files	39
Mitchell Modelling instruments	7	Separating spatulas	4
Mixing bowl for plaster	50	Side nippers, Double action	19
Mixing spatulas for plaster and alginates	50 - 53	Slabs, Glass	5
Model saws	55	Sliding calipers	17, 18
Modelling carvers for ceramics	38	Smart Clip Special holding clip	40
Modelling instruments	1 - 9	Soldering tweezers	36, 43
Modelling knives	39	Solingen Classics	57 - 66
Müllerbader Telescope pliers	16	Spatula-knives	52, 53
Nance Closing loop pliers	25	Spatulas for chemists	53
Nippers, Double action side	19	Spatulas, Agate	5
Nippers, Hard plaster	47	Spatulas, Glass	39
P.K. Thomas Waxing instruments	1	Spatulas, Mixing for plaster and alginates	50 - 53
Paper scissors	56	Spatulas, Separating	4
Pin bending pliers	30	Special holding clip	40
Pincers, Fuel carrier	43	Spezial Crown and collar scissors	10
Plaster knives	48, 49	Station for brushes	35
Plaster mixing bowls	50	Stirring rod	7
Plate shears	11	Teleflex Brazil Telescope crown pliers	14
Pliers, Arrow clasp bending	20	Teleflex Mini Telescope crown pliers	13, 14
Pliers, Arrow clasp forming	20	Teleflex Telescope crown pliers	13
Pliers, Band crimping	31	Telescope activating pliers	15
Pliers, Closing loop	25	Telescope crown pliers	12 - 16
Pliers, Contouring	31	Telescope pliers	16
Pliers, Cutting	19	Tongs, Bulb	44
Pliers, Flat nose	32, 33	Tongs, Crucible	44, 45
Pliers, Pin bending	30	Tongs, Universal holding	44, 45
Pliers, Round nose	33	Tweezers	36, 41 - 43
Pliers, Telescope	16	Tweezers, Soldering	36, 43
Pliers, Telescope activating	15	Universal holding tongs	44, 45
Pliers, Telescope crown	12 - 16	Universal Crown and collar scissors	10
Pliers, Universal	30	Universal pliers	30
Pliers, Wire bending	20 - 30	Waldsachs Universal pliers	30
Pliers, Wire cutting	19, 22	Watch-makers' forceps	42
Pocket scissors	56	Wax brushes	34
Quattuor Telescope crown pliers	15	Wax knives	9
Riveting hammer	55	Waxing instruments	1
Rods, Stirring	7	Wiessner Stirring rod	7
Rotmarder Brushes	34	Wire bending pliers	20 - 30
Rotmarder-Kolinsky Brushes	34	Wire cutting pliers	19, 22
Round nose pliers	33	Zahle Modelling instruments	8
Scalpel blades	54	Zirconium forceps	41
Scalpel handles	54		
Schulz-Hammacher Telescope crown pliers	15		
Schwarz Arrow clasp bending pliers	20		

Das Hammacher Bestell-Nummern-System
The Hammacher order-number-system

Bestellbeispiel
 Ordering example

HSB 649-10

H	S	B	649	10
Hammacher	STAINLESS	Gruppe section	laufende Nummer current number	Figur oder Länge shape or size
		Scheren scissors	Blech- und Drahtscheren, gebogen Plate and wire shear, curved	100 mm 100 mm

HTC 090-11

H	T	C	090	11
Hammacher	TITAN	Gruppe section	laufende Nummer current number	Figur oder Länge shape or size
		Pinzetten tweezers	Titan-Pinzette London College Titanium-forceps London College	geriefte Spitzen serrated

HWN 110-10

H	W	N	110	10
Hammacher	Wironit	Gruppe section	laufende Nummer current number	Figur oder Länge shape or size
		Laborwerkzeug tools	Mikro-Spatel micro-spatulas	einendig single-ended



Solingen

P.K. Thomas



HSL 023-15
fig. 1 - 5

PKT-Aufwachsinstrumentensatz
mit farbcodierten Griffen + Pinsel HSL 147-00

PKT-Set of waxing instruments
with colored handles + brush HSL 147-00

HSL 024-01
fig. 1
P.K. Thomas
Wachsauftragen
und Erweichen
Apply wax and
soften

HSL 026-03
fig. 3
P.K. Thomas
Zum Verkleinern
der Kauflächen
For reducing the
areas of morsal
surfaces

HSL 028-05
fig. 5
P.K. Thomas
Zum Verkleinern der
Dreieckswülste
For reducing the
areas of trigonal
protuberances

HSL 025-02
fig. 2
P.K. Thomas
Zum Bearbeiten von
Höckerkegeln,
Höckerschragflächen
und Dreieckswülsten
For dressing conical,
sloping and trigonal
protuberances

HSL 027-04
fig. 4
P.K. Thomas
Zum Nachbearbeiten
der Höckerkegel und
Glätten der äusseren
Konturen
For finishing of conical
protuberances and
smoothing exposed
surfaces



PKT-Aufwachsinstrumente

● Einzig mögliche
Reinigungsart bei eloxierten
Alu-Instrumenten: manuell mit
Spülmittellauge (kein
Ultraschall).

Sterilisation: nur
Heißluftsterilisator. Bei allen
anderen Reinigungs-, bzw.
Sterilisationsarten wird die farbig
eloxierte Oberfläche zerstört.

PKT Waxing instruments

● Only possible type of
cleaning for anodised aluminium
instruments: manually with
detergent solution (no
ultrasonics).

Sterilisation: only hot air
steriliser. For all other types of
cleaning and/or sterilisation the
coloured anodised surface is
destroyed.

1

Modellierinstrumente Modelling instruments

Master

Master *line*

MasterLine Instrumente

- ✓ leichter, handlicher Hohlgriff
- ✓ optimale Handhabung
- ✓ unverkennbare Vorzüge



MasterLine Instruments

- ✓ light, handy hollow handle
- ✓ optimal handling
- ✓ unmistakable advantages



HWL 030-00 Hammacher-Hoyer

MasterLine
der Modellersatz für den Techniker, im Holzkasten, mit 9 Instrumenten Ihrer Wahl

MasterLine
the modelling set for the technician, in a wooden case, with 9 instruments of your choice

HWL 040-09
Holzkasten für 9 Instrumente, leer
Wooden case for 9 instruments, empty

p.3

2



Master
Line



1,3 mm 0,9 mm 1,6 mm 0,7 mm
HWL 031-01 **HWL 032-02** **HWL 033-03** **HWL 034-06**
MasterLine **MasterLine** **MasterLine** **MasterLine**
fig. 1 *fig. 2* *fig. 3* *fig. 6*

**Hammacher-Hoyer
P.K. Thomas**

Modellierinstrument für die Aufwachstechnik
Waxing instrument

HWL 035-00
MasterLine
Hammacher-Hoyer
Le Cron

Wachs- und
Modellierinstrument
Waxing instrument

HWL 036-00
MasterLine
Hammacher-Hoyer
*Discoid-Cleoid fig.
89/92*

Kombiinstrument zum
Modellieren und
Brünieren
Combined instrument
for carving and
burnishing

HWL 037-00
MasterLine
**Hammacher-
Hoyer**

Modellierinstrument
für Keramik
Modelling
instrument for
ceramics

HWL 038-03
MasterLine
Hammacher-Hoyer
Zahle

Modellierinstrument
Modelling instrument

2,5 mm
HWL 039-07
MasterLine
Hammacher-Hoyer
Beale No. 7

Modellierinstrument
Modelling instrument

1



Wironit Instrumente sind aus einer Speziallegierung gefertigt und weisen folgende Vorteile auf:

- ✓ nichtrostend
- ✓ antimagnetisch
- ✓ säurebeständig

Sie sind formschön, liegen leicht in der Hand und sind von langer Lebensdauer.



Wironit instruments are made of a special alloy and show the following advantages:

- ✓ rust resistant
- ✓ anti-magnetic
- ✓ acid resistant

They are beautifully designed and of unlimited durability.



HWH 217-00
CE

HWH 218-00
CE

HWH 220-00
no. 324
CE

HWH 221-00
no. 336
CE

HWH 225-00
Separierspatel
Separating spatula
CE

HWH 226-00
CE

HWH 227-00
CE

HWH 228-00
CE

Modellierinstrumente Modelling instruments

1



HSL 750-00
150 x 75 mm



HSL 751-00
95 x 70 mm

Glassplatten
Glass slabs

- ✓ können in der Spülmaschine bis max. 95°C gereinigt werden
- ✓ can be cleaned in the dishwasher up to max. 95°C



HSH 106-00
Achat spatula
Spatula of agate



HSH 096-00
Weston
CE

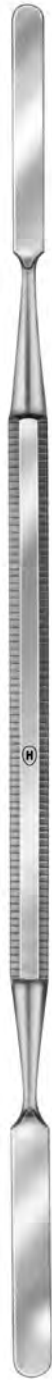

HSH 097-00
CE



HSH 098-00
CE



HSH 101-00
CE

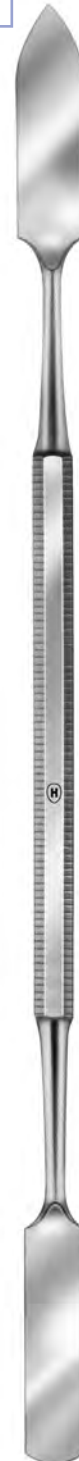

HSH 102-00
CE

Alle mit CE gekennzeichneten Produkte sind Medizinprodukte. | All products marked with CE are medical devices.

5

Einzig mögliche Reinigungsart bei eloxierten Alu-Instrumenten: manuell mit Spülmittellauge (kein Ultraschall).

Sterilisation: nur Heißluftsterilisator. Bei allen anderen Reinigungs- bzw. Sterilisationsarten wird die farbig eloxierte Oberfläche zerstört.

Only possible type of cleaning for anodised aluminium instruments: manually with detergent solution (no ultrasonics).

Sterilisation: only hot air steriliser. For all other types of cleaning and/or sterilisation the coloured anodised surface is destroyed.



HSL 029-00
Zahle

HSL 030-00
Zahle

HSL 031-00
Zahle

HSL 032-00

HSL 033-00

HSL 035-01
fig. 1S
Ward

HSL 036-07
no. 7

HSL 043-01

HSL 044-02

HSL 045-03

für Kunststoff-Verblendmaterial
for veneers

Wachs- und Modellierinstrumente mit farbcodierten Griffen
Wax and modelling carvers with coloured handles

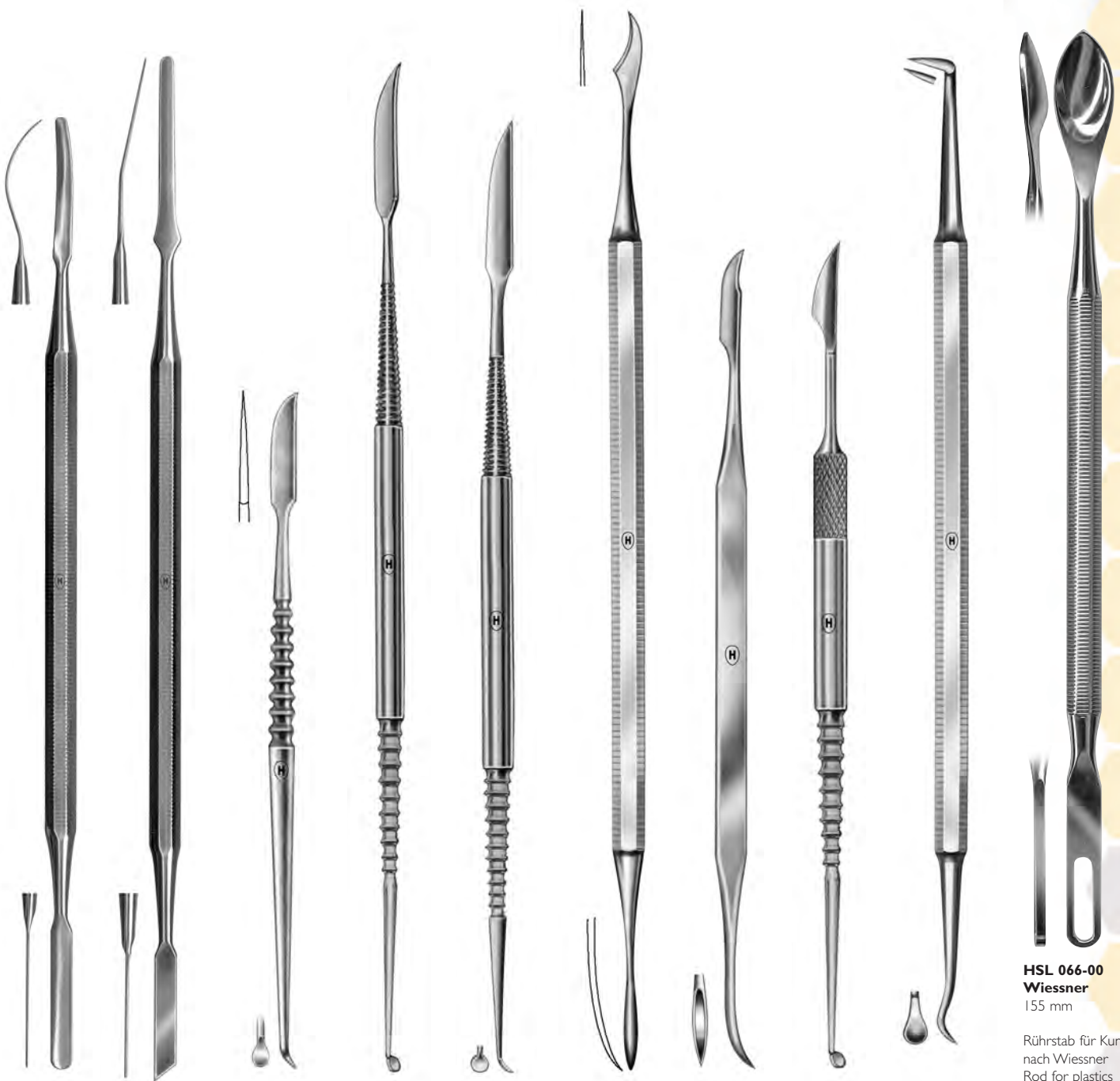

HSL 049-01
no. 1

HSL 049-02
no. 2

HSL 050-12
Mini-Le Cron

HSL 051-17
Le Cron

HSL 052-17
Le Cron

HSL 053-00

HSL 054-00
Hylin

HSL 055-00
Hylin-Le Cron

HSG 051-00
Mitchell

HSL 066-00
Wiessner
155 mm

Rührstab für Kunststoff
nach Wiessner
Rod for plastics
according to Wiessner

— K & B - Instrument —
Crown and bridge instrument

Modellierinstrumente
Modelling instruments

CE

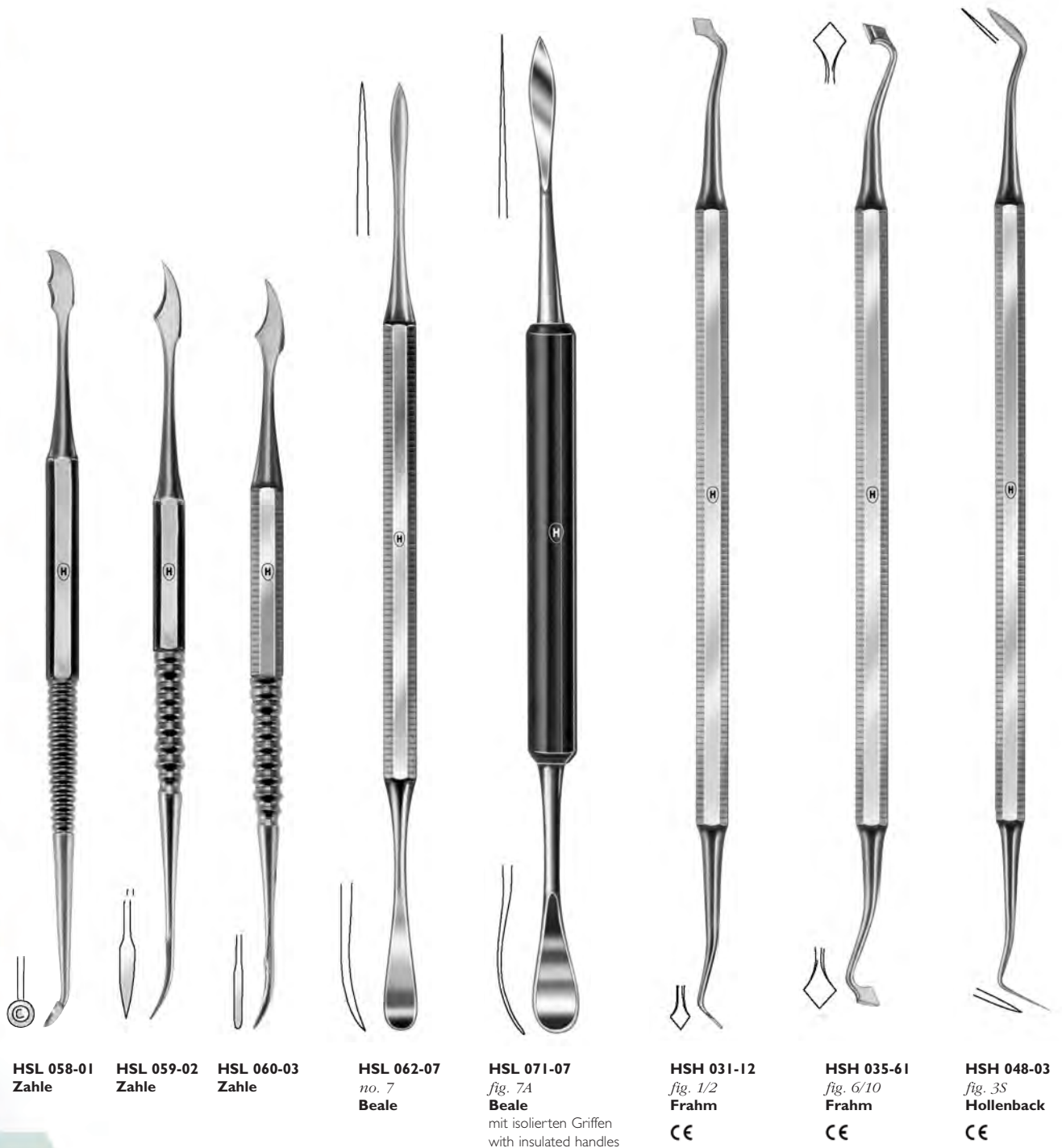



**HSL 110-00
Antkoviak**
Wachsmesser mit Holzgriff
Wax knife with wooden handle



**HWL 100-13
Fahnenstock**
130 mm
Wachsmesser aus Wironit Stahl, schwarzes Holzheft
Wax knives from Wironit steel, black wooden handle

**HSL 112-13
Fahnenstock**
130 mm
Wachsmesser aus rostfreiem Stahl, schwarzes Holzheft
Wax knives from stainless steel, black wooden handle



**HWL 101-17
Fahnenstock**
175 mm

**HSL 115-17
Fahnenstock**
175 mm



**HSL 108-13
Fahnenstock**
130 mm
Wachsmesser, Ganzmetall
Wax knife, all-metal



**HSL 109-17
Fahnenstock**
175 mm



**HSL 118-13
Lessmann**
130 mm
Wachsmesser aus rostfreiem Stahl, schwarzes Holzheft
Wax knives from stainless steel, black wooden handle



**HSL 119-17
Lessmann**
175 mm

Kronenscheren Crown and collar scissors



HSB 638-09

95 mm
Tiefziehschere, gebogen, mit feiner Zahnung
Scissors for thermoforming foils, curved, with micro serration



HSB 630-10

105 mm
sterilisierbar / sterilizable

Tiefzieh- / Folienschere, gebogen, mit feiner Zahnung, **rostfrei**. Geeignet für alle Arten von Tiefziehfolien.
Scissors for foils and splints, curved, with micro saw edge, **stainless**. Suitable for all types of foils.



HSB 653-10 Spezial

100 mm
gebogen
curved
curvas
courbes
curve



HSB 659-12 Universal

120 mm
gezahnt
saw edge



HSB 661-12

Universal
120 mm
mit Hartmetalleinsätzen
with TC inserts



HSB 662-09

90 mm
gerade
straight



HSB 663-09

90 mm
gebogen
curved

Kronenscheren
Crown and collar scissors



HSB 664-11
115 mm
gerade
straight



HSB 665-11
115 mm
gebogen
curved

Blechscheren
Plate shears



HSL 510-17
170 mm
gerade
straight



HSL 512-17
170 mm
gebogen
curved



HSL 516-14
145 mm
Universal-Schere
Universal scissors

Teleskopkronenzangen Telescope crown pliers

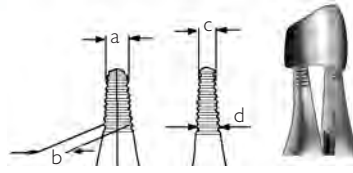

	a	b	c	d
HSL 233-12	2,8	3,0	2,2	2,4 mm
HSL 234-12	3,5	5,0	2,1	3,0 mm
HSL 235-15	4,2	5,8	3,0	4,0 mm



**HSL 233-12
Hammacher**

120 mm

für flache Teleskopkronen im Front- u. Seitenzahnbereich, mit Diamantierung
for flat telescope crowns, front and lateral area, with diamond tips



**HSL 234-12
Hammacher**

120 mm

mit Diamantierung
with diamond tips



**HSL 235-15
Böhm**

150 mm

mit Diamantierung
with diamond tips



**HSL 236-12
Teleflex Mini
nach Hoyer**
120 mm



**HSL 237-12
Teleflex
nach Hoyer**
120 mm

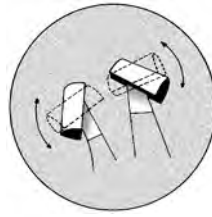

**HSL 238-15
Teleflex
nach Hoyer**
150 mm

"TELEFLEX MINI"

Um die hervorragende Haltekraft der Teleflex auch für grazile Frontzahn- und Prämolarenkronen nutzen zu können, gibt es nun die TELEFLEX MINI. Die überbotreffene Friktion der Zange wird wie auch bei der Teleflex durch eine bewegliche Haltebacke erzielt. Durch die großflächige Auflage ist auch die Deformation filigraner Kronen ausgeschlossen. Weiterhin wird eine Rotation um die Anlagepunkte vermieden und somit die diamantierte Fläche nicht punktuell abgenutzt.

"TELEFLEX MINI"

The TELEFLEX MINI has been specially developed so that the outstanding retention force of the Teleflex can also be used for delicate crowns on anterior and premolar teeth. As in the case of the Teleflex, the forceps' unrivalled friction is achieved by a movable jaw. The large contact area also prevents any deformation of even the most filigree crowns. Rotation about the points of contact is also avoided, thus preventing local abrasion of

"TELEFLEX" nach Hoyer

Die neuartige Teleskopkronenzange bringt dem/der Techniker/in höchste Perfektion und Sicherheit. Bisher nicht erreichte Haltekraft durch flächiges Anliegen der diamantierten Haltebacken auch bei sehr konischen Kronen. Keine Deformation oder Beschädigung der Krone, selbst bei großem Anpreßdruck. Höchste Lebensdauer der Diamantierung durch geringen Anpreßdruck bei großer Auflage.

"TELEFLEX" according to Hoyer

The innovative telescopic forceps for crowns bring the dental technician maximum perfection and security. Hitherto unknown retention as the diamond-lined jaws make full contact, even when highly conical crowns are involved. The crown is not deformed or damaged, even when considerable pressure is applied. Maximum service life of the diamond lining with little contact pressure and a large contact area.

Teleskopkronenzangen
Telescope crown pliers

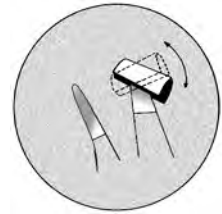
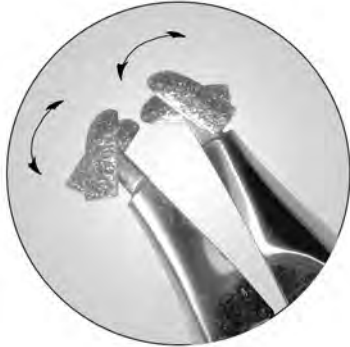
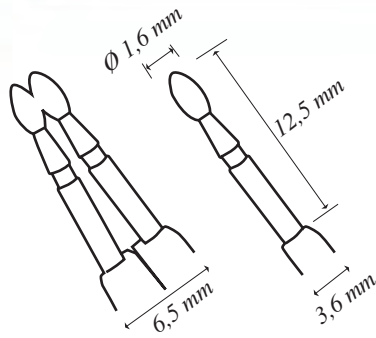
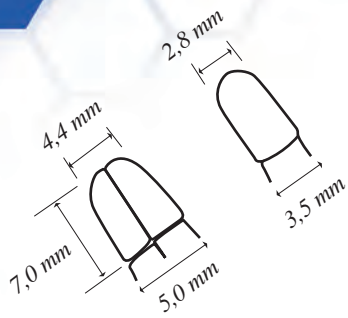

HSL 242-16

Ersatz-Spitzen (1 Paar)
Replacement tips (1 pair)



HSL 2372-12
Teleflex Grazil
120 mm
Teleskopkronenzange
Telescope crown pliers



HSL 2421-12
Hammacher
120 mm
Teleskopkronenzange
Telescope crown pliers



HSL 2361-12
Teleflex Mini
Hoyer
120 mm
Teleskopkronenzange mit Doppelfeder
Telescope crown pliers with double spring

Teleskopkronen- und Aktivierungszangen Telescope crown and activating pliers

3

Teleskopkronenzange AS-Quattuor, diamantiert

Vorteile:

- 1 Hält Kronen sicher an den Innenflächen durch neues 4-Punkt-System.
- 2 Kein Verletzen der Kronenränder.
- 3 Gefühlvolle Handhabung durch die Rückstellfedern.
- 4 Ergonomische Form.
- 5 Diamantierte Spitzen.
- 6 Rostfreier Stahl.

Telescopic crown pliers AS-Quattuor, diamond-tipped

Advantages:

- 1 Holds crowns securely on the inside surfaces with the new 4-points system.
- 2 No damage to the crown edges.
- 3 Sensitive handling by the pull-back springs.
- 4 Ergonomic shape.
- 5 Diamond-tipped.
- 6 Stainless steel.



HSL 239-17
Quattuor
Schulz - Hammacher



HSL 219-16
Hammacher

165 mm
Teleskop-Aktivierungszange für
einzel- oder freistehende Teleskope
(im freien Segment)

**HAMMACHERS Teleskop-
Aktivierungszange** ist eine
schnelle Hilfe bei friktionslosen
Teleskopen. Die Zange bildet neue
Haltekräfte entweder mit einem
oder mehreren Friktionspunkten.

Telescope activating pliers for
separately standing or detached
telescopes (in the free segment)

**HAMMACHER'S telescope
activating pliers** are a quick help
for frictionless telescopes. The pliers
create new retention forces either
with one or several friction points.

Teleskopzangen Telescope pliers

Vorteile:

- ✓ 3-Punkt-Abstützung
- ✓ kein Abkippen der Kronen
- ✓ besserer Halt
- ✓ Verteilung des Drucks auf 3 Auflagepunkte
- ✓ die Greifspitzen bestehen aus austauschbaren Diamantschleifkörpern
- ✓ leichte Handhabung

Advantages:

- ✓ 3-point-support
- ✓ no tipping of the crowns
- ✓ better maintenance
- ✓ distribution of pressure on 3 support points
- ✓ the gripper tips are of interchangeable diamond abrasive stones
- ✓ easy handling

Teleskopzange Müllerbader

Die Teleskopzange hat 3 austauschbare Greifspitzen. Zwei der Greifspitzen sind beweglich an einem Halteabschnitt der Teleskopzange gelagert – während der andere Halteabschnitt nur eine Spitze hat. Beim Betätigen der Zange suchen sich die 3 Greifspitzen – auch bei unregelmäßigen Kroneninnenwänden – automatisch eine 3-Punkt-Abstützung.

Telescope plier Müllerbader

The telescope pliers have 3 interchangeable gripping tips. Two of the gripping tips are mounted on a movable support portion of the telescope pliers – whereas the other holding section has only one tip. When using the pliers the 3 gripping tips are looking automatically for a 3-point-support – even with irregular crown inner walls.

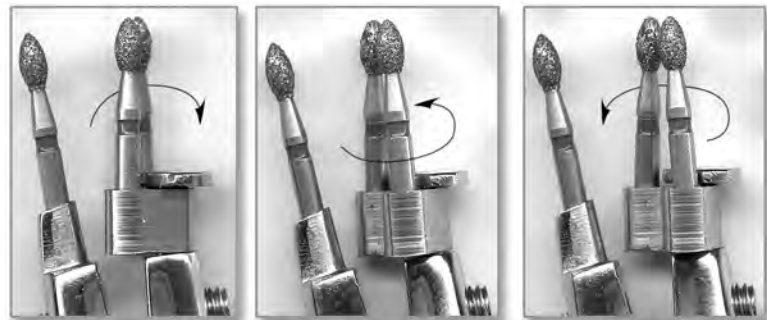

HSL 2422-12
Müllerbader
120 mm

- die Greifspitzen liegen in der Ausgangsstellung in Form eines Dreiecks nahe beieinander
- für Eckzähne und Oberkiefer Frontzähne
- the gripping tips are in the initial position in the form of a triangle near each other
- for canines and maxillary incisors

HSL 2424-99
Diamantierter Einsatz zu
HSL 2422-12 (1 Stück)
Diamond-coated insert for
HSL 2422-12 (1 piece)



HSL 245-00
Iwanson
100 mm
für Metall
for metal



HSL 245-00 + HSL 246-00
Iwanson
100 mm
Meßzirkel, Meßbereich 0-10 mm
Measuring calipers, measuring range 0-10 mm



HSL 246-00
Iwanson
100 mm
für Wachs
for wax



HSL 245-12
Interlook-Hammacher
125 mm

"Interlook"
der Taster mit den besonderen Enden,
für mehr Genauigkeit überall.
Meßbereich 0-10mm

"Interlook"
the measuring caliper with very special
tips, for more precision everywhere.
Measuring range 0-10mm



HSL 247-00
Boley
140 mm

Schieblehre
Meßbereich 0-100mm
Sliding caliper
measuring range 0-100mm

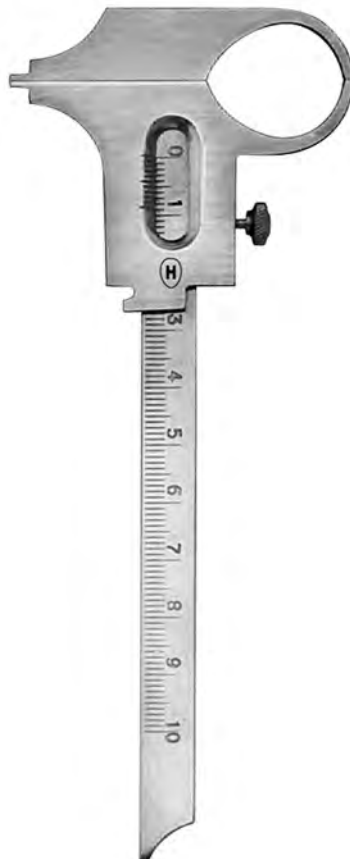

HSL 247-10
Boley
140 mm

Schieblehre
Meßbereich 0-100mm
Sliding caliper
measuring range 0-100mm



HSL 247-20
Boley
140 mm

Schieblehre
feine Spitzen, gebogen
Meßbereich 0-100mm
Sliding caliper
fine tips, curved
measuring range 0-100mm



HSL 246-15
Digital-Taschen-Meßschieber
Digital pocket caliper

HSL 246-15

- ✔ mit schmal geformten Meßschenkeln
 - ✔ mit Kreuzspitzen und Tiefenmeßstab
 - ✔ aus rostfreiem Stahl, gehärtet
 - ✔ extra große Anzeige, Ablesung 0,01mm / .0005", umschaltbar
 - ✔ Schalter ein/aus, DIN 862, Metallgehäuse, inkl. Etui., ohne Antriebsrolle
 - ✔ Meßbereich: 70 mm, Schnabellänge: 20 mm
- ✔ with narrow shaped measuring jaws
 - ✔ with cross peaks and a rod to measure the depth
 - ✔ from stainless steel, hardened and tempered
 - ✔ jumbo display, reading 0,01mm / .0005"
 - ✔ switch on / off, DIN 862, metal casing, incl. wallet, without roller
 - ✔ measuring range: 100 mm, jaws: 30 mm

HSL 252-15 ▶
15 cm / 6 inch

HSL 252-20
20 cm / 8 inch

rostfrei / sterilisierbar
stainless / sterilizable

Messlineal aus Metall
Measuring ruler of metal



HSL 250-00
Zehntel-Maß-Uhr
Dial caliper

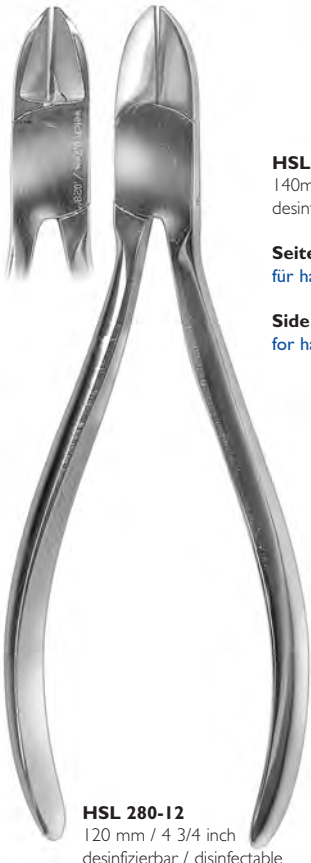

HSL 497-14 ▶
140mm / 5 1/2 inch
desinfizierbar / disinfactable

Seitenschneider verchromt
für harten Draht bis 1,2mm / .047" Ø max.

Side nippers chromium plated
for hard wire until 1,2mm / .047" Ø max.



HSL 280-12
120 mm / 4 3/4 inch
desinfizierbar / disinfactable

Seitenschneider verchromt
für weichen Draht bis 0,7 mm / .028" Ø max.

Side nippers chromium plated
for soft wire up to 0,7 mm / .028" Ø max.



HSL 278-11
115 mm / 4-1/2 inch
desinfizierbar / disinfactable

Seitenschneider
Chrom-Vanadium.
Rockwell-Härte: 65 HRC,
für weichen Draht bis 0,7mm / .028" Ø max.

Cutting pliers
Chrome-Vanadium steel.
Rockwell hardness: 65 HRC,
for soft wire until 0,7mm / .028" Ø max.



HSL 519-18
Fantastico
200mm / 7 7/8 inch
desinfizierbar / disinfactable

Hebel-Kraftseitenschneider
mit einer Kraftersparnis von ca. 45%
für harten Draht bis 1,5mm / .059" Ø max.

Heavy-duty lever cutting nipper
power saving of about 45%
for hard wire until 1,5mm / .059" Ø max.

◀ **HSL 504-16**
no. 177
165mm / 6 1/2 inch
desinfizierbar / disinfactable

Hebelseitenschneider
für harten Draht bis 1,2mm / .047" Ø max.

Double action side nippers
for hard wire until 1,2mm / .047" Ø max.



Solingen



HSL 374-12

Schwarz

125 mm / 4 7/8 inch
sterilisierbar / sterilizable

Pfeilformzange

für harten Draht bis 0,7 mm / .028" Ø max.

Arrow clasp forming pliers

for hard wire up to 0,7 mm / .028" Ø max.



HSL 375-13

Schwarz

130 mm / 5 1/8 inch
sterilisierbar / sterilizable

Pfeilknickzange

für harten Draht bis 0,7 mm / .028" Ø max.

Arrow clasp bending pliers

for hard wire up to 0,7 mm / .028" Ø max.

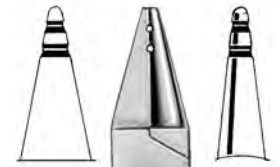

HSL 368-13

135 mm / 5 3/8 inch
sterilisierbar / sterilizable

für Halteelemente

für harten Draht bis 0,7 mm / .028" Ø max.

for retaining elements

for hard wire up to 0,7 mm / .028" Ø max.

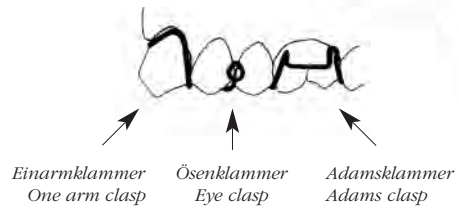
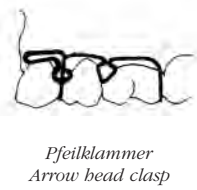
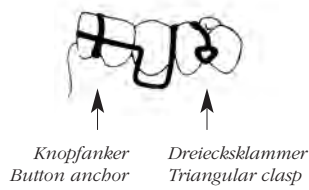

HSL 369-13
Adams modif.
135 mm / 5 3/8 inch
sterilisierbar / sterilizable

Für Halteelemente, Dreiecksklammern, Adamsklammern und Protrusionsfedern
für harten Draht von 0,7 mm / .028" bis 0,9 mm / .035" Ø max.

For retaining elements, Triangular clasp, Adams clasp and spring of the protrusion
for hard wire from 0,7 mm / .028" up to 0,9 mm / .035" Ø max.



HSL 362-12
Adams modif.
125 mm / 4 7/8 inch
sterilisierbar / sterilizable

3D-Zange nach Reschke
3D pliers acc. to Reschke



HSL 359-13
Adams modif.
135 mm / 5 3/8 inch
sterilisierbar / sterilizable

Speziell für Dreiecksklammern, Adamsklammern und Protrusionsfedern, mit zusätzlicher Komforttrille zum Nachfassen
für harten Draht von 0,7 mm / .028" bis 0,9 mm / .035" Ø max.

Especially for triangular clasp, Adams clasp and spring of the protrusion, with additional comfort groove for intrusion
for hard wire from 0,7 mm / .028" up to 0,9 mm / .035" Ø max.

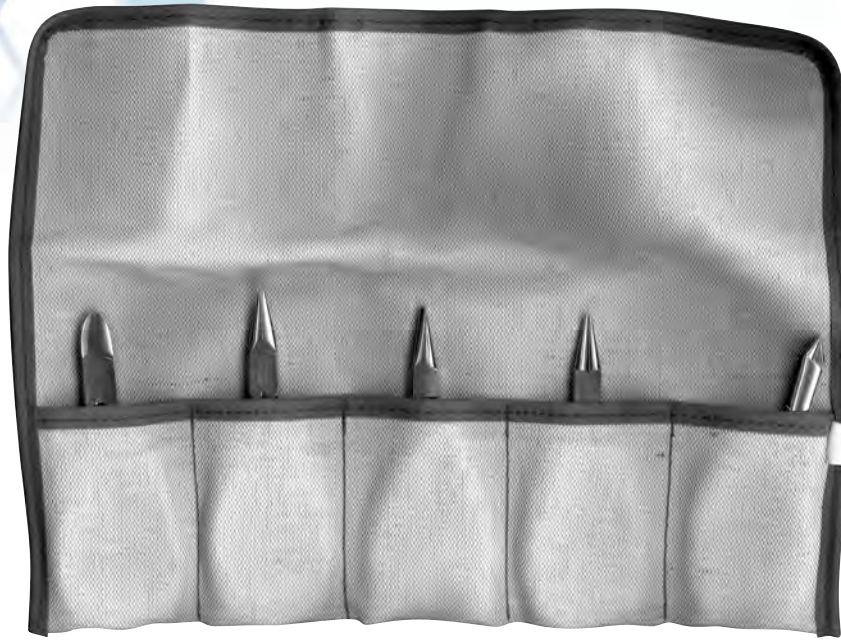

HSL 536-00
5 Technik-Zangen im Etui
5 technical pliers in case

HSL 536-01
Etui allein
case only

- Alle Griffe der Zangen mit schwarzem Plastiküberzug
- ✓ nur desinfizierbar
- All handles of the pliers with a black plastic coat
- ✓ only disinfected



HSL 536-10
140 mm / 5 1/2 inch

Seitenschneider verchromt
für weichen Draht bis 0,9 mm /
.035" Ø max.
Side nippers chromium plated
for soft wire til 0,9 mm /
.035" Ø max.

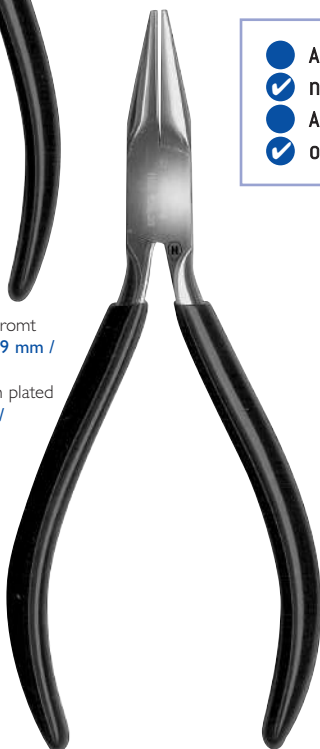

HSL 536-20
135 mm / 5 3/8 inch

Flachzange verchromt
Flat nose pliers chromium plated



HSL 536-30
135 mm / 5 3/8 inch

Draht- und Bügelbiegezeuge verchromt
für Draht bis 0,7 mm / .028" Ø max.
Clasp and wire bending pliers chromium plated
for wire up to 0,7 mm / .028" Ø max.



HSL 536-40
135 mm / 5 3/8 inch

Rundzange, verchromt
Round nose pliers, chromium plated



HSL 536-50
Aderer
130mm / 5 1/8 inch

Draht- und Klammerbiegezeuge
rostfrei
Wire and clasp bending pliers
stainless steel



HSL 377-13
Schwarz
135 mm / 5 3/8 inch
sterilisierbar / sterilizable

Draht- und Bügelbiegezaugen
für harten Draht bis 0,7 mm / .028" Ø max.

Sling, clasp and wire bending pliers
for hard wire up to 0,7 mm / .028" Ø max.

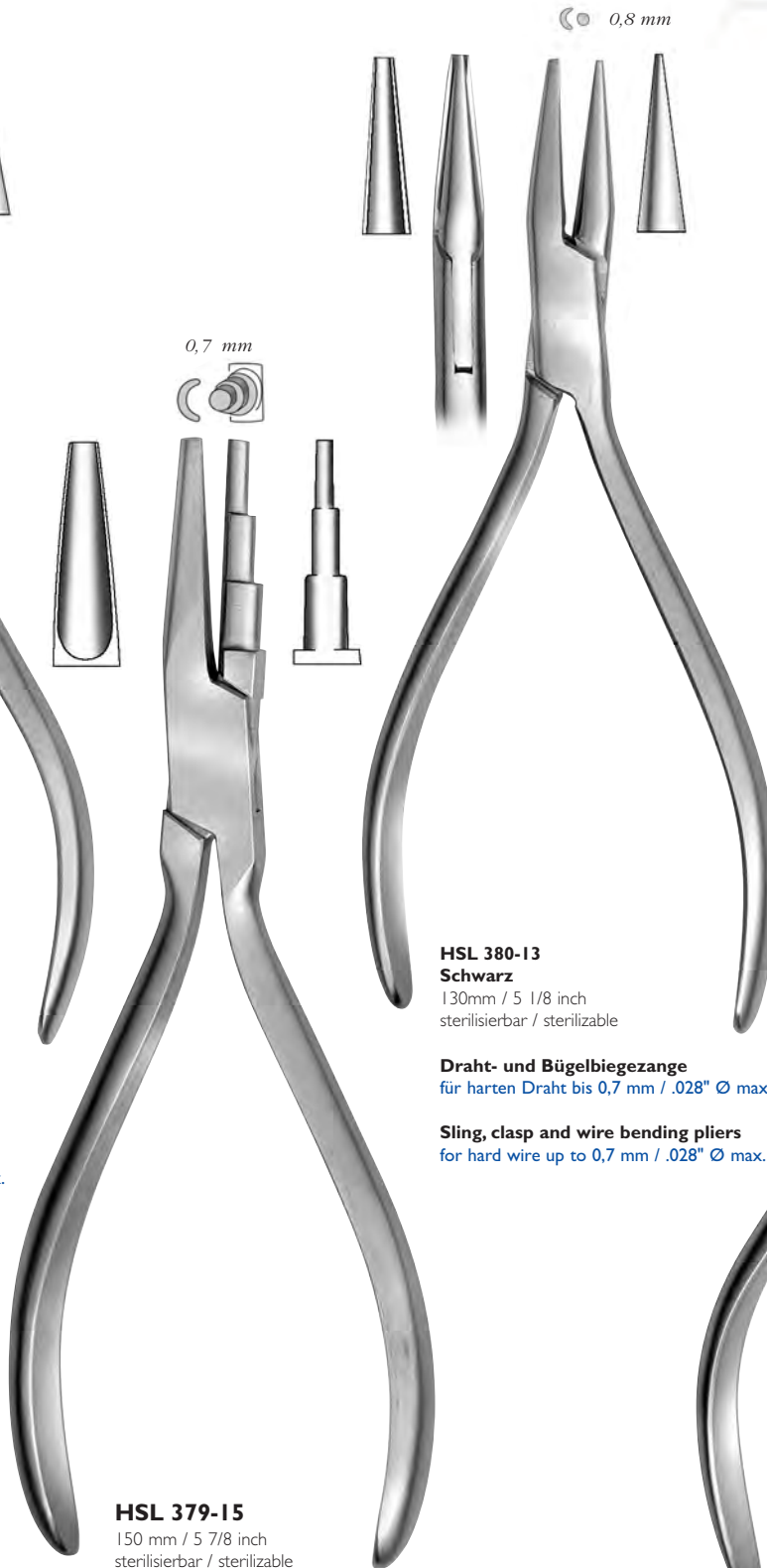

HSL 379-15
150 mm / 5 7/8 inch
sterilisierbar / sterilizable

Draht- und Bügelbiegezaugen
für harten Draht bis 0,7 mm / .028" Ø max.

Sling, clasp and wire bending pliers
for hard wire up to 0,7 mm / .028" Ø max.



HSL 380-13
Schwarz
130mm / 5 1/8 inch
sterilisierbar / sterilizable

Draht- und Bügelbiegezaugen
für harten Draht bis 0,7 mm / .028" Ø max.

Sling, clasp and wire bending pliers
for hard wire up to 0,7 mm / .028" Ø max.



HSL 382-13
Schwarz
135 mm / 5 3/8 inch
sterilisierbar / sterilizable

Draht- und Bügelbiegezaugen
für Draht bis 1,0 mm / .039" Ø max.

Sling, clasp and wire bending pliers
for wire up to 1,0 mm / .039" Ø max.

Drahtbiegezaugen Wire bending pliers



HSL 386-13
Schwarz
135 mm / 5 3/8 inch
sterilisierbar / sterilizable

Draht- und Bügelbiegezauge
für harten Draht bis 0,7 mm / .028" Ø max.

Sling, clasp and wire bending pliers
for hard wire up to 0,7 mm / .028" Ø max.

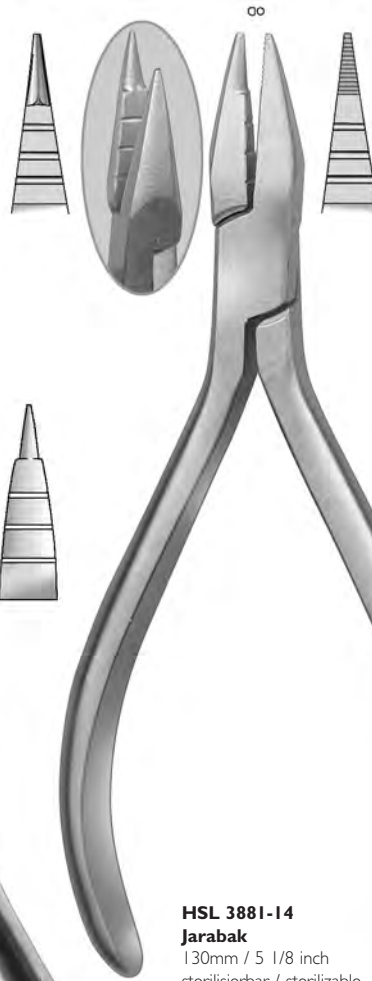

HSL 388-13
Jarabak
135 mm / 5 3/8 inch
sterilisierbar / sterilizable

Draht- und Bügelbiegezauge
für harten Draht bis 0,5 mm / .020" Ø max.

Wire and bar bending pliers
for hard wire until 0,5 mm / .020" Ø max.

Tips measure

	
0,71 mm .028"	0,71 mm .028"



HSL 364-13
Jarinda
125 mm / 4 7/8 inch
sterilisierbar / sterilizable

Draht- und Bügelbiegezauge

- universell einsetzbar
- ermöglicht ein leichtes und bequemes Arbeiten im Labor

für alle handelsüblichen Drähte bis 0,8 mm / .031" (hart und federhart) Ø max.

Wire and bar bending pliers

- universally applicable
- allows easy and comfortable working in the laboratory

for all commercially available wires up to 0,8 mm / .031" (hard and spring hard) Ø max.

HSL 3881-14
Jarabak
130mm / 5 1/8 inch
sterilisierbar / sterilizable

Draht- und Bogenbiegezauge (Light Wire)

Feine Riefen auf dem geraden Maulteil und drei Präzisionsrillen, erlauben akkurates Biegen und Schließen von Ösen mit sicherem Halt. Besonders zu empfehlen bei der Verwendung von Light Wire Drähten.

Drahtstärken rund, quadratisch und rechteckig bis zu 0,5 mm / .020" Ø max.

Light wire bending pliers

Fine serrations on square beak and three precision grooves allow accurate bending & closing of loops with a secure grip.

Especially good when used on light wire sizes.
Bends round, square and rectangular wires up to 0,5 mm / .020" Ø max.

max. 0,7 mm
Ø

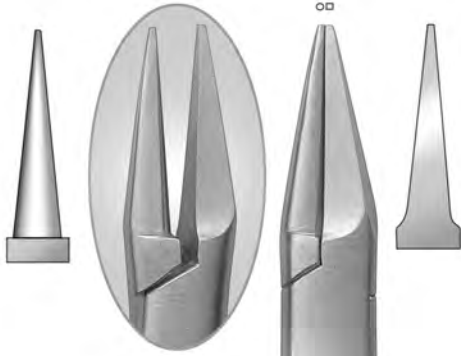

max. 0,6 mm

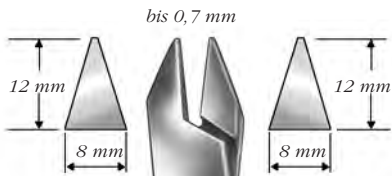

HSL 397-13
Ash no. 64
130mm / 5 1/8 inch

Draht- und Bogenbiegezeuge
Sling, clasps and wire bending pliers

HSL 399-15
Ash no. 65
150 mm / 5 7/8 inch

Draht- und Bogenbiegezeuge
Sling, clasps and wire bending pliers

max. 0,7 mm



HSL 415-12
Nance
130mm / 5 1/8 inch
sterilisierbar / sterilizable

Schlaufenbiegezeuge
für harten Draht bis 0,7 mm / .028" Ø max.
Closing loop pliers
for hard wire up to 0,7 mm / .028" Ø max.

HSL 417-13
130 mm / 5-1/8 inch
sterilisierbar / sterilizable

Loop-Biegezeuge
für harten Draht bis max.
0,6 mm / .024" Ø max.

Closing loop pliers
for hard wire until max.
0,6 mm / .024" Ø max.

Drahtbiegezaugen Wire bending pliers

max. 0,7 mm

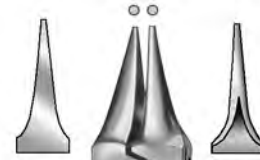

max. 0,7 mm



HSL 403-12 Angle modif.

125mm / 4 7/8 inch
sterilisierbar / sterilizable

Draht- und Bogenbiegezauge
für harten Draht bis 0,7 mm / .028" Ø max.

Sling, clasps and wire bending pliers
for hard wire up to 0,7 mm / .028" Ø max.

max. 0,7 mm



HSL 404-13 Adams

130mm / 5 1/8 inch
sterilisierbar / sterilizable

Draht- und Bogenbiegezauge
für harten Draht bis 0,7 mm / .028" Ø max.

Sling, clasps and wire bending pliers
for hard wire up to 0,7 mm / .028" Ø max.

HSL 401-13 no. 139

Angle / Bird Beak
130mm / 5 1/8 inch
sterilisierbar / sterilizable

Draht- und Bogenbiegezauge
für harten Draht bis 0,7 mm / .028" Ø max.

Sling, clasps and wire bending pliers
for hard wire up to 0,7 mm / .028" Ø max.

HSL 406-14 ▶ Tungsten Carbide Inserts (TC) Adams modif.

120 mm / 4 3/4 inch
sterilisierbar / sterilizable

Draht- und Bogenbiegezauge
für harten Draht bis 0,7 mm / .028" Ø max.

**Sling, clasps and wire
bending pliers**
for hard wire up to 0,7 mm / .028" Ø max.

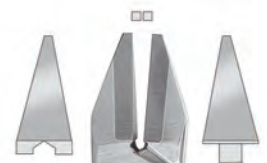



max. 0,4 mm

HSL 411-11
Aderer
115 mm / 4-1/2 inch
sterilisierbar / sterilizable

Draht- und Klammerbiegezaugen
Besonders fein und grazil
ausgearbeitete Arbeitsenden –
besonders geeignet für alle
Thermo- und NiTi-Bögen.
für Drähte der Stärken
0,36 mm / .014" und
0,4 mm / .016" Ø

Wire and clasp bending pliers
Particularly fine and delicate
working ends – especially suitable
for all thermal and NiTi-arches.
for wire of thickness
0,36 mm / .014" and
0,4 mm / .016" Ø

CE



max. 0,7 mm



HSL 413-11
Aderer
115 mm / 4-1/2 inch
sterilisierbar / sterilizable

Draht- und Klammerbiegezaugen
nach Büscher, mit Riefen
für harten Draht bis 0,7 mm / .028" Ø max.

Wire and clasp bending pliers
acc. to Büscher, with grooves
for hard wire until 0,7 mm / .028" Ø max.

CE



max. 0,7 mm

HSL 419-11
Aderer
115 mm / 4-1/2 inch
sterilisierbar / sterilizable

Draht- und Klammerbiegezaugen
für harten Draht bis 0,7 mm / .028" Ø max.

Wire and clasp bending pliers
for hard wire until 0,7 mm / .028" Ø max.

CE



max. 0,7 mm

HSL 420-12
Hammacher-Aderer
125mm / 4 7/8 inch
sterilisierbar / sterilizable

Draht- und Klammerbiegezaugen
für harten Draht bis 0,7 mm / .028" Ø max.

Wire and clasp bending pliers
for hard wire up to 0,7 mm / .028" Ø max.

CE

Drahtbiegezangen Wire bending pliers



“GRIFFI”-Zangen von Hammacher

- ✓ angenehm in der Handhabung
- ✓ geringerer Kraftaufwand
- ✓ ermüdungsfreies Arbeiten
- ✓ fest im Griff

Hammachers “GRIFFI”-forceps

- ✓ pleasant in handling
- ✓ less effort
- ✓ working without getting fatigue
- ✓ sure grip

max. 0,9 mm



HSL 423-12
no. 200
Aderer
125mm / 4 7/8 inch
sterilisierbar / sterilizable

Draht- und Klammerbiegezeuge
für harten Draht bis 0,9 mm / .035" Ø max.

Wire and clasp bending pliers
for hard wire up to 0,9 mm / .035" Ø max.

CE

max. 0,7 mm



HSL 422-12
125mm / 4 7/8 inch
sterilisierbar / sterilizable

Draht- und Klammerbiegezeuge
für harten Draht bis 0,7 mm / .028" Ø max.

Wire and clasp bending pliers
for hard wire up to 0,7 mm / .028" Ø max.

CE

max. 0,91 mm



HSL 4231-13
no. 200
Typ Aderer
130mm / 5 1/4 inch
sterilisierbar / sterilizable

Draht- und Klammerbiegezeuge
Für die Anpassung von Klammern und Bogendrähten, ohne diese zu beschädigen.
für harten Rund- und Profildraht bis 0,9 mm / .035" Ø max.

Wire and clasp bending pliers
For adjusting clasps and archwires without marring the archwire.
for round, square and rectangular wires up to 0,9 mm / .035" Ø max.

CE



HSL 426-14
no. 100
Aderer
140mm / 5 1/2 inch
sterilisierbar / sterilizable

Draht- und Bügelbiegezauge
für harten Draht bis 1,5 mm / .059" Ø max.

Clasp and wire bending pliers
for hard wire up to 1,5 mm / .059" Ø max.

für Gesichtsbogen geeignet
suitable for face-bows



HSL 428-21
Malotky
210mm / 8 1/4 inch
sterilisierbar / sterilizable

Draht- und Bügelbiegezauge
für harte Profildrähte bis
max. 3,0 x 1,5 mm .118" x .059"

Clasp and wire bending pliers
for hard profiled wires up to
max. 3,0 x 1,5 mm .118" x .059"



HSL 429-16
Mc Kellops
160mm / 6 1/4 inch
sterilisierbar / sterilizable

Bügelbiegezauge
für harten Draht bis 1,5 mm / .059" Ø max.

Bar bending pliers
for hard wire up to 1,5 mm / .059" Ø max.



HSL 431-15
Waldsachs
 150mm / 5 7/8 inch
 sterilisierbar / sterilizable

Universalzange

Biegt : harten Draht bis 1,0 mm / .039" Ø max.
 harten Profildraht bis 1,3 x 0,65 mm / .051" x .026" max.
Schneidet: harten Draht bis 0,7 mm / .028" Ø max.

Universal pliers

Bends: hard wire up to 1,0 mm / .039" Ø max.
 hard profiled wires up to 1,3 x 0,65 mm / .051" x .026" max.
Cuts: hard wire up to 0,7 mm / .028" Ø max.

verwendbar als:

- 1) Kramponzange
- 2-3) Klammerbiegezeuge
- 4) Bügelbiegezeuge
- 5) Kneifzange

to be used as:

- 1) Pin bending pliers
- 2-3) Clasp bending pliers
- 4) Bar bending pliers
- 5) Cutting pliers



HSL 433-15
 155mm / 6 1/8 inch
 sterilisierbar / sterilizable

Universal-Kramponzange

Biegt: harten Draht bis 0,9 mm / .035" Ø max.
Schneidet: harten Draht bis 0,7 mm / .028" Ø max.

Universal pin bending pliers

Bends: hard wire up to 0,9 mm / .035" Ø max.
Cuts: hard wire up to 0,7 mm / .028" Ø max.



HSL 436-15
 155mm / 6 1/8 inch
 sterilisierbar / sterilizable

Universal-Kramponzange

mit sehr graziilen Arbeitsenden

Biegt: harten Draht bis 0,9 mm / .035" Ø max.
Schneidet: harten Draht bis 0,7 mm / .028" Ø max.

Universal pin bending pliers

with very delicate working ends

Bends: hard wire up to 0,9 mm / .035" Ø max.
Cuts: hard wire up to 0,7 mm / .028" Ø max.

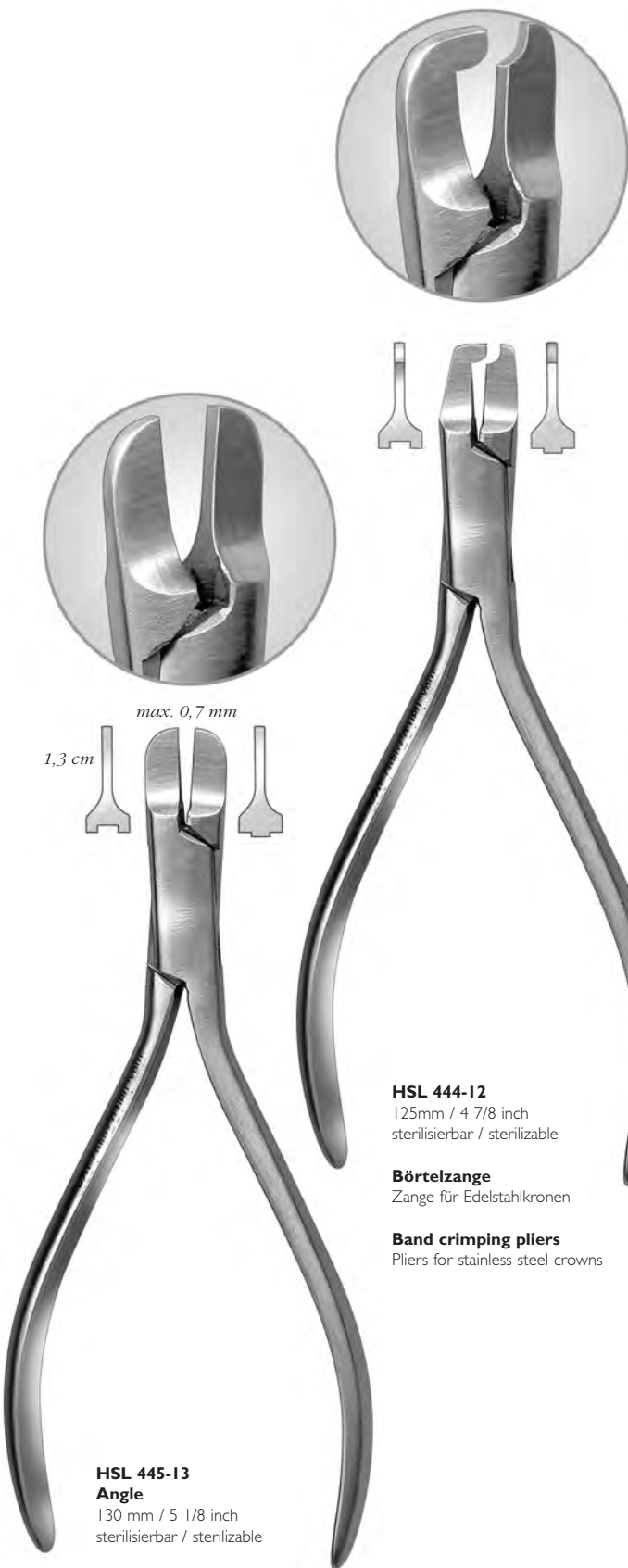

HSL 445-13
Angle
 130 mm / 5 1/8 inch
 sterilisierbar / sterilizable

Bogenbiegezange
 für harten Draht bis 0,7 mm / .028" Ø max.

Arch forming pliers
 for hard wire up to 0,7 mm / .028" Ø max.



HSL 444-12
 125mm / 4 7/8 inch
 sterilisierbar / sterilizable

Börtelzange
 Zange für Edelstahlkronen

Band crimping pliers
 Pliers for stainless steel crowns



HSL 446-12
 120 mm / 4 3/4 inch
Angle / Tweed
 sterilisierbar / sterilizable

Bogenformzange / 2 Stufenzange
 Das kürzere Maul ermöglicht eine bessere Kontrolle und einen sicheren Griff. Vorzüglich zum Arbeiten an Bogendraht.

Drahtstärken rund, quadratisch und rechteckig bis 0,56 mm x 0,7 mm / .020 x .028" max.

Tweed arch pliers / 2 Step pliers
 Shorter jaws give better control and grip. Excellent for detailing an arch wire.

Bends round, square and rectangular wires up to 0,56 mm x 0,7 mm / .020 x .028" max.



HSL 454-13
Johnson
 no. 114 N
 130 mm / 5 1/8 inch

Konturenzange
Contouring plier

Flachzangen Flat nose pliers

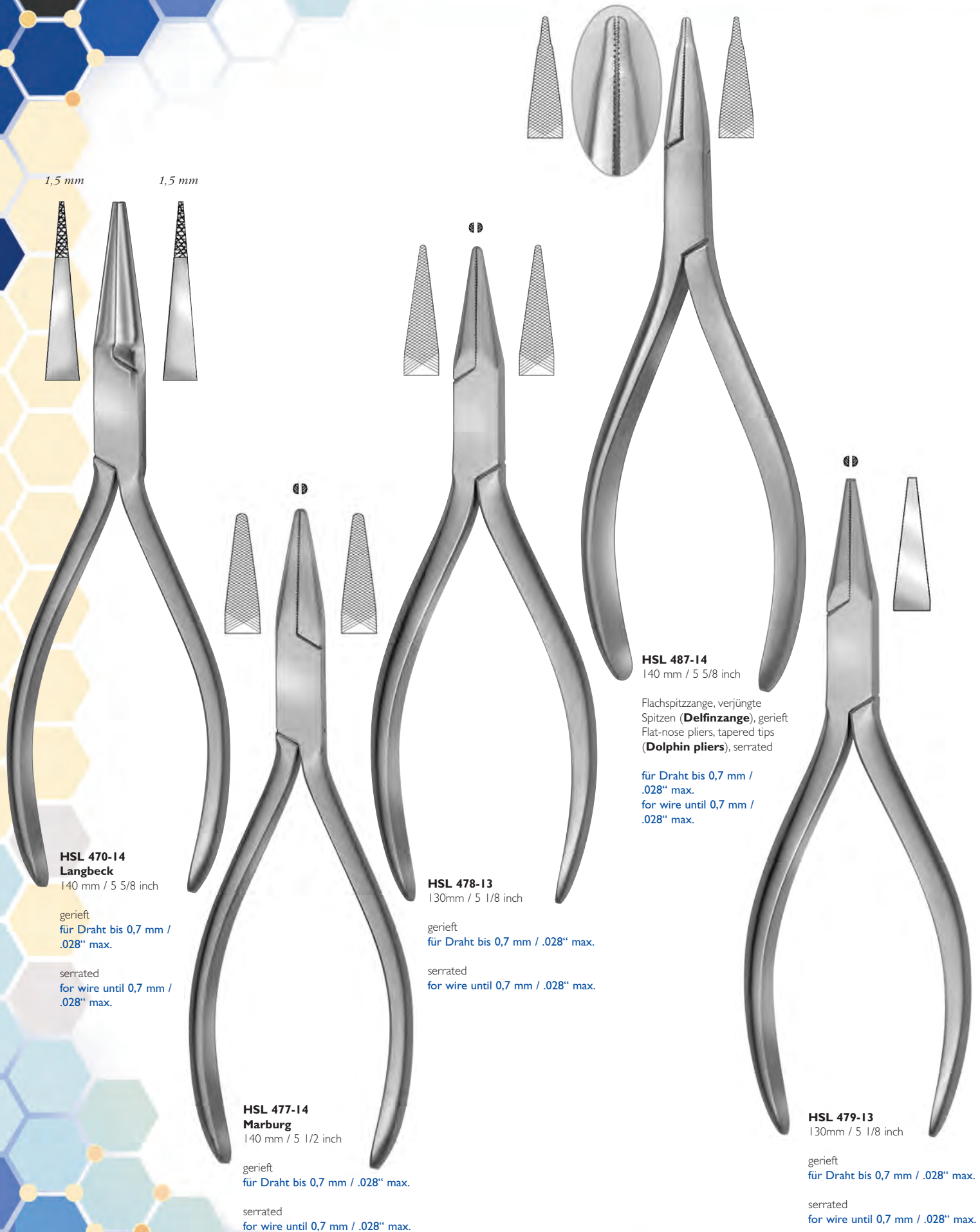

1,5 mm

1,5 mm

HSL 470-14 Langbeck

140 mm / 5 5/8 inch

gerieft
für Draht bis 0,7 mm /
.028" max.serrated
for wire until 0,7 mm /
.028" max.

HSL 477-14 Marburg

140 mm / 5 1/2 inch

gerieft
für Draht bis 0,7 mm / .028" max.serrated
for wire until 0,7 mm / .028" max.

HSL 478-13

130mm / 5 1/8 inch

gerieft
für Draht bis 0,7 mm / .028" max.serrated
for wire until 0,7 mm / .028" max.

HSL 487-14

140 mm / 5 5/8 inch

Flachspitzzange, verjüngte
Spitzen (**Delfinzange**), gerieft
Flat-nose pliers, tapered tips
(**Dolphin pliers**), serratedfür Draht bis 0,7 mm /
.028" max.
for wire until 0,7 mm /
.028" max.

HSL 479-13

130mm / 5 1/8 inch

gerieft
für Draht bis 0,7 mm / .028" max.serrated
for wire until 0,7 mm / .028" max.



HSL 483-13
 130mm / 5 1/8 inch
 sterilisierbar / sterilizable

Flachzange mit Führungskerbe
 gerieft
 für Draht bis 0,7 mm / .028" max.

Flat nose pliers with guide notch,
 serrated
 for wire until 0,7 mm / .028" max.



HSL 481-12
 120 mm / 4 3/4 inch
 sterilisierbar / sterilizable

Flachspitzzängchen, schmal, gerieft
 für harten Draht bis 0,5 mm / .020" Ø max.

Flat nose pliers, pointed, narrow, serrated
 for hard wire until 0,5 mm / .020" Ø max.

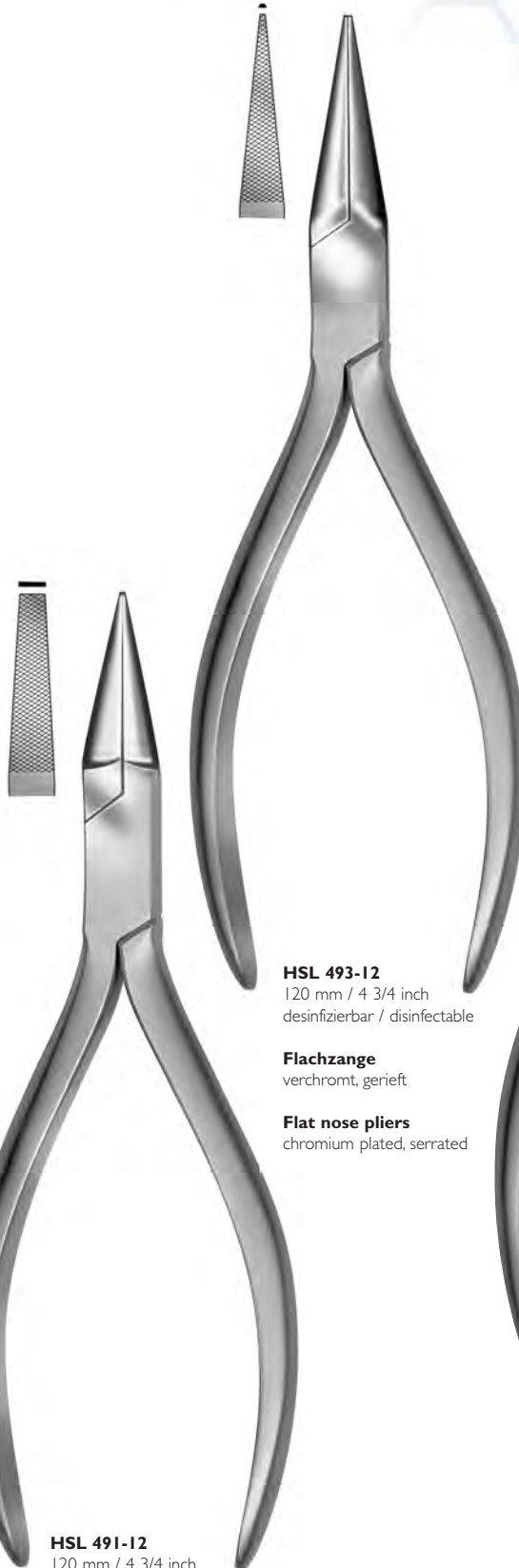

HSL 493-12
 120 mm / 4 3/4 inch
 desinfizierbar / disinfectable

Flachzange
 verchromt, gerieft

Flat nose pliers
 chromium plated, serrated

HSL 491-12
 120 mm / 4 3/4 inch
 desinfizierbar / disinfectable

Flachzange
 verchromt, gerieft
Flat nose pliers
 chromium plated, serrated



HSL 494-12
 120 mm / 4 3/4 inch
 desinfizierbar / disinfectable

Rundzängchen
 verchromt, glatt

Round nose pliers
 chromium plated, smooth



HSL 551-00 **HSL 552-01** **HSL 553-02** **HSL 554-03** **HSL 555-04**
fig. 0 *fig. 1* *fig. 2* *fig. 3* *fig. 4*

Rotmarder

HSL 603-00 **HSL 604-01** **HSL 605-02** **HSL 606-03** **HSL 607-04**
Rotmarder-Kolinsky

HSL 556-05 **HSL 557-06** **HSL 558-07** **HSL 559-08** **HSL 560-10**
fig. 5 *fig. 6* *fig. 7* *fig. 8* *fig. 10*

Rotmarder

HSL 608-05 **HSL 609-06** **HSL 610-07** **HSL 611-08** **HSL 612-10**
Rotmarder-Kolinsky

HSL 562-06

fig. 6

Wachspinsel zum Glätten der Oberflächen
 Wax brush for smoothing of the surfaces

HSL 147-00

fig. 00

Doppelendiger Aufwachspinsel:
 eine Seite reines Fehhaar; zweite Seite Borsten
 Double ended wax-up brush:
 one side pure squirrel hair; second side bristles



ERGO BRUSH

Dieser einzigartige Griff für Pinsel unterschiedlicher Größen ermöglicht dank der geneigten Ausführung im Gegensatz zu den herkömmlichen Pinseln, bei denen der Griff den Zahn verdeckt und der Nutzer gezwungen ist, ständig seine Position zu verändern, die ständige freie Sicht auf das Werkstück und die Aufrechterhaltung der korrekten Körperhaltung. Durch das einfache Drehen der Spitze werden alle Punkte erreicht, an denen gearbeitet werden soll, um zu modellieren bzw. Material oder Farbe aufzutragen.

ERGO BRUSH

Due to the inclined design this unique handle for brushes of various sizes allows – contrary to conventional brushes where the handle covers the tooth and the user is forced to constantly change his position – the constant clear view of the work piece and the maintenance of proper body position. By simply rotating the tip all points to be worked on will be reached to model or to apply material or colour.



- Nur in Kombination zu nutzen!
- Use only in combination!



HSL 522-00

Pinselkopf Gr: 0
Brush head size 0



HSL 522-01

Pinselkopf Gr: 1
Brush head size 1



HSL 522-02

Pinselkopf Gr: 2
Brush head size 2



HSL 522-03

Pinselkopf Gr: 3
Brush head size 3



HSL 522-04

Pinselkopf Gr: 4
Brush head size 4



HSL 522-05

Pinselkopf Gr: 5
Brush head size 5



HSL 522-06

Pinselkopf Gr: 6
Brush head size 6



HSL 522-07

Pinselkopf Gr: 7
Brush head size 7



HSL 522-08

Pinselkopf Gr: 8
Brush head size 8

HSL 521-71

ERGO-BRUSH Pinselhalter
für Pinselköpfe Gr: 5 - 8

ERGO-BRUSH Brush holder
for brush heads size 5 - 8

HSL 520-06

ERGO-BRUSH Pinselhalter
für Pinselköpfe Gr: 0 - 4

ERGO-BRUSH Brush holder
for brush heads size 0 - 4



HSL 563-00

Halterung für Pinsel
Brush Station



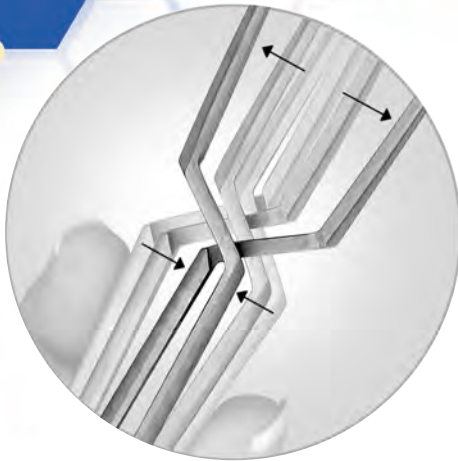

4 mm

4 mm



HSC 510-16
160 mm

Lötpinzette, gekreuzt
Soldering tweezers, cross over type

HSC 511-16
160 mm



HWC 016-04
170 mm
Pinzette, gewinkelt,
mit glatten Spitzen
Tweezers, angled,
with smooth tips

CE



HSC 011-04
170 mm
fig. 4
Pinzette, parallelfassend,
abgewinkelt, mit glatten Spitzen
Forceps, parallel gripping,
angled, with smooth tips

CE



HSC 517-17
Hammacher
170 mm



HSC 519-17
Hammacher
170 mm
mit Einstellschraube
Adjustable by screw

— Kronenhaltepinzetten, diamantiert
— Crown holding forceps, diamond tips



HSE 010-09
Micro-Hartmann
90 mm
Klemme, sehr fein, gerade
Forceps, very delicate, straight

CE



HSE 017-12
Micro-Halsted
125 mm
Klemme, sehr fein, gebogen
Forceps, very delicate, curved

CE

HSE 016-12
Micro-Halsted
125 mm
Klemme, sehr fein, gerade
Forceps, very delicate, straight

CE



HSE 011-09
Micro-Hartmann
90 mm
Klemme, sehr fein, gebogen
Forceps, very delicate, curved

CE



HSE 022-12
Halsted-Mosquito
120 mm
Klemme, fein, gerade
Clamp, delicate, straight

CE

HSE 023-12
Halsted-Mosquito
Klemme, fein, gebogen
Clamp, delicate, curved

CE

Solingen

HSL 572-00

HSL 573-00

HSL 574-00
Modellierinstrumente für Keramik
Modelling carvers for ceramics

HSL 576-00

Doppelendiges Instrument mit Spatel zum Anmischen und grobem Formen, einem kleinen Löffel und einem geriffelten Griff zum vibrierenden Verdichten
 Double ended instrument with mixing spatula and for roughly forming and with a small spoon. The handle with rings around is for condensing by vibrating

HSL 577-00

Kombiniertes Instrument mit flexiblem Anmischspatel, mittelharterm Plastik-Kopf zum Klopfenden und geriffeltem Teil zum vibrierenden Verdichten
 Combined instrument with flexible mixing spatula and a middle hard plastic head for condensing by tapping while the middle part of instruments with rings around is intended for the other way of condensing, as by vibration



HWB 202-20
 125 mm
 Modelliermesser
 Modelling knife
CE



HSB 800-12
 125 mm
 Modelliermesser, sehr fein
 Modelling knife, very delicate
CE



HSH 563-00
 Glasspatel
 Glass spatula



HSL 566-00
 Separierfeile, fein
 Separating file, fine



HSB 018-11
 115 mm
 Folienschere, gerade, mit feiner Zahnung
 Foil scissors, straight, with micro serration



HSL 242-16
 Ersatz-Spitzen (1 Paar)
 Replacement tips (1 pair)



HSL 242-06
 160 mm
 Klemme für Keramik-Arbeiten, gebogen,
 mit austauschbaren, diamantierten Spitzen
 Forceps for ceramic work, curved,
 with interchangeable diamond tips

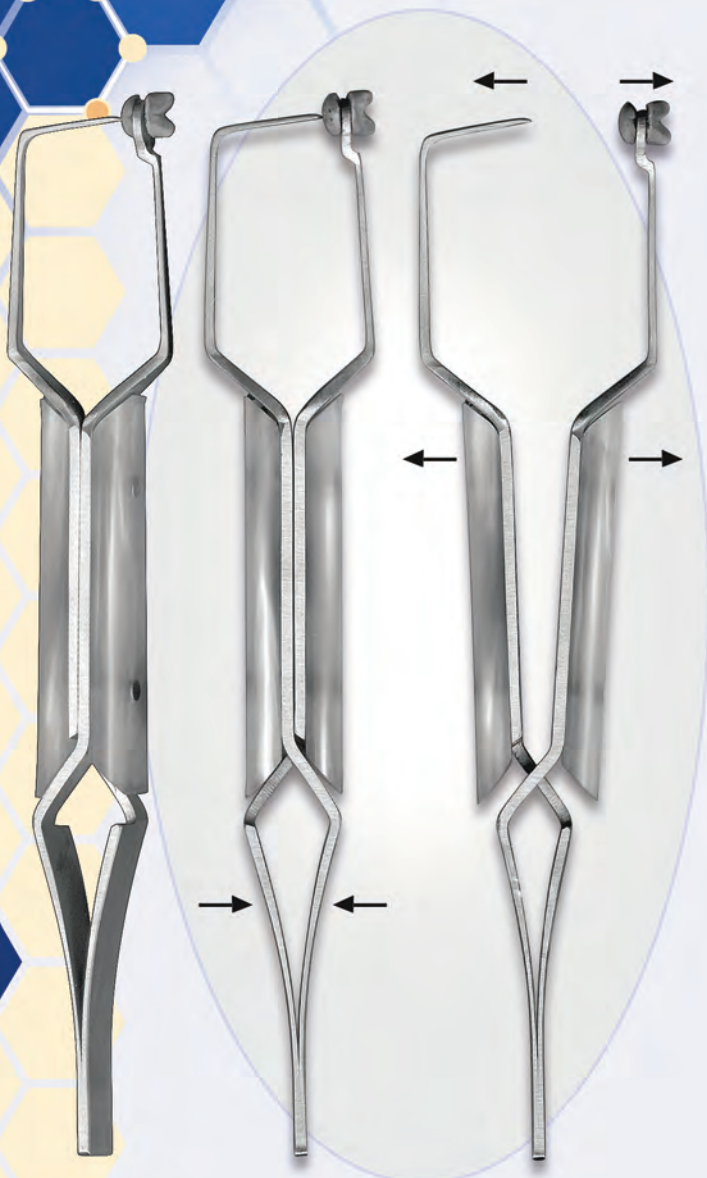

HSC 518-14
Smart Clip
Kraus
 135 mm

International patent pending. Patent No.: 10 2004 017 402.4

HSC 518-99
 Ersatzspitze
 Replacement tip

Spezial-Halteklammer

Die reziprok federnde Spezial-Halteklammer eignet sich optimal zum Bemalen, Glasieren und abschließenden Ätzen von Vollkeramikteilen wie Inlays, Teilkronen, Veneers, Seiten- und Frontzahnkronen.

Frontzahnkronen werden auf den Dorn gesteckt, so dass die Schneidekante in der Furche des Polsters gehalten wird. Die dadurch für den Pinsel nicht erreichbare Schneidekante kann problemlos nach dem Umsetzen auf den Brenntägern nachgemalt werden.

Alle anderen Keramikteile werden mit der Unterseite auf das Polster gelegt, wo sie durch den Dorn sicher gehalten werden. Dadurch ist die zu bemalende Oberseite für den Pinsel des Keramiklers frei zugänglich. Ein exakter, randgenauer Glasurauftrag ist dadurch leicht zu erzielen und durch Drehen im Licht gut zu kontrollieren.

Special holding clip

The special holding clip - reciprocally fitting with springs - is suitable optimally for painting, glazing and the final etching of full ceramic parts such as inlays, partial crowns, veneers, crowns for canines and incisors.

Incisors crowns are put on the mandrel, so that the cut edge is held in the furrow of the pad. The cut edge, not attainable thereby for the brush, can be worked at without problems on the fuel carriers after shifting the same.

All other ceramic parts are put on the pad with the bottom side, where they are kept safely by the mandrel. Thus the top side, which has to be worked at, is freely accessible for the brush of the ceramic worker. An accurate, edge-exact coating is hereby easily to obtain and can be controlled well by turning in light.



1
 Seitenansicht mit den zwei
 Einsatzmöglichkeiten des Polsters
 Side view with the two applications of the pad

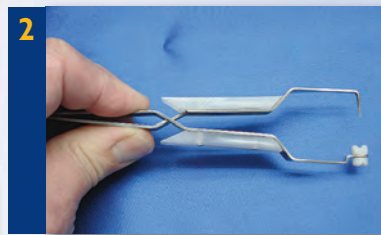

2
 Öffnen der Klemme durch Druck auf den
 hinteren Teil
 Opening of the clip by pressing the rear part

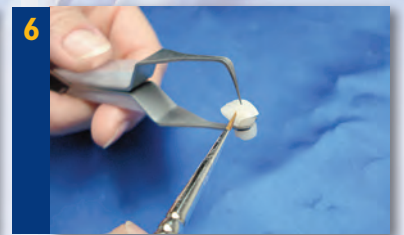

6
 Auch dünnste Veneers sind sicher fixierbar
 Even the thinnest veneers are safely fixed



3
 Einlegen des Objekts
 Inserting of the object

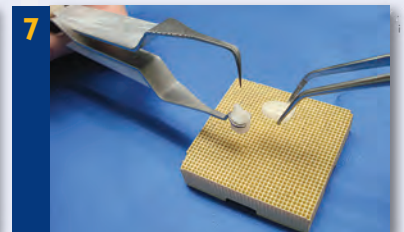

7
 Platzieren auf dem Brenntäger mithilfe
 einer Pinzette
 Placing on the firing tray using a forceps

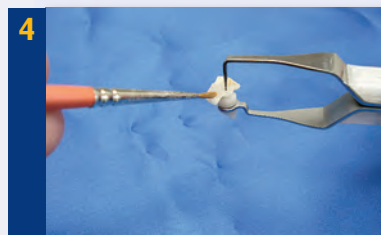

4
 Bemalen oder glasieren
 Painting or glazing



8
 Rationelles Beschichten mehrerer
 Objekte mit Ätzelgel
 Efficient coating of multiple objects
 with etching gel

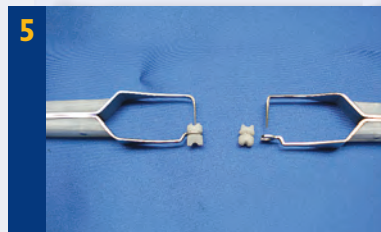

5
 Das Polster ist auswechselbar und rotierbar
 The pad is removable and rotatable



9
 Sicheres Abspülen und Abdampfen
 zum Reinigen
 Safe rinsing and evaporation for cleaning



HSL 550-99



1 Paar Ersatzsilikonplatten for
HSL 548-16 und HSL 549-16

1 pair of replacement silicone plates for
HSL 548-16 and HSL 549-16

HSL 548-16
160 mm

Pinzette für Zirkonarbeiten

- ✓ Zirkonkronenhalter / Zirkonkappchenhalter / Zirkongerüsthalter
- ✓ gerade
- ✓ Silikonplatten innen und außen anwendbar / individuell verstellbar
- ✓ plus 5 Paar Ersatzsilikonplatten

Forceps for Zirconium works

- ✓ Zirconium crown holder / Zirconium cap holder / Zirconium scaffold holder
- ✓ straight
- ✓ silicone plates for interior and exterior application / individually adjustable
- ✓ plus 5 pairs of replacement silicone plates

HSL 549-16
160 mm

Pinzette für Zirkonarbeiten

- ✓ Zirkonkronenhalter / Zirkonkappchenhalter / Zirkongerüsthalter
- ✓ gebogen
- ✓ Silikonplatten innen und außen anwendbar / individuell verstellbar
- ✓ plus 5 paar Ersatzsilikonplatten

Forceps for Zirconium works

- ✓ Zirconium crown holder / Zirconium cap holder / Zirconium scaffold holder
- ✓ curved
- ✓ silicone plates for interior and exterior application / individually adjustable
- ✓ plus 5 pairs of replacement silicone plates

Pinzetten Forceps

- ✓ Beschichtung: Flüssiggummi
- ✓ Coating: liquid rubber



HTC 090-11
110 mm

Titan-Präparierpinzette
einfache Ausführung

Titanium dissecting forceps
simple type



HSC 818-11
110 mm

Uhrmacherpinzette
einfache Ausführung

Forceps for watch-makers
simple type



HSC 524-16
Geppert
165 mm

Pinzette zum Greifen von Kleinstteilen
(z. B. kleine Schrauben) bzw. schlecht zu greifende Teile im Labor; hitzebeständig bis 130°C

Forceps for gripping smallest parts
(f. e. small screws) or parts bad to be gripped in the laboratory; heat resistant up to 130° C

HSC 525-30 ▶
Geppert
300 mm

Pinzette zum Abdampfen im Labor
hitzebeständig bis 130°C

Forceps for evaporating in the laboratory
heat resistant to 130° C





HSC 058-18
180 mm



HSC 530-30
300 mm

HSC 060-20
200 mm

Brenngutträgerpinzette
Spitze abgeflacht

HSC 062-25
250 mm

Fuel carrier pincers
Tip flattened

HSC 064-30
300 mm

Pinzetten
gerade
Forceps
straight

CE



HSC 528-16
160 mm



HSC 529-16
160 mm

Lötpinzetten mit isolierten Griffen
selbsthaltend

Soldering tweezers with insulated handles
self retaining

Solingen



HWN 300-22
220 mm
Ø 4,5 mm

HWN 301-25
250 mm
Ø 4,5 mm

HWN 302-32
320 mm
Ø 5,0 mm
Tiegelzange
aus Wironit Stahl

Crucible tongs
from Wironit steel

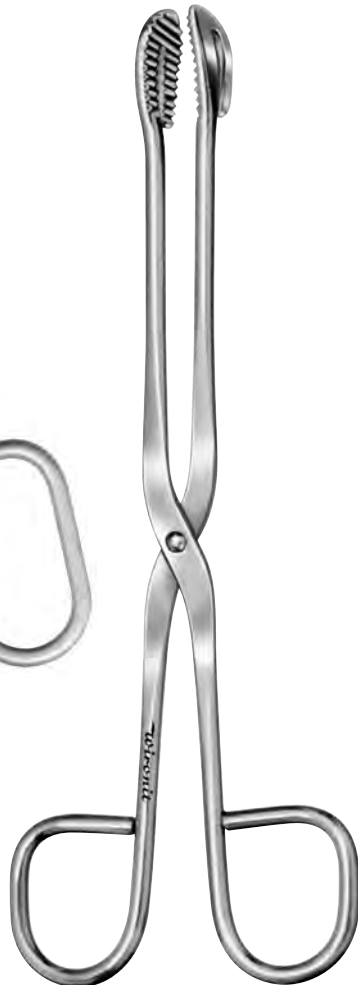

HWN 310-20
200 mm
Ø 4,5 mm

HWN 312-28
280 mm
Ø 4,5 mm
Universalhaltezeange
aus Wironit Stahl, gerade

Universal holding tongs
from Wironit steel, straight



HSN 338-55
550 mm
Ø 6 mm
Küvettenzange, rostfrei
Bulb-tongs, stainless



HSN 330-22
220 mm
Ø 4,5 mm

HSN 331-25
250 mm
Ø 5,0 mm

HSN 332-30
300 mm
Ø 5,0 mm

Tiegelzange, rostfrei

Crucible tongs, stainless



HSN 333-40
400 mm
Ø 6,0 mm

HSN 334-50
500 mm
Ø 7,0 mm

HSN 335-60
600 mm
Ø 8,0 mm



HWN 309-25
Hünebeck
255 mm
Universal-Haltezange
Universal holding tong

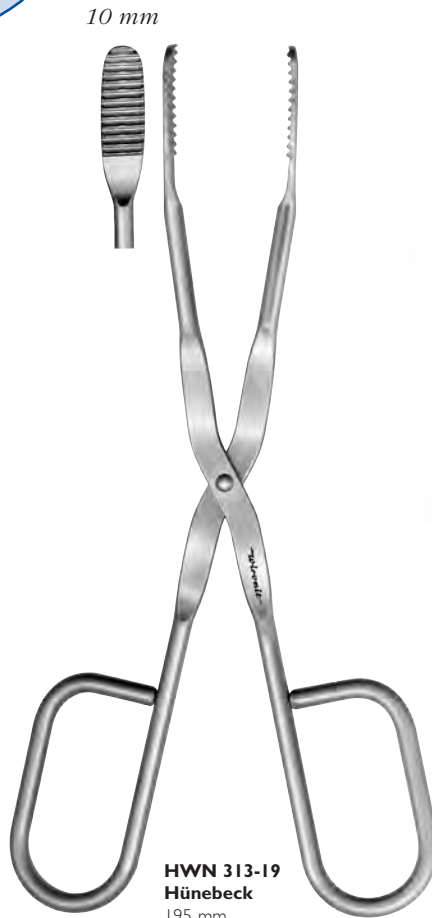

HWN 313-19
Hünebeck
195 mm
Universal-Haltezange
Universal holding tong



HWN 337-35
Hammacher
350 mm
Spezial-Muffelzange
Special crucible tongs



HWN 338-55
Hammacher
550 mm
Spezial-Muffelzange
Special crucible tongs



HSN 308-00
APT II
Brenner
Burner

HSN 308-99
 Butan-Gas, 500 ml Dose
 Butane gas, 500 ml box

HSN 308-00 APT II Brenner

- ✓ Ein Knopfdruck genügt und das spezielle Zündsystem des APT II sorgt für rasches Aufflammen - daher kein Frust mit Fehlzündungen mehr!
- ✓ Der APT II Brenner wird mit Batterie betrieben, ist daher ortsunabhängig und überall rasch einsatzbereit.
- ✓ Dank der Zündflammenregulierung beim APT II ist dieser Brenner vielseitig verwendbar, von der Gewebesterilisation bis zu Wachsarbeiten.
- ✓ Sichere Bedienung und kompakte Bauweise - das sind die Hauptmerkmale der besonderen Brennerkonstruktion beim APT II.
- ✓ Überall erhältliche Butangasbehälter, wie sie für das Aufladen von Feuerzeugen verwendet werden, genügen für mehrere Tausend Zündungen.

HSN 308-00 APT II Burner

- ✓ Unique APT II spark system ensures positive ignition with one push of the button. No frustration failure of ignition.
- ✓ The APT II is battery-powered, making it very portable. It can be used anywhere.
- ✓ The flame adjustment function of the APT II allows it to be used for a variety of purposes, from sterilization of cotton fabrics to wax work, etc.
- ✓ The APT II was designed with compactness and safety in mind.
- ✓ A standard butane container commonly available for use in refilling cigarette lighters provides enough fuel for thousands of ignitions.



HSN 311-01
 110 mm
 Ø 11 mm
 für Erdgas
 for naturel gas

HSN 312-02
 110 mm
 Ø 11 mm
 für Propangas
 for propane gas

Wipphebel-Brenner kurzes Modell, mit Sparflamme, vernickelt, für Gasdruck bis 500 mm Wassersäule

Double-lever-stopcock burners, short model, with pilot-flame, nickel-plated, for gas pressure up to 500 mm water gauge

Die perfekten Brenner mit Doppelhebelhahn.

- Mit einer Hand zu bedienen.
- Auch Feineinstellung der Flammenstärke möglich.
- ✓ Zum Einschalten der Flamme, das heißt zum Öffnen der Gaszufuhr, ist keine Aufwärtsbewegung mehr nötig, sondern man drückt einfach auf den anderen Hebelarm.

The ideal burners with double-leverstopcock.

- Can be manipulated with one hand.
- The more touch of a finger can regulate the flame.
- ✓ The size of the flame can be adjusted most accurately. Now the gas inlet tube is opened by simply pressing the red ball down or the green one down to close. This eliminates tilting of the burner what happened formerly.



**HSL 650-19
Hammacher**
190 mm
Hartgipsschneidezange
Hard plaster nipper

HSL 651-00
Verschluß, Feder, allein
Special lock, spring, only

HSL 653-00
Schraube, allein
Screw, only



HSL 654-19
190 mm
Hartgipsschneidezange, rostfrei
Hard plaster nipper; stainless

HSL 655-00
Federn, rostfrei, allein
Springs, stainless, only

Vorzüge Hammacher Hartgipsschneidezange:

- Unbeschwerliches und handliches Arbeiten durch Gewichtsersparnis
- Abrutschen der Hand in das Zangenmaul nicht möglich
- ✓ keine Klemmgefahr mehr
- ✓ bruchsichere farbige Kunststoffgriffe
- ✓ rostsicherer Edelstahl
- ✓ diese Zange kann leicht mit einer Hand geöffnet und geschlossen werden
- ✓ bequemes Arbeiten durch veränderte Schenkelstellung

Advantages Hammacher hard plaster nipper:

- Easy, handy working thanks to less weight
- ✓ it is impossible for the hand to slip down into the bit of the forceps
- ✓ no more danger of getting caught
- ✓ unbreakable, coloured plastic handles
- ✓ non-rusting stainless steel
- ✓ these forceps can easily be opened and closed with one hand
- ✓ comfortable working thanks to altered position of the shanks



Wironit Instrumente sind aus einer Speziallegierung gefertigt und weisen folgende Vorteile auf:

- ✓ nichtrostend
- ✓ antimagnetisch
- ✓ säurebeständig

Sie sind formschön, liegen leicht in der Hand und sind von langer Lebensdauer.



Wironit instruments are made of a special alloy and show the following advantages:

- ✓ rust resistant
- ✓ anti-magnetic
- ✓ acid resistant

They are beautifully designed and of unlimited durability.



Gipsmesser, aus Wironit Stahl
Plaster knives, from Wironit steel

- das handliche Gipsmesser von HAMMACHER -
- the handy plaster knife from HAMMACHER -



HSL 121-18
180 mm



HSL 122-16
Gritman
165 mm



HSL 123-16
Hammacher
160 mm



HSL 123-18
Hammacher
180 mm



Gips
Solingen

Gipsmesser, aus rostfreiem Stahl
Plaster knives, from stainless steel

Zeichenerklärung
Explication of abbreviations

SB = Spatelbreite
 SB = Width of spatula

SL = Spatel-Länge
 SL = Length of spatula

L = Gesamtlänge
 L = Length overall



HWN 250-18
 L = 180 mm
 SB = 18 mm
 SL = 90 mm



HWN 260-15
 L = 155 mm
 SB = 8 mm
 SL = 55 mm



HWN 265-15
 L = 150 mm
 SB = 10 mm
 SL = 55 mm



HWN 270-21
 L = 215 mm
 SB = 21 mm



HWN 271-21
 L = 210 mm
 SB = 30 mm
 SL = 115 mm



HSL 129-13
 Gipsbecher aus Weichgummi
 Mixing bowl of soft rubber

HWN 251-20
 L = 200 mm
 SB = 18 mm
 SL = 110 mm

HWN 261-15
 L = 155 mm
 SB = 10 mm
 SL = 55 mm

HWN 252-22
 L = 220 mm
 SB = 18 mm
 SL = 125 mm

aus Wironit Stahl
 from Wironit steel



HWN 272-22
220 mm
aus Wironit Stahl
from Wironit steel



HWN 273-21
Ash 8x
215 mm
aus Wironit Stahl
from Wironit steel



HSN 290-19
195 mm
doppelendig und leicht
entgegengesetzt gebogen
double-ended, slightly
inversed curved



HSN 291-17
170 mm
gerade
straight



HSN 292-19
190 mm
aus Kunststoff
from plastic

Zeichenerklärung
Explication of abbreviations

SB = Spatelbreite
 SB = Width of spatula

SL = Spatel-Länge
 SL = Length of spatula

L = Gesamtlänge
 L = Length overall



HSN 200-08
 flexibel
 L = 160 mm
 SL = 80 mm

HSN 203-16
 flexibel
 L = 255 mm
 SL = 160 mm

HSN 201-10
 flexibel
 L = 190 mm
 SL = 105 mm

HSN 204-18
 flexibel
 L = 285 mm
 SL = 180 mm

HSN 202-13
 flexibel
 L = 220 mm
 SL = 130 mm

HSN 205-21
 flexibel
 L = 310 mm
 SL = 210 mm

_____ *federnd* _____
 _____ *elastic* _____



HSN 210-07
 L = 165 mm
 SL = 75 mm
 SB = 14 mm

HSN 211-10
 L = 190 mm
 SL = 100 mm
 SB = 18 mm

HSN 212-13
 L = 230 mm
 SL = 130 mm
 SB = 20 mm

HSN 213-15
 L = 250 mm
 SL = 150 mm
 SB = 22 mm

Spatel mit Holzgriff und rostfreier, gehärteter Klinge
Spatula with wooden handle and a stainless, hardened blade



HSN 214-20
 L = 310 mm
 SL = 200 mm
 SB = 32 mm

HSN 215-25
 L = 265 mm
 SL = 250 mm
 SB = 38 mm

HSN 216-30
 L = 415 mm
 SL = 300 mm
 L = 42 mm

HSN 220-08
 L = a180 mm
 SL = 80 mm

HSN 221-10
 L = 205 mm
 SL = 105 mm

HSN 222-13
 L = 230 mm
 SL = 130 mm
Spatel-Messer, flexibel
Spatula-knive, flexible

Solingen

Zeichenerklärung
Explication of abbreviations

SB = Spatelbreite
 SB = Width of spatula

SL = Spatel-Länge
 SL = Length of spatula

L = Gesamtlänge
 L = Length overall



HSN 218-13

L = 230 mm
 SL = 130 mm
 SB = 20 mm

Apothekerspatel

Klinge federharter CrNi-Stahl, dünn geschliffen

Chemist's spatula

blade CrNi steel, ground fine



HSN 225-08

L = 180 mm
 SL = 80 mm

HSN 226-10

L = 205 mm
 SL = 105 mm

HSN 227-13

L = 230 mm
 SL = 130 mm



HSN 230-08

L = 180 mm
 SL = 80 mm

HSN 231-10

L = 205 mm
 SL = 105 mm

HSN 232-13

L = 230 mm
 SL = 130 mm



HSN 235-08

L = 180 mm
 SL = 80 mm

HSN 236-10

L = 205 mm
 SL = 105 mm

HSN 237-13

L = 230 mm
 SL = 130 mm



Spatel-Messer, flexibel

Spatula-knive, flexible



Solingen



HSB 704-10
fig. 10
unsteril
not sterile



HSB 705-11
fig. 11
unsteril
not sterile



HSB 707-15
fig. 15
unsteril
not sterile

Skalpellsklingen, in Packungen zu 100 Stück,
Scalpel blades, in packages of 100 pieces



HSB 743-00
für HSB 742-00
for HSB 742-00



HSB 747-01
für HSB 746-00
for HSB 746-00



HSB 748-02
für HSB 746-00
for HSB 746-00



HSB 751-01
für HSB 750-00
for HSB 750-00



HSB 752-02
für HSB 750-00
for HSB 750-00



HSB 756-06
für HSB 750-00
for HSB 750-00

Ersatzklingen - Verpackungseinheit: 10 Stück, unsteril
Spare blades - packagunit of 10 pieces, not sterile



HSB 805-03
Standard
Skalpellsgriff
für Klingen HSB 704-10 bis HSB 707-15
Scalpel handle
for blades HSB 704-10 to HSB 707-15

CE



HSB 742-00
120 mm
Griff für Folienmesser
HSB 743-00
Handle of foil knife
HSB 743-00



HSB 746-00
130 mm
Griff für Folienmesser
HSB 747-01 und **HSB 748-02**
Handle of foil knife
HSB 747-01 und **HSB 748-02**



HSB 750-00
Messersgriff
für Klingen **HSB 751-01** bis **HSB 756-06**
Knife-handle
for blades **HSB 751-01** to **HSB 756-06**



HSL 670-12
0,12 x 5 mm



HSL 671-25
0,25 x 5 mm



HSL 672-15
0,25 x 3 mm



HSL 673-12
0,12 x 2,8 mm

Modellsägeblätter; schnellschneidend und biegefest
 Saw blades, quick cutting with high flexural strength

Verpackungseinheit: 24 Stück
 Standard package: 24 pcs



HSL 668-20
200 mm
Modellsäge
Model saw



HSL 669-18
180 mm
Abgewinkelte Säge
Bowed model saw



HSL 676-00
Laubsägebögen, verstellbar;
mit Holzgriff, mit Spannschraube
Fret saw frames, adjustable,
with wooden handle, with tension screw

Laubsägeblätter
Fret saw blades



HSL 678-00
fig. 0

HSL 684-01
fig. 1

HSL 679-01
fig. 1

HSL 685-02
fig. 2

HSL 680-02
fig. 2

HSL 686-03
fig. 3

HSL 681-03
fig. 3
für Metall
for metal

für Gips
for plaster



HSL 660-21
210 mm
Niethammer mit Holzgriff,
spitz, Normalstahl
Riveting hammer
with wooden handle,
pointed, normal steel



HSB 582-12
 120 mm
 Laborschere
 Laboratory scissors



HSB 586-18
 180 mm
 Laborschere
 Laboratory scissors



HSB 588-20
 200 mm
 Laborschere
 Laboratory scissors



HSB 596-20
 200 mm
 Laborschere
 rostfrei
 Laboratory scissors
 stainless



HSB 598-18
 180 mm
 Laborschere, verchromt
 Laboratory scissors,
 chromium plated



HSB 602-14
 145 mm
 Verbandschere
 Bandage scissors



HSB 624-16
 160 mm
 Laborschere, vernickelt
 Laboratory scissors, nickel plated



HSB 636-25
 250 mm
 Papierschere, vernickelt
 Paper scissors, nickel plated



SGCI 050-00
20 cm
Küchenschere
Kitchen scissors



SGCI 051-20
20 cm
Haushaltsschere
Household scissors



SGCI 052-15
15 cm
Haushaltsschere
Household scissors

COMFORT line

Messer

- ✓ Hochwertiger Chrom-Molybdän Stahl X 50 CrMoV 15
- ✓ aus einem Stück geschmiedet
- ✓ spezial öl- und eisgehärtet
- ✓ Handabzug
- ✓ handsympatischer Griff
- ✓ nahtloser Übergang von Klinge zu Griff
- ✓ spülmaschinenfest
- ✓ höchste Rostsicherheit
- ✓ modernes Design

COMFORT line

knives

- ✓ high quality Chrome-Molybdenum steel X 50 CrMoV 15
- ✓ forged from one part
- ✓ specially oil- and ice-hardened
- ✓ hand honed
- ✓ handy handle
- ✓ seamless pass-over between blade and handle
- ✓ dishwasher-safe
- ✓ highest stainless
- ✓ modern design



COMFORT line

SGCI 109-00

Messerblock mit 6 Teilen, Natur

Inhalt: Spickmesser 9 cm
Schinkenmesser 15 cm
Ausbeinmesser 15 cm
Brotmesser 23 cm
Kochmesser 20 cm
Wetzstahl 26 cm

Knife block set 6 pcs., natural

Contents: Paring knife 9 cm
Ham slicer 15 cm
Boning knife 15 cm
Bread knife 23 cm
Chef's knife 20 cm
Sharpening steel 26 cm

SGCI 100-09

9 cm
Gemüsemesser
Paring knife



SGCI 101-09

9 cm
Officemesser
Fluting knife



SGCI 102-13

13 cm
Tomatenmesser
Tomato knife



SGCI 103-15

15 cm
Schinkenmesser
Ham slicer

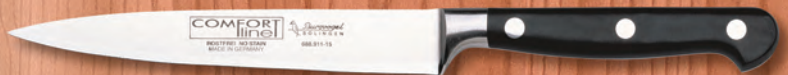

SGCI 104-20

20 cm
Schinkenmesser
Ham slicer



SGCI 105-23

23 cm
Brotmesser
Bread knife



SGCI 106-15

15 cm
Kochmesser
Chef's knife



SGCI 107-20

20 cm
Kochmesser
Chef's knife





SGCI 115-00

Messerblock mit 7 Teilen, Natur

Inhalt: Spickmesser 9 cm
Schinkenmesser 20 cm
Fleischgabel 15 cm
Brotmesser 23 cm
Kochmesser 20 cm
Wetzstahl 26 cm
Allzweckschere

Knife block set 7 pcs., natural

Contents: Paring knife 9 cm
Ham slicer 20 cm
Meat fork 15 cm
Bread knife 23 cm
Chef's knife 20 cm
Sharpening steel 26 cm
Universal scissors

COMFORT
line



SGCI 110-12

12 cm
Buntschneidmesser
Decorating knife



SGCI 111-14

14 cm
Käsemesser
Cheese knife



SGCI 113-15

14 cm
Ausbeinmesser; flexibel
Boning knife, flexible



SGCI 114-18

18 cm
Filiermesser; flexibel
Filleting knife, flexible



SGCI 112-31

31 cm
Lachsmesser
Salmon knife

COMFORT line Messer

- ✓ Hochwertiger Chrom-Molybdän Stahl X 50 CrMoV 15
- ✓ aus einem Stück geschmiedet
- ✓ spezial öl- und eisgehärtet
- ✓ Handabzug
- ✓ handsympatischer Griff
- ✓ nahtloser Übergang von Klinge zu Griff
- ✓ spülmaschinenfest
- ✓ höchste Rostsicherheit
- ✓ modernes Design

COMFORT line knives

- ✓ high quality Chrome-Molybdenum steel X 50 CrMoV 15
- ✓ forged from one part
- ✓ specially oil- and ice-hardened
- ✓ hand honed
- ✓ handy handle
- ✓ seamless pass-over between blade and handle
- ✓ dishwasher-safe
- ✓ highest stainless
- ✓ modern design



SGCI 108-00
Kochbesteck
Cooking set



SGCI 116-06
Steakmessersatz 6tlg.
Steak knife set 6 pcs.



COMFORT line



SGCI 117-10
10 cm
Kochmesser
Chef's knife



SGCI 118-18
18 cm
Japankochmesser mit Kulle
Japanese chef's knife with grooved edge



SGCI 119-13
13 cm
Kräutermesser
Knife for herbs



SGCI 130-09
9 cm
Gemüsemesser
Paring knife



SGCI 131-13
13 cm
Brötchenmesser
Bread knife



SGCI 132-14
14 cm
Käsemesser
Cheese knife



SGCI 133-13
13 cm
Tomatenmesser
Tomato knife



SGCI 134-13
13 cm
Kräutermesser
Herb knife



SGCI 135-15
15 cm
Ausbeinmesser; flexibel
Boning knife, flexible



SGCI 136-18
18 cm
Fillermesser; flexibel
Filleting knife, flexible



SGCI 137-31
31 cm
Lachsmesser
Salmon knife

NATURA Line Messer

- ✓ Hochwertiger Chrom-Molybdän Stahl X 50 CrMoV 15
- ✓ aus einem Stück geschmiedet
- ✓ spezial öl- und eisgehärtet
- ✓ Handabzug
- ✓ handsympatischer Griff
- ✓ nahtloser Übergang von Klinge zu Griff
- ✓ elegante Griffe aus Satine Rotholz
- ✓ höchste Rostsicherheit
- ✓ modernes Design

NATURA Line knives

- ✓ high quality Chrome-Molybdenum steel X 50 CrMoV 15
- ✓ forged from one part
- ✓ specially oil- and ice-hardened
- ✓ hand honed
- ✓ handy handle
- ✓ seamless pass-over between blade and handle
- ✓ elegant handles made from Satine redwood
- ✓ highest stainless
- ✓ modern design

NATURA Line Messer

- ✓ Hochwertiger Chrom-Molybdän Stahl X 50 CrMoV 15
- ✓ aus einem Stück geschmiedet
- ✓ spezial öl- und eisgehärtet
- ✓ Handabzug
- ✓ handsympatischer Griff
- ✓ nahtloser Übergang von Klinge zu Griff
- ✓ elegante Griffe aus Satine Rotholz
- ✓ höchste Rostsicherheit
- ✓ modernes Design

NATURA Line knives

- ✓ high quality Chrome-Molybdenum steel X 50 CrMoV 15
- ✓ forged from one part
- ✓ specially oil- and ice-hardened
- ✓ hand honed
- ✓ handy handle
- ✓ seamless pass-over between blade and handle
- ✓ elegant handles made from Satine redwood
- ✓ highest stainless
- ✓ modern design



SGCI 138-15
15 cm
Schinkenmesser
Ham slicer

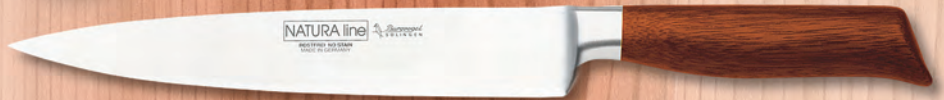

SGCI 139-18
18 cm
Schinkenmesser
Ham slicer



SGCI 140-23
23 cm
Brotmesser
Bread knife



SGCI 141-15
15 cm
Kochmesser
Chef's knife



SGCI 142-20
20 cm
Kochmesser
Chef's knife



SGCI 143-15
15 cm
Fleischgabel
Meat fork



SGCI 144-26
26 cm
Wetzstahl
Sharpening steel



SGCI 338-00

TOOL TEC

Zange mit Drahtschneider; Feile, Säge, Schlitz- und Kreuzschlitzschraubendreher; Glasbrecher; Bitadapter mit 9 Bits, Kapselheber, Dosenöffner, Klinge und Gürteltasche

Pliers with wire cutter; file, saw, flat tip and cross tip screwdrivers, glass breaker, bit adapter with 9 bits, cap lifter, can opener, blade and belt pouch



SGCI 330-07

STRUKTURA classic maxi 7

Taschenmesser mit großer und kleiner Klinge, Dosenöffner; Kombination aus Kapselheber und Schraubendreher; Korkenzieher; Lederbohrer; Schere, Ring, Pinzette, Zahnstocher

Pocket knife with large and small blade, can opener; cap lifter and screwdriver combination, corkscrew, piercer, scissors, key ring, tweezers, toothpick



SGCI 340-05

WAVE manicure

Maniküre Etui mit Nagelschere aus rostfreiem Edelstahl, Nagelknipser, Nagelfeile mit Nagelreiniger, Pinzette, Nagelhautmesser- und schieber

Manicure set with nail scissors made of stainless steel, nail clippers, nail file with nail cleaner, tweezers, cuticle knife and cuticle pusher

SGCI 335-03

STRUKTURA roma 3

Maniküre Etui aus Leder und rostfreiem Edelstahl mit Nagelschere, Pinzette und Saphir-Nagelfeile mit Nagelreiniger

Manicure case made of leather and stainless steel with nail scissors, tweezers, sapphire nail file with nail cleaner





HSM 150-00

Maniküre-Etui 5-teilig, Nappaleder, schwarz
Manicure case with 5 parts, Nappa leather; black

HSM 150-06

Maniküre-Etui 5-teilig
Manicure case with 5 parts



HSM 140-13
130 mm
Saphirnagelfeile
Sapphire nail file



HSM 139-12
125 mm
Nagelreiniger
Nail cleaner



HSB 652-09
95 mm
Nagelschere
Nail scissors



HSB 391-10
Hammacher
105 mm
Schere, gebogen
Scissors, curved



HSM 145-01
90 mm
Kombinierte Haar- und Splitterpinzette
Combined hair and splinter forceps

Schlüsselanhänger
Key chain



HWL 390-00

Abdrucklöffel
Impression tray



HSA 590-00

Zahnzange
Extracting forceps

По вопросам продаж и поддержки обращайтесь:

Алматы (727)345-47-04
Ангарск (3955)60-70-56
Архангельск (8182)63-90-72
Астрахань (8512)99-46-04
Барнаул (3852)73-04-60
Белгород (4722)40-23-64
Благовещенск (4162)22-76-07
Брянск (4832)59-03-52
Владивосток (423)249-28-31
Владикавказ (8672)28-90-48
Владимир (4922)49-43-18
Волгоград (844)278-03-48
Вологда (8172)26-41-59
Воронеж (473)204-51-73
Екатеринбург (343)384-55-89

Иваново (4932)77-34-06
Ижевск (3412)26-03-58
Иркутск (395)279-98-46
Казань (843)206-01-48
Калининград (4012)72-03-81
Калуга (4842)92-23-67
Кемерово (3842)65-04-62
Киров (8332)68-02-04
Коломна (4966)23-41-49
Кострома (4942)77-07-48
Краснодар (861)203-40-90
Красноярск (391)204-63-61
Курск (4712)77-13-04
Курган (3522)50-90-47
Липецк (4742)52-20-81

Магнитогорск (3519)55-03-13
Москва (495)268-04-70
Мурманск (8152)59-64-93
Набережные Челны (8552)20-53-41
Нижний Новгород (831)429-08-12
Новокузнецк (3843)20-46-81
Ноябрьск (3496)41-32-12
Новосибирск (383)227-86-73
Омск (3812)21-46-40
Орел (4862)44-53-42
Оренбург (3532)37-68-04
Пенза (8412)22-31-16
Петрозаводск (8142)55-98-37
Псков (8112)59-10-37
Пермь (342)205-81-47

Ростов-на-Дону (863)308-18-15
Рязань (4912)46-61-64
Самара (846)206-03-16
Санкт-Петербург (812)309-46-40
Саратов (845)249-38-78
Севастополь (8692)22-31-93
Саранск (8342)22-96-24
Симферополь (3652)67-13-56
Смоленск (4812)29-41-54
Сочи (862)225-72-31
Ставрополь (8652)20-65-13
Сургут (3462)77-98-35
Сыктывкар (8212)25-95-17
Тамбов (4752)50-40-97
Тверь (4822)63-31-35

Тольятти (8482)63-91-07
Томск (3822)98-41-53
Тула (4872)33-79-87
Тюмень (3452)66-21-18
Ульяновск (8422)24-23-59
Улан-Удэ (3012)59-97-51
Уфа (347)229-48-12
Хабаровск (4212)92-98-04
Чебоксары (8352)28-53-07
Челябинск (351)202-03-61
Череповец (8202)49-02-64
Чита (3022)38-34-83
Якутск (4112)23-90-97
Ярославль (4852)69-52-93

Россия +7(495)268-04-70

Казахстан +7(727)345-47-04

Беларусь +(375)257-127-884

Узбекистан +998(71)205-18-59

Киргизия +996(312)96-26-47

эл.почта: hqs@nt-rt.ru || сайт: <https://hammacher.nt-rt.ru/>