

# Каталог лабораторных продуктов Hammacher

По вопросам продаж и поддержки обращайтесь:

Алматы (727)345-47-04  
Ангарск (3955)60-70-56  
Архангельск (8182)63-90-72  
Астрахань (8512)99-46-04  
Барнаул (3852)73-04-60  
Белгород (4722)40-23-64  
Благовещенск (4162)22-76-07  
Брянск (4832)59-03-52  
Владивосток (423)249-28-31  
Владикавказ (8672)28-90-48  
Владимир (4922)49-43-18  
Волгоград (844)278-03-48  
Вологда (8172)26-41-59  
Воронеж (473)204-51-73  
Екатеринбург (343)384-55-89

Иваново (4932)77-34-06  
Ижевск (3412)26-03-58  
Иркутск (395)279-98-46  
Казань (843)206-01-48  
Калининград (4012)72-03-81  
Калуга (4842)92-23-67  
Кемерово (3842)65-04-62  
Киров (8332)68-02-04  
Коломна (4966)23-41-49  
Кострома (4942)77-07-48  
Краснодар (861)203-40-90  
Красноярск (391)204-63-61  
Курск (4712)77-13-04  
Курган (3522)50-90-47  
Липецк (4742)52-20-81

Магнитогорск (3519)55-03-13  
Москва (495)268-04-70  
Мурманск (8152)59-64-93  
Набережные Челны (8552)20-53-41  
Нижний Новгород (831)429-08-12  
Новокузнецк (3843)20-46-81  
Ноябрьск (3496)41-32-12  
Новосибирск (383)227-86-73  
Омск (3812)21-46-40  
Орел (4862)44-53-42  
Оренбург (3532)37-68-04  
Пенза (8412)22-31-16  
Петрозаводск (8142)55-98-37  
Псков (8112)59-10-37  
Пермь (342)205-81-47

Ростов-на-Дону (863)308-18-15  
Рязань (4912)46-61-64  
Самара (846)206-03-16  
Санкт-Петербург (812)309-46-40  
Саратов (845)249-38-78  
Севастополь (8692)22-31-93  
Саранск (8342)22-96-24  
Симферополь (3652)67-13-56  
Смоленск (4812)29-41-54  
Сочи (862)225-72-31  
Ставрополь (8652)20-65-13  
Сургут (3462)77-98-35  
Сыктывкар (8212)25-95-17  
Тамбов (4752)50-40-97  
Тверь (4822)63-31-35

Тольятти (8482)63-91-07  
Томск (3822)98-41-53  
Тула (4872)33-79-87  
Тюмень (3452)66-21-18  
Ульяновск (8422)24-23-59  
Улан-Удэ (3012)59-97-51  
Уфа (347)229-48-12  
Хабаровск (4212)92-98-04  
Чебоксары (8352)28-53-07  
Челябинск (351)202-03-61  
Череповец (8202)49-02-64  
Чита (3022)38-34-83  
Якутск (4112)23-90-97  
Ярославль (4852)69-52-93

Россия +7(495)268-04-70

Казахстан +7(727)345-47-04

Беларусь +(375)257-127-884

Узбекистан +998(71)205-18-59

Киргизия +996(312)96-26-47

эл.почта: [hqs@nt-rt.ru](mailto:hqs@nt-rt.ru) || сайт: <https://hammacher.nt-rt.ru/>



<b>Tiegelzangen / Crucible tongs</b>	<b>1</b>	<b>1</b>
<b>Spatel / Spatulas</b>	<b>5</b>	<b>2</b>
<b>Löffel / Spoons</b>	<b>23</b>	<b>3</b>
<b>Scheren / Scissors</b>	<b>29</b>	<b>4</b>
<b>Pinzetten / Forceps</b>	<b>48</b>	<b>5</b>
<b>Sonden und Nadeln / Probes and Needles</b>	<b>68</b>	<b>6</b>
<b>Klemmen / Clamps</b>	<b>75</b>	<b>7</b>
<b>Skalpelle und Messer / Scalpels and Knives</b>	<b>81</b>	<b>8</b>
<b>Bestecke / Sets</b>	<b>89</b>	<b>9</b>
<b>Verschiedenes / Miscellaneous</b>	<b>98</b>	<b>10</b>



# Hammacher Instrumente

## Wir über uns

1922 gegründet verfügt die Karl Hammacher GmbH über fast 100 Jahre Erfahrung und Tradition

## About us

Founded in 1922 Karl Hammacher GmbH disposes of nearly 100 years of experience and tradition



## STAINLESS STEEL

**Instrumente aus rostfreiem Stahl** sind rostsicher jedoch nicht rostfrei wie die Wironit Instrumente. Instrumente aus rostfreiem Stahl erkennt man am **S** in der Artikelnummer (z.B. **HSB** 002-09).

**Instruments made of stainless steel** are rust proof but not rust-free like the Wironit instruments. Instruments made of stainless steel can be identified by the **S** in the article number (e.g. **HSB** 002-09).



## TITANIUM

**Titan Instrumente** sind 40 % leichter als Instrumente aus rostfreiem Stahl – sie sind absolut rostsicher und geeignet für alle gängigen Reinigungs- und Sterilisationsarten.

Instrumente aus Titan erkennt man am **T** in der Artikelnummer (z.B. **HTC** 033-05).

**Titanium instruments** are 40% lighter than instruments made of stainless steel - they are absolutely rust-proof and suitable for all common types of cleaning and sterilization.

Instruments made of Titanium can be identified by the **T** in the article number (e.g. **HTC** 033-05).



## WIRONIT

## *wironit*

**Wironit Instrumente** sind aus einer Speziallegierung gefertigt und weisen folgende Vorteile auf:

- ✓ nichtrostend
- ✓ antimagnetisch
- ✓ säurebeständig

Sie sind formschön, liegen leicht in der Hand und sind von langer Lebensdauer.

Instrumente aus WIRONIT erkennt man am **W** in der Artikelnummer (z.B. **HWN** 001-02).

**Wironit instruments** are made of a special alloy and show the following advantages:

- ✓ rust resistant
- ✓ anti-magnetic
- ✓ acid resistant

They are beautifully designed and of unlimited durability.

Instruments made of WIRONIT can be identified by the **W** in the article number (e.g. **HWN** 001-02).

# Instrumentenpflege

Für die Herstellung unserer Instrumente verwenden unsere qualifizierten Chirurghiemechaniker hochwertige Edelstähle, die sorgfältig be- und verarbeitet werden. Dennoch ist eine sorgfältige Pflege der Instrumente überaus wichtig.

## Pflege Tipps

- Vor dem ersten Gebrauch müssen die Instrumente gereinigt, getrocknet und sterilisiert werden.
- Das Instrumentarium sollte auf schonende Weise gehandhabt werden.
- Die Instrumente sollten nach Gebrauch gereinigt werden.
- Es ist auf die richtige Eignung und Dosierung der Reinigungs- bzw. Desinfektionsmittel zu achten.
- Instrumente mit Gelenken sollten in geöffnetem Zustand gereinigt bzw. desinfiziert werden.
- Die schonendste Behandlung ist die Reinigung per Hand – dabei sollten weder Metallbürsten noch Scheuermittel verwendet werden.
- Feine und empfindliche Instrumente – auch Mundspiegel – sollten nur von Hand gereinigt werden.
- Bei einer maschinellen Reinigung muss unbedingt auf eine sichere Verankerung der Instrumente und die Einhaltung der Gebrauchsanweisung der Gerätehersteller geachtet werden.
- Rostfrei Instrumente sind unbedingt getrennt von nicht rostfreien, alten, beschädigten, vernickelten und verchromten Instrumenten zu reinigen, da sonst die Gefahr von Flugpost besteht.
- Bei scharfen Reinigungsmitteln (z.B. Zemententferner) muss auf die genaue Dosierung und Einwirkzeit geachtet werden, da sonst – insbesondere bei der Ultraschallreinigung – die Instrumente sehr stark angeheizt werden.
- Nach jedem Reinigungsvorgang müssen die Instrumente mehrmals gründlich mit destilliertem oder vollentsalztem Wasser abgespült, danach getrocknet sowie auf Sauberkeit und Funktion geprüft werden.
- Nasse Instrumente dürfen nicht in den Autoklaven oder den Heißluftsterilisator gegeben werden.
- Bei chemischen Produkten und Geräten ist genau auf die Herstellerhinweise zu achten.

**Diese Tipps werden Ihr hochwertiges Instrumentarium lange Zeit erhalten !!**

# Maintenance of instruments

For the manufacturing of our instruments our high qualified surgical mechanics use high quality stainless steels which will be carefully worked at. Nevertheless a conscientious maintenance of the instruments is particularly important.

## Maintenance tips

- Prior to the first use the instruments should be cleaned, dried and sterilized.
- The instruments should be handled with care.
- After use the instruments should be cleaned.
- The correct suitability and dosage of the detergent or disinfectant solutions must be considered.
- Instruments with joints have to be opened before cleaning and disinfection.
- The most careful treatment is the manual cleaning – do not use wire brushes or abrasive cleaners.
- Delicate instruments – also mouth mirrors – should be cleaned by hand
- When using ultrasonic machines or thermodisinfectors it is imperative to ensure a secure anchoring of the instruments and compliance with the instructions for use of the equipment manufacturers.
- Do not mix up stainless, carbon steel, old, damaged, nickel or chrome plated instruments for cleaning as this may cause corrosion.
- In the case of strong cleaning agents (f. e. cement remover) the exact dosage and exposure time must be taken into consideration, as otherwise the instruments are heated very strongly – especially during ultrasonic cleaning.
- After each cleaning process the instruments have to be rinsed thoroughly with distilled or deionized water, then dried and checked for cleanliness and function.
- Wet instruments must not be placed in the autoclave or hot-air sterilizer.
- For chemical products and devices the manufacturer's instructions have to be observed.

**These tips will help you to keep your high quality instrument for a long time !!**



**H***wironit*aus Wironit Stahl  
from Wironit steel**Tiegel- und Haltezangen**  
Crucible and holding tongs**Tiegelzangen**  
Crucible tongs**1**

35 mm



10 mm

**HWN 300-22**  
220 mm  
Ø 4,5 mm**HWN 301-25**  
250 mm  
Ø 4,5 mm**HWN 302-32**  
320 mm  
Ø 5,0 mm  
Tiegelzangen, aus Wironit Stahl  
Crucible tongs, from Wironit steel**HWN 309-25**  
Hünebeck  
255 mm  
Universal-Haltezange  
Universal holding tong**HWN 313-19**  
Hünebeck  
195 mm  
Universal-Haltezange  
Universal holding tong**HWN 310-20**  
200 mm  
Ø 4,5 mm**HWN 312-28**  
280 mm  
Ø 4,5 mm  
Universalhalte zangen, aus Wironit Stahl, gerade  
Universal holding tongs, from Wironit steel, straight**H***wironit***Wironit Instrumente sind aus einer Speziallegierung gefertigt und weisen folgende Vorteile auf:**

- ✔ nichtrostend
- ✔ antimagnetisch
- ✔ säurebeständig

Sie sind formschön, liegen leicht in der Hand und sind von langer Lebensdauer.

**H***wironit***Wironit instruments are made of a special alloy and show the following advantages:**

- ✔ rust resistant
- ✔ anti-magnetic
- ✔ acid resistant

They are beautifully designed and of unlimited durability.

**1**

1

# Tiegelzangen Crucible tongs

Diverse Haltezangen  
Various holding tongs

H

Wironit

aus Wironit Stahl  
from Wironit steel

75 mm  
Ø 13 mm



**HWN 322-13**  
135 mm  
Reagenzglashalter  
Test tube holder



**HSN 391-20**  
Tiegelzange, teflonbeschichtet, 200 mm  
Crucible tongs, Teflon coated, 200 mm

**HSN 392-25**  
Tiegelzange, teflonbeschichtet, 250 mm  
Crucible tongs, Teflon coated, 250 mm

**HSN 393-30**  
Tiegelzange, teflonbeschichtet, 300 mm  
Crucible tongs, Teflon coated, 300 mm



**HWN 331-28**  
280 mm  
Spezialfaßzange für Bleitöpfchen,  
Winkellänge 70 mm  
Special grasping forceps for little lead pots,  
length of angle 70 mm

2

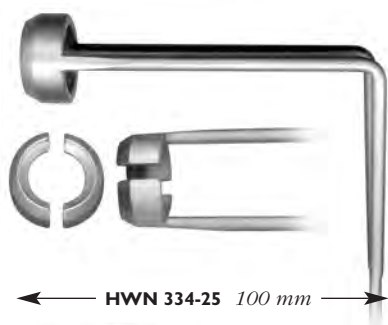
**H***wironit*aus Wironit Stahl  
from Wironit steelHaltezange und Spezial-Muffelzange  
Holding tongs and special crucible tongsTiegelzangen  
Crucible tongs**1**

**HWN 334-25**  
250 mm  
Haltezange für Isotopenfläschchen mit Spezialhalterung, Winkellänge 100 mm  
Holding tong for little isotope bottles with a special holder; length of angle 100 mm



**HWN 337-35**  
**Hammacher**  
350 mm  
Spezial-Muffelzange  
Special crucible tongs



**HWN 338-55**  
**Hammacher**  
550 mm  
Spezial-Muffelzange  
Special crucible tongs

**3**

1

# Tiegelzangen Crucible tongs

# Tiegel- und Küvettenzange Crucible and bulb tongs

H

aus rostfreiem Stahl  
from stainless steel

mit Scherengang  
with scissor motion



**HSN 330-22**  
220 mm  
Ø 4,5 mm

**HSN 331-25**  
250 mm  
Ø 5,0 mm

**HSN 332-30**  
300 mm  
Ø 5,0 mm

**HSN 333-40**  
400 mm  
Ø 6,0 mm

**HSN 334-50**  
500 mm  
Ø 7,0 mm

**HSN 335-60**  
600 mm  
Ø 8,0 mm  
Tiegelzangen, rostfrei  
Crucible tongs, stainless



**HSN 338-55**  
550 mm  
Ø 6 mm  
Küvettenzange, rostfrei  
bulb tongs, stainless



**HSN 355-20**  
200 mm

**HSN 356-22**  
220 mm

**HSN 357-25**  
250 mm

**HSN 358-30**  
300 mm

**HSN 359-40**  
400 mm

**HSN 360-50**  
500 mm

**HSN 360-60**  
600 mm  
Tiegelzangen, doppelt gebogen  
Crucible tongs, double curved

4

**Zeichenerklärung**  
**Explication of abbreviations**

L = Gesamtlänge      SB = Spatelbreite      SL = Spatellänge      LB = Löffelbreite      LL = Löffellänge  
L = Length overall      SB = Width of spatula      SL = Length of spatula      LB = Width of spoon      LL = Length of spoon



<b>L-HWH 217-00</b>	<b>L-HWH 218-00</b>	<b>L-HWH 220-00</b> no. 324	<b>L-HWH 221-00</b> no. 336	<b>L-HWH 225-00</b>	<b>L-HWH 226-00</b>	<b>L-HWH 227-00</b>	<b>L-HWH 228-00</b>
L = 155 mm	L = 155 mm	L = 177 mm	L = 178 mm	L = 175 mm	L = 180 mm	L = 180 mm	L = 180 mm
SB = 5 mm	SB = 5 mm	SB = 6 mm	SB = 10 mm	SB = 3 mm	SB = 5 mm	SB = 6 mm	SB = 7 mm
SL = 30 mm	SL = 30 mm	SL = 50 mm	SL = 44 mm	SL = 30 mm	SL = 30 mm	SL = 30 mm	SL = 30 mm

Mischspatel  
Mixing spatulas

Separierspatel  
Separating spatula

Mischspatel  
Mixing spatulas

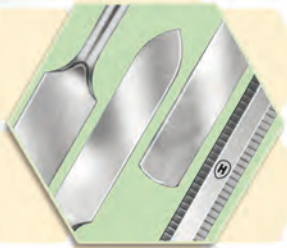

Solingen

**L-HSH 098-00**L = 175 mm  
SB = 5 mm  
SL = 30 mm**L-HSH 101-00**L = 180 mm  
SB = 6,55 mm  
SL = 30 mm**L-HSH 102-00**L = 180 mm  
SB = 10 mm / 8 mm  
SL = 35 mm / 30 mm**HSB 106-00**L = 160 mm  
SL = 10 mm  
Achat spatel  
Spatula of agate**HSB 563-00**L = 100 mm  
Glasspatel  
Glass spatula**HWL 010-05**no. 5  
L = 190 mm  
SB = 10 mm  
SL = 20 mm  
Mischspatel, doppelendig  
Mixing spatula, double-ended*Spatel, doppelendig  
Spatulas, double-ended*

**Zeichenerklärung**  
**Explication of abbreviations**

L = Gesamtlänge      SB = Spatelbreite      SL = Spatellänge      LB = Löffelbreite      LL = Löffellänge  
L = Length overall      SB = Width of spatula      SL = Length of spatula      LB = Width of spoon      LL = Length of spoon



**HWN 250-18**  
L = 180 mm  
SB = 18 mm  
SL = 90 mm

**HWN 253-25**  
L = 250 mm  
SB = 20 mm  
SL = 150 mm

**HWN 260-15**  
L = 155 mm  
SB = 8 mm  
SL = 55 mm

**HWN 251-20**  
L = 200 mm  
SB = 18 mm  
SL = 110 mm

**HWN 254-27**  
L = 275 mm  
SB = 20 mm  
SL = 180 mm

**HWN 261-15**  
L = 155 mm  
SB = 10 mm  
SL = 55 mm

**HWN 252-22**  
L = 220 mm  
SB = 18 mm  
SL = 125 mm  
Spatelmesser  
Spatula knives

**HWN 255-29**  
L = 295 mm  
SB = 20 mm  
SL = 195 mm

**HWN 262-15**  
L = 155 mm  
SB = 15 mm  
SL = 55 mm  
Schnittheber  
Section lifter

**HWN 270-21**  
L = 230 mm  
SB = 21 mm  
SL = 110 mm

**HWN 271-21**  
L = 210 mm  
SB = 30 mm  
SL = 115 mm

**HWN 272-22**  
L = 220 mm  
SB = 24 - 44 mm  
SL = 115 mm

**HWN 273-21**  
L = 215 mm  
SB = 20 - 28 mm  
SL = 110 mm

**HWN 265-15**  
L = 150 mm  
SB = 10 mm  
SL = 55 mm  
Mikrospatel mit Metallheft  
Micro spatula with metal handle

Misch- und Laborspatel mit Holzgriff  
Mixing spatulas with wooden handle

**Zeichenerklärung**  
**Explication of abbreviations**

<i>L</i> = Gesamtlänge	<i>SB</i> = Spatelbreite	<i>SL</i> = Spatellänge	<i>LB</i> = Löffelbreite	<i>LL</i> = Löffellänge
<i>L</i> = Length overall	<i>SB</i> = Width of spatula	<i>SL</i> = Length of spatula	<i>LB</i> = Width of spoon	<i>LL</i> = Length of spoon



**HWN 001-02**  
L = 140 mm  
SB = 2 mm  
SL = 23 mm



**HWN 003-04**  
L = 140 mm  
SB = 4 mm  
SL = 21 mm



**HWN 005-03**  
L = 140 mm  
SB = 3 mm  
SL = 20 mm



**HWN 008-04**  
L = 140 mm  
SB = 4 mm  
SL = 21 mm



**HWN 010-00**  
L = 140 mm  
LB = 5 mm  
LL = 7 mm  
Mikrolöffel Micro spoon

**HWN 002-03**  
L = 140 mm  
SB = 3 mm  
SL = 23 mm

**HWN 004-05**  
L = 140 mm  
SB = 5 mm  
SL = 21 mm

**HWN 006-04**  
L = 140 mm  
SB = 4 mm  
SL = 20 mm

**HWN 009-05**  
L = 140 mm  
SB = 5 mm  
SL = 21 mm

\_\_\_\_\_ Mikrospatel, einendig \_\_\_\_\_  
Micro spatulas, single-ended

**HWN 007-05**  
L = 140 mm  
SB = 5 mm  
SL = 20 mm  
Mikro-Pulverspatel  
Micro powder spatulas

\_\_\_\_\_ Mikrospatel, löffelförmig gebogen \_\_\_\_\_  
Micro spatulas, spoon-formed bent



**Wironit Instrumente sind aus einer Speziallegierung gefertigt und weisen folgende Vorteile auf:**

- ✓ nichtrostend
- ✓ antimagnetisch
- ✓ säurebeständig

Sie sind formschön, liegen leicht in der Hand und sind von langer Lebensdauer.



**Wironit instruments are made of a special alloy and show the following advantages:**

- ✓ rust resistant
- ✓ anti-magnetic
- ✓ acid resistant

They are beautifully designed and of unlimited durability.

**Zeichenerklärung**  
**Explication of abbreviations***L = Gesamtlänge*  
*L = Length overall**SB = Spatelbreite*  
*SB = Width of spatula**SL = Spatellänge*  
*SL = Length of spatula**LB = Löffelbreite*  
*LB = Width of spoon**LL = Löffellänge*  
*LL = Length of spoon***HWN 150-01**  
180 mm  
Laborspatel, spitz  
Laboratory spatula, pointed**HWN 150-02**  
180 mm  
Laborspatel, konisch  
Laboratory spatula, conical**HWN 150-03**  
180 mm  
Laborspatel, gerade, U-Form  
Laboratory spatula, straight,  
U-shape**HWN 150-04**  
180 mm  
Laborspatel, eckig  
Laboratory spatula, square**HWN 150-05**  
180 mm  
Laborspatel, gerade, V-Form  
Laboratory spatula, straight,  
V-shape

**Zeichenerklärung**  
**Explication of abbreviations**

L = Gesamtlänge      SB = Spatelbreite      SL = Spatellänge  
 L = Length overall      SB = Width of spatula      SL = Length of spatula



**HWN 013-12**  
 L = 120 mm  
 SB = 6 mm  
 SL = 28 mm  
 Ø = 2,5 mm



**HWN 014-15**  
 L = 150 mm  
 SB = 9 mm  
 SL = 30 mm  
 Ø = 3,5 mm

**HWN 019-13**  
 L = 130 mm  
 SB = 4 mm  
 SL = 28 mm  
 Ø = 2,0 mm



**HWN 024-13**  
 L = 130 mm  
 SB = 5 mm  
 SL = 26 mm  
 Ø = 2,0 mm



**HWN 029-13**  
 L = 130 mm  
 SB = 5 mm  
 SL = 28 mm  
 Ø = 2,0 mm



**HWN 034-15**  
 L = 150 mm  
 SB = 7 mm  
 SL = 28 mm  
 Ø = 2,5 mm



**HWN 038-12**  
 L = 120 mm  
 SB = 4 mm  
 SL = 25 mm  
 Ø = 2,0 mm



**HWN 043-18**  
 L = 180 mm  
 SB = 11 mm  
 SL = 40 mm  
 Ø = 4,0 mm

**HWN 015-18**  
 L = 180 mm  
 SB = 9 mm  
 SL = 35 mm  
 Ø = 3,5 mm

**HWN 020-15**  
 L = 150 mm  
 SB = 4 mm  
 SL = 28 mm  
 Ø = 2,0 mm

**HWN 025-18**  
 L = 185 mm  
 SB = 5 mm  
 SL = 30 mm  
 Ø = 2,0 mm

**HWN 030-18**  
 L = 185 mm  
 SB = 5 mm  
 SL = 30 mm  
 Ø = 2,0 mm

**HWN 035-18**  
 L = 180 mm  
 SB = 7 mm  
 SL = 28 mm  
 Ø = 2,5 mm  
 Doppelspatel  
 Spatulas,  
 double-ended

**HWN 040-15**  
 L = 150 mm  
 SB = 9 mm  
 SL = 36 mm  
 Ø = 3,5 mm

**HWN 045-21**  
 L = 210 mm  
 SB = 11 mm  
 SL = 40 mm  
 Ø = 4,0 mm

**HWN 016-21**  
 L = 210 mm  
 SB = 9 mm  
 SL = 38 mm  
 Ø = 3,5 mm  
 Einwiegespatel  
 Weighing spatulas

**HWN 021-18**  
 L = 180 mm  
 SB = 5 mm  
 SL = 30 mm  
 Ø = 2,0 mm  
 Mikro-Einwiegespatel  
 Micro weighing spatulas

**HWN 026-21**  
 L = 210 mm  
 SB = 5 mm  
 SL = 30 mm  
 Ø = 2,0 mm  
 Mikrospatel, einendig  
 Micro spatulas, single ended

**HWN 031-21**  
 L = 210 mm  
 SB = 5 mm  
 SL = 30 mm  
 Ø = 2,0 mm  
 Mikrospatel, doppelendig  
 Micro spatulas, double-ended

**HWN 041-15**  
 L = 150 mm  
 SB = 11 mm  
 SL = 38 mm  
 Ø = 4,0 mm

**HWN 046-24**  
 L = 240 mm  
 SB = 12 mm  
 SL = 60 mm  
 Ø = 4,0 mm

**HWN 042-18**  
 L = 180 mm  
 SB = 9 mm  
 SL = 38 mm  
 Ø = 3,5 mm  
 Doppelspatel  
 Spatulas, double-ended

**HWN 047-30**  
 L = 300 mm  
 SB = 13 mm  
 SL = 60 mm  
 Ø = 5,0 mm



**HWN 050-21**  
 L = 210 mm  
 SB = 12 mm  
 SL = 40 mm  
 Ø = 4,0 mm

**HWN 05 I-18**  
 L = 180 mm  
 SB = 10 mm  
 SL = 38 mm  
 Ø = 3,5 mm

**HWN 052-15**  
 L = 150 mm  
 SB = 9 mm  
 SL = 33 mm  
 Ø = 3,5 mm  
 Doppelspatel  
 Spatulas,  
 double-ended

**Zeichenerklärung**  
**Explication of abbreviations**

L = Gesamtlänge      SB = Spatelbreite      SL = Spatellänge  
L = Length overall      SB = Width of spatula      SL = Length of spatula



**HWN 055-15**  
L = 150 mm  
SB = 4 mm  
SL = 28 mm  
Ø = 2,0 mm

**HWN 059-12**  
L = 120 mm  
SB = 3 mm  
SL = 28 mm  
Ø = 2 mm

**HWN 056-18**  
L = 180 mm  
SB = 5 mm  
SL = 30 mm  
Ø = 2,0 mm  
Mikro-Doppelspatel  
Micro spatulas,  
double-ended

**HWN 060-13**  
L = 130 mm  
SB = 4 mm  
SL = 30 mm  
Ø = 2 mm  
Rührspatel  
Stirring spatulas

**HWN 070-12**    **HWN 071-19**  
L = 125 mm    L = 195 mm  
Ø = 2 mm      Ø = 4 mm  
Rührstab      Rührstab  
Stirring rod    Stirring rod

**HWN 072-19**  
L = 195 mm  
Ø = 4 mm

**HWN 074-15**  
L = 150 mm  
Ø = 3 mm

**HWN 076-19**  
**Hünebeck**  
L = 190 mm  
Ø = 3 mm  
abgewinkelt 10°  
angular 10°

Drigalski-Spatel, einendig  
Drigalski spatula, single-ended

**Zeichenerklärung**  
**Explication of abbreviations**

L = Gesamtlänge      SB = Spatelbreite      SL = Spatellänge  
L = Length overall      SB = Width of spatula      SL = Length of spatula



**HSN 001-10**  
L = 100 mm  
SB = 2 mm  
SL = 30 mm  
Ø = 1,2 mm

**HSN 002-13**  
L = 130 mm  
SB = 2 mm  
SL = 40 mm  
Ø = 1,2 mm

**HSN 003-15**  
L = 150 mm  
SB = 2 mm  
SL = 40 mm  
Ø = 1,2 mm  
Mikro-Doppelspatel, flexibel  
Micro spatulas, double-ended,  
flexible



**HSN 006-10**  
L = 100 mm  
SB = 3 mm  
SL = 35 mm  
Ø = 1,8 mm

**HSN 007-13**  
L = 130 mm  
SB = 3 mm  
SL = 40 mm  
Ø = 1,8 mm

**HSN 008-15**  
L = 150 mm  
SB = 3 mm  
SL = 40 mm  
Ø = 1,8 mm

**HSN 009-18**  
L = 185 mm  
SB = 3 mm  
SL = 50 mm  
Ø = 1,8 mm  
Mikro-Doppelspatel, flexibel  
Micro spatulas, double-ended, flexible



**HSN 011-15**  
L = 150 mm  
SB = 3 mm  
SL = 40 mm  
Ø = 1,8 mm

**HSN 012-18**  
L = 185 mm  
SB = 3 mm  
SL = 50 mm  
Ø = 1,8 mm  
Mikro-Pulverspatel, flexibel  
Micro powder spatulas,  
flexible



**HSN 014-10**  
L = 100 mm  
SB = 4 mm  
SL = 35 mm  
Ø = 2,0 mm

**HSN 016-15**  
L = 150 mm  
SB = 4 mm  
SL = 40 mm  
Ø = 2,0 mm

**HSN 018-21**  
L = 210 mm  
SB = 4 mm  
SL = 55 mm  
Ø = 2,0 mm  
Mikro-Doppelspatel,  
flexibel  
Micro spatulas,  
double-ended, flexible



**HSN 021-13**  
L = 130 mm  
SB = 4 mm  
SL = 40 mm  
Ø = 2,0 mm

**HSN 022-15**  
L = 150 mm  
SB = 4 mm  
SL = 40 mm  
Ø = 2,0 mm

**HSN 023-18**  
L = 185 mm  
SB = 4 mm  
SL = 50 mm  
Ø = 2,0 mm

**HSN 024-21**  
L = 210 mm  
SB = 4 mm  
SL = 55 mm  
Ø = 2,0 mm  
Mikro-Pulverspatel, flexibel  
Micro powder spatulas, flexible



**HSN 028-15**  
L = 150 mm  
SB = 5 mm  
SL = 40 mm  
Ø = 2,0 mm

Mikro-Doppelspatel, flexibel  
Micro spatulas, double ended,  
flexible

**Zeichenerklärung**  
*Explication of abbreviations**L = Gesamtlänge*  
*L = Length overall**SB = Spatelbreite*  
*SB = Width of spatula**SL = Spatellänge*  
*SL = Length of spatula**LB = Löffelbreite*  
*LB = Width of spoon**LL = Löffellänge*  
*LL = Length of spoon***HSN 033-15**  
L = 150 mm  
SB = 5 mm  
SL = 40 mm  
Ø = 2,0 mm**HSN 036-13**  
L = 130 mm  
SB = 6 mm  
SL = 40 mm  
Ø = 2,5 mm**HSN 042-13**  
L = 130 mm  
SB = 6 mm  
SL = 40 mm  
Ø = 2,5 mm**HSN 047-13**  
L = 130 mm  
SB = 5 mm  
SL = 10 mm  
Ø = 2,0 mm**HSN 053-13**  
L = 130 mm  
SB = 5 mm  
SL = 10 mm  
Ø = 2,0 mm**HSN 060-10**  
L = 100 mm  
SB = 6 mm LB = 5 mm  
SL = 35 mm LL = 7 mm  
Ø = 2,2 mm**HSN 034-18**  
L = 185 mm  
SB = 5 mm  
SL = 50 mm  
Ø = 2,0 mm**HSN 037-15**  
L = 150 mm  
SB = 6 mm  
SL = 40 mm  
Ø = 2,5 mm**HSN 043-15**  
L = 150 mm  
SB = 6 mm  
SL = 40 mm  
Ø = 2,5 mm**HSN 048-15**  
L = 150 mm  
SB = 5 mm  
SL = 10 mm  
Ø = 2,0 mm**HSN 054-15**  
L = 150 mm  
SB = 5 mm  
SL = 10 mm  
Ø = 2,0 mm**HSN 061-15**  
L = 150 mm  
SB = 6 mm LB = 5 mm  
SL = 40 mm LL = 7 mm  
Ø = 2,2 mmMikro-Pulverspatel, flexibel  
Micro powder spatulas,  
flexible**HSN 038-18**  
L = 185 mm  
SB = 6 mm  
SL = 50 mm  
Ø = 2,5 mm**HSN 044-18**  
L = 185 mm  
SB = 6 mm  
SL = 50 mm  
Ø = 2,5 mm**HSN 049-18**  
L = 185 mm  
SB = 5 mm  
SL = 10 mm  
Ø = 2,0 mm**HSN 055-18**  
L = 185 mm  
SB = 5 mm  
SL = 10 mm  
Ø = 2,0 mm**HSN 062-18**  
L = 185 mm  
SB = 6 mm LB = 5 mm  
SL = 50 mm LL = 7 mm  
Ø = 2,2 mm**HSN 039-21**  
L = 210 mm  
SB = 6 mm  
SL = 55 mm  
Ø = 2,5 mm  
Mikro-Doppelspatel, flexibel  
Micro spatulas, double  
ended, flexible**HSN 045-21**  
L = 210 mm  
SB = 6 mm  
SL = 55 mm  
Ø = 2,5 mm  
Mikro-Pulverspatel, flexibel  
Micro powder spatulas,  
flexible**HSN 050-21**  
L = 210 mm  
SB = 5 mm  
SL = 10 mm  
Ø = 2,0 mm  
Mikro-Doppelspatel,  
löffelförmig  
Micro spatulas, double-ended,  
both ends spoon-formed**HSN 056-21**  
L = 210 mm  
SB = 5 mm  
SL = 10 mm  
Ø = 2,0 mm  
Mikrospatel, löffelförmig  
Micro spatulas, one-end  
spoon-formed**HSN 063-21**  
L = 210 mm  
SB = 6 mm LB = 5 mm  
SL = 55 mm LL = 7 mm  
Ø = 2,2 mm  
Mikrolöffelspatel,  
Löffel 5 x 7 mm  
Micro spoon spatulas,  
spoon 5 x 7 mm

Zeichenerklärung  
Explication of abbreviationsL = Gesamtlänge  
L = Length overallSB = Spatelbreite  
SB = Width of spatulaSL = Spatellänge  
SL = Length of spatulaLB = Löffelbreite  
LB = Width of spoonLL = Löffellänge  
LL = Length of spoon

**HSN 067-13**  
L = 130 mm  
SB = 10 mm  
SL = 45 mm  
Ø = 3,0 mm



**HSN 075-15**  
L = 150 mm  
SB = 10 mm  
SL = 50 mm  
Ø = 3,0 mm



**HSN 088-13**  
L = 130 mm  
SB = 9 mm  
SL = 45 mm  
Ø = 3,0 mm



**HSN 095-30**  
L = 300 mm  
SB = 15 mm  
SL = 70 mm  
Ø = 5,0 mm



**HSN 119-23**  
L = 230 mm  
SB = 10 mm ▼  
SL = 60 mm  
SB = 12 mm ▲  
SL = 30 mm  
Ø = 4,0 mm  
Doppelspatel,  
ein Ende birnenförmig  
Spatula, double-ended,  
one end pear-shaped

**HSN 068-15**  
L = 150 mm  
SB = 10 mm  
SL = 50 mm  
Ø = 3,0 mm

**HSN 069-18**  
L = 185 mm  
SB = 10 mm  
SL = 55 mm  
Ø = 3,0 mm

**HSN 070-21**  
L = 210 mm  
SB = 10 mm  
SL = 60 mm  
Ø = 3,5 mm  
Doppelspatel, flexibel  
Spatulas, double ended, flexible

**HSN 076-18**  
L = 185 mm  
SB = 10 mm  
SL = 50 mm  
Ø = 3,0 mm

**HSN 077-21**  
L = 210 mm  
SB = 10 mm  
SL = 50 mm  
Ø = 3,0 mm  
Pulverspatel, flexibel  
Powder spatulas, flexible

**HSN 089-15**  
L = 150 mm  
SB = 10 mm  
SL = 50 mm  
Ø = 3,5 mm

**HSN 090-18**  
L = 185 mm  
SB = 10 mm  
SL = 55 mm  
Ø = 3,5 mm

**HSN 091-21**  
L = 210 mm  
SB = 11 mm  
SL = 60 mm  
Ø = 4,0 mm

**HSN 092-25**  
L = 250 mm  
SB = 11 mm  
SL = 60 mm  
Ø = 4,0 mm  
Doppelspatel, starr  
Spatulas, double-ended,  
non-flexible

**HSN 096-35**  
L = 350 mm  
SB = 15 mm  
SL = 70 mm  
Ø = 5,0 mm

**HSN 097-40**  
L = 400 mm  
SB = 20 mm  
SL = 70 mm  
Ø = 6,0 mm

**HSN 098-50**  
L = 500 mm  
SB = 20 mm  
SL = 70 mm  
Ø = 6,0 mm  
Doppelspatel, schmale Form  
Spatulas, double-ended, narrow type

**Zeichenerklärung**  
*Explication of abbreviations*

L = Gesamtlänge      SB = Spatelbreite      SL = Spatellänge      LB = Löffelbreite      LL = Löffellänge  
L = Length overall      SB = Width of spatula      SL = Length of spatula      LB = Width of spoon      LL = Length of spoon



**HSN 121-18**  
L = 180 mm  
LB = 10 mm  
LL = 20 mm  
Ø = 3,5 mm

**HSN 122-21**  
L = 210 mm  
LB = 10 mm  
LL = 20 mm  
Ø = 3,5 mm  
Doppelspatel,  
beide Seiten löffelförmig  
Spatulas, double-ended,  
both ends spoon-formed



**HSN 129-18**  
L = 180 mm  
SB = 10 mm ▼  
SL = 35 mm  
LB = 10 mm ▲  
LL = 20 mm  
Ø = 3,5 mm

**HSN 130-21**  
L = 210 mm  
SB = 10 mm ▼  
SL = 35 mm  
LB = 10 mm ▲  
LL = 20 mm  
Ø = 3,5 mm  
Doppelspatel, eine  
Seite löffelförmig, eine  
Seite Spatel  
Spatulas, double-ended,  
one end spoon-formed,  
one end spatula



**HSN 181-10**  
L = 100 mm  
SB = 7 mm  
SL = 30 mm

**HSN 182-12**  
L = 125 mm  
SB = 7 mm  
SL = 40 mm

**HSN 183-15**  
L = 150 mm  
SB = 7 mm  
SL = 40 mm

**HSN 184-18**  
L = 180 mm  
SB = 8 mm  
SL = 50 mm

**HSN 185-21**  
L = 200 mm  
SB = 9 mm  
SL = 60 mm

**HSN 186-23**  
L = 235 mm  
SB = 10 mm  
SL = 70 mm

**HSN 187-26**  
L = 265 mm  
SB = 11 mm  
SL = 70 mm  
Doppelspatel, gerade  
Spatulas, double-ended, straight



**HSN 190-10**  
L = 100 mm  
SB = 7 mm  
SL = 30 mm

**HSN 191-12**  
L = 125 mm  
SB = 7 mm  
SL = 40 mm

**HSN 192-15**  
L = 150 mm  
SB = 7 mm  
SL = 40 mm

**HSN 193-18**  
L = 180 mm  
SB = 8 mm  
SL = 50 mm

**HSN 194-20**  
L = 200 mm  
SB = 9 mm  
SL = 60 mm

**HSN 195-23**  
L = 235 mm  
SB = 10 mm  
SL = 70 mm

**HSN 196-26**  
L = 265 mm  
SB = 11 mm  
SL = 70 mm  
Doppelspatel, gebogen  
Spatulas, double-ended, curved

*Typ  
Chattaway*

*Typ  
Chattaway*



**HSN 197-10**  
L = 100 mm  
SB = 8 mm  
SL = 35 mm

**HSN 197-15**  
L = 150 mm  
SB = 10 mm  
SL = 50 mm

**HSN 197-20**  
L = 200 mm  
SB = 10 mm  
SL = 55 mm  
Spatel, doppelendig  
Spatula, double-ended



**HSN 198-10**  
L = 100 mm  
SB = 4 mm  
SL = 33 mm

**HSN 198-15**  
L = 150 mm  
SB = 4 mm  
SL = 48 mm

**HSN 198-20**  
L = 200 mm  
SB = 3 mm  
SL = 58 mm  
Mikrospatel, doppelendig  
Micro spatula, double-ended

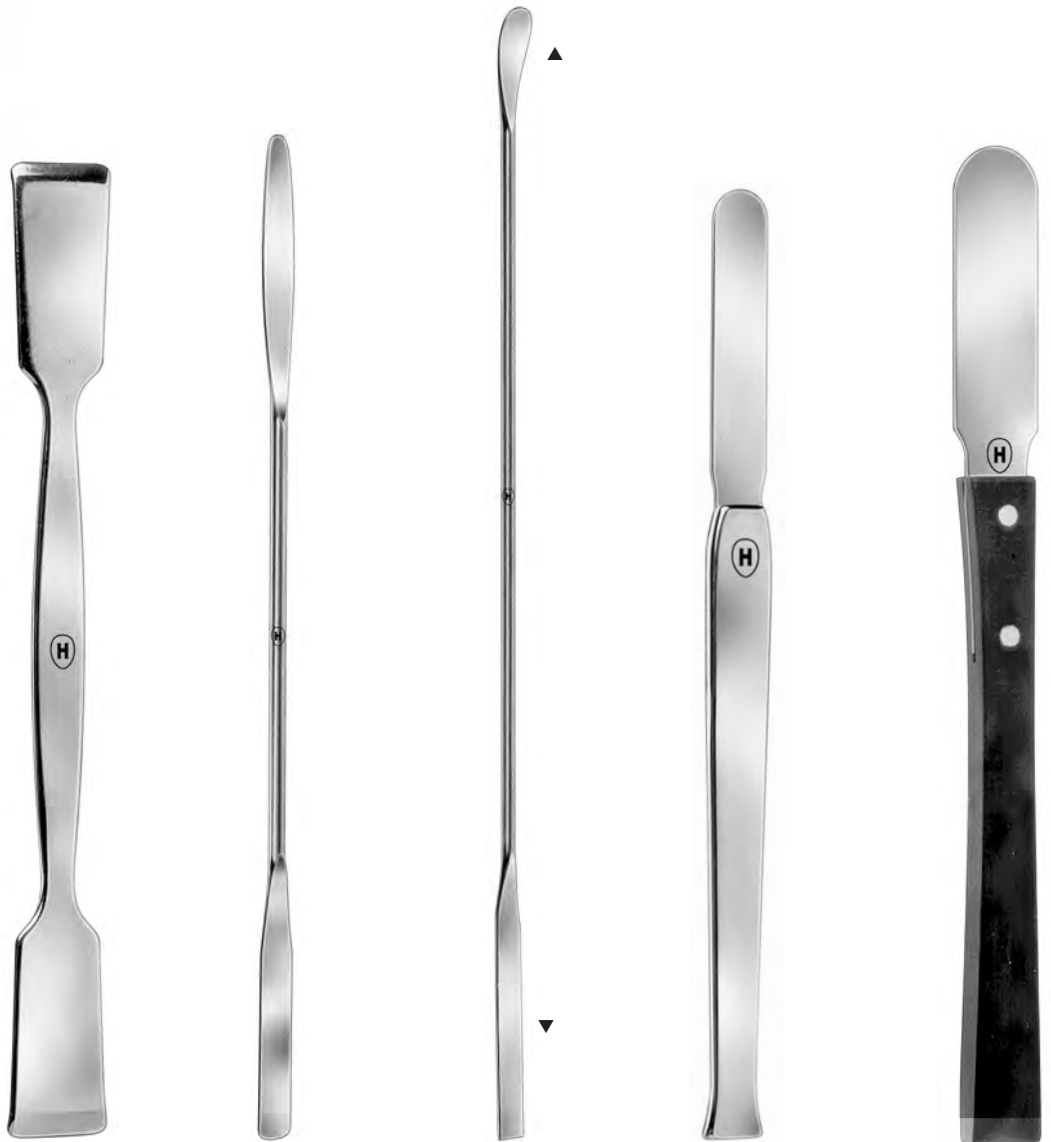
**Zeichenerklärung**  
*Explication of abbreviations**L = Gesamtlänge*  
*L = Length overall**SB = Spatelbreite*  
*SB = Width of spatula**SL = Spatellänge*  
*SL = Length of spatula***HSN 400-15**  
L = 150 mm  
SB = 15 mm  
SL = 32 mm**HSN 401-21**  
L = 210 mm  
SB = 18 mm  
SL = 36 mm  
Doppelspatel  
Spatulas, double-ended**HSN 416-14**  
L = 140 mm  
SB = 6 mm  
SL = 45 mm**HSN 417-16**  
L = 160 mm  
SB = 6 mm  
SL = 45 mm**HSN 418-21**  
L = 210 mm  
SB = 6 mm  
SL = 45 mm  
Mikrospatel,  
amerikanische Form  
Micro spatulas,  
American pattern**HSN 421-15**  
L = 150 mm  
SB = 5 mm  
SL = 10 mm ▲  
SL = 45 mm ▼**HSN 422-18**  
L = 185 mm  
SB = 5 mm  
SL = 10 mm ▲  
SL = 50 mm ▼  
Mikrodoppelspatel,  
ein Ende birnenförmig  
Micro spatulas, double-  
ended, one end pear-  
shaped**HSN 430-10**  
L = 150 mm  
SB = 10 mm  
SL = 50 mm**HSN 431-15**  
L = 150 mm  
SB = 15 mm  
SL = 50 mm**HSN 432-20**  
L = 150 mm  
SB = 20 mm  
SL = 50 mm  
Schnittfänger; Klinge flexibel  
Section lifter; flexible**HSN 443-10**  
L = 150 mm  
SB = 10 mm  
SL = 50 mm**HSN 444-15**  
L = 150 mm  
SB = 15 mm  
SL = 50 mm  
Schnittfänger; Klinge flexibel  
Section lifter; flexible

Solingen

aus rostfreiem Stahl  
from stainless steel

**Zeichenerklärung**  
*Explication of abbreviations*

L = Gesamtlänge      SB = Spatelbreite      SL = Spatellänge  
L = Length overall      SB = Width of spatula      SL = Length of spatula

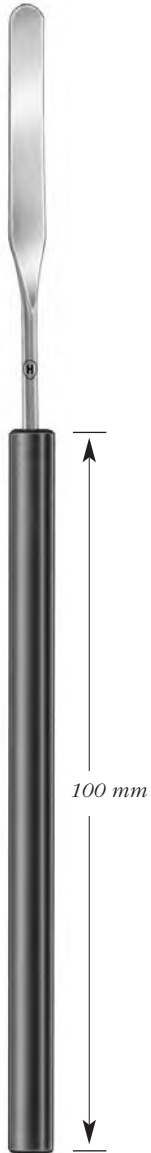

**HSN 434-03**  
L = 160 mm  
SB = 3 mm  
SL = 45 mm

**HSN 435-04**  
L = 160 mm  
SB = 4 mm  
SL = 45 mm  
Mikrospatel mit schwarzem Plastikgriff  
Micro spatulas with black plastic handle

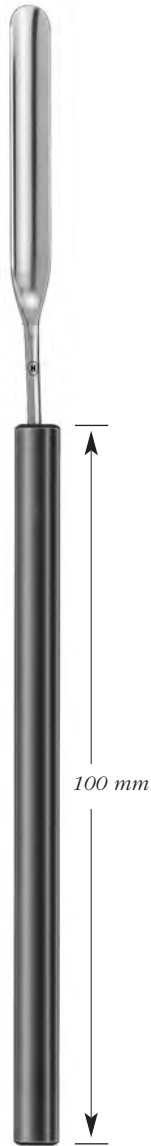

**HSN 436-05**  
L = 160 mm  
SB = 5 mm  
SL = 45 mm

**HSN 437-06**  
L = 160 mm  
SB = 6 mm  
SL = 45 mm

**HSN 447-03**  
L = 160 mm  
SB = 3 mm  
SL = 45 mm

**HSN 448-04**  
L = 160 mm  
SB = 4 mm  
SL = 45 mm  
Mikropulverspatel  
Micro powder spatulas

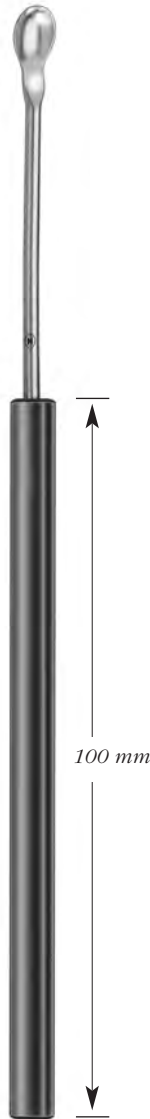

**HSN 452-16**  
L = 160 mm  
LB = 5 mm  
LL = 9 mm  
Mikrolöffel  
Micro spoon

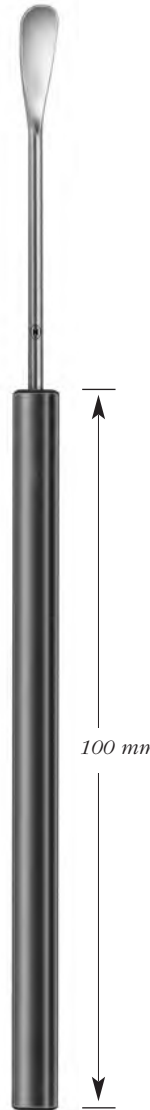

**HSN 453-16**  
L = 160 mm  
SB = 5 mm  
SL = 10 mm  
Mikrospatel, birnenförmig  
Micro spatula, pear-shaped



**HWN 011-18**  
180 mm  
Mikrolöffel mit Drahtende, für Rechtshänder  
Micro spoon with wire end, for right-handed

**HWN 012-18**  
180 mm  
Mikrolöffel mit Drahtende, für Linkshänder  
Micro spoon with wire end, for left-handed

**Zeichenerklärung**  
**Explication of abbreviations**

L = Gesamtlänge	SB = Spatelbreite	SL = Spatellänge	LB = Löffelbreite	LL = Löffellänge
L = Length overall	SB = Width of spatula	SL = Length of spatula	LB = Width of spoon	LL = Length of spoon



**HANDHABUNG!**  
Rädchen mit leichtem Druck drehen, Sie erreichen eine feine Dosierung.

**HANDLING!**  
Turn small wheel using light pressure and you obtain precise dosage.

**HSN 458-17**

L = 180 mm  
SB = 10 mm  
SL = 46 mm  
Vibrationsspatel, flach, leicht gebogen, mit säurebeständigem Kunststoffgriff  
Vibration spatula, flat, slightly curved, with acid-proof plastic handle

**HSN 458-17T**

L = 180 mm  
SB = 10 mm  
SL = 46 mm  
Vibrationsspatel, flach, leicht gebogen, teflonbeschichtet, mit säurebeständigem Kunststoffgriff  
Vibration spatula, flat, slightly curved, Teflon coated, with acid-proof plastic handle

**HSN 461-22**

L = 210 mm  
SB = 5 mm  
SL = 18 mm  
Vibrationsspatel, schmal, mit säurebeständigem Kunststoffgriff  
Vibration spatula, narrow, with acid-proof plastic handle

**HSN 462-22**

L = 220 mm  
SB = 5 mm  
SL = 18 mm  
Vibrationsspatel, mit säurebeständigem Kunststoffgriff, teflonbeschichtet, mit extra feinem Arbeitsteil, feine Dosierung  
Vibration spatula, with acid-proof plastic handle, teflon-coated, with extra-fine work part, fine dosing

**HSN 463-18**

L = 185 mm  
SB = 10 mm  
SL = 35 mm  
Vibrationsspatel, Dosierspatel mit säurebeständigem Kunststoffgriff  
Vibration spatula, with acid-proof plastic handle

**HSN 463-18T**

L = 185 mm  
SB = 10 mm  
SL = 35 mm  
Vibrationsspatel / Dosierspatel, teflonbeschichtet, mit säurebeständigem Kunststoffgriff  
Vibration spatula / dosing spatula, Teflon coated, with acid-proof plastic handle

**Zeichenerklärung**  
**Explication of abbreviations**

L = Gesamtlänge    SB = Spatelbreite    SL = Spatellänge    LB = Löffelbreite    LL = Löffellänge  
L = Length overall    SB = Width of spatula    SL = Length of spatula    LB = Width of spoon    LL = Length of spoon

Teflonbeschichtet  
Teflon-coated



**HSN 403-12T**

L = 120 mm  
SB = 20 mm    LB = 23 mm  
SL = 30 mm    LL = 31 mm

**HSN 405-18T**

L = 180 mm  
SB = 26 mm    LB = 28 mm  
SL = 36 mm    LL = 40 mm

**HSN 404-15T**

L = 150 mm  
SB = 22 mm    LB = 26 mm  
SL = 32 mm    LL = 36 mm  
Löffel-Spatel, teflonbeschichtet  
Spoon spatula, teflon-coated

**HSN 406-21T**

L = 210 mm  
SB = 26 mm    LB = 28 mm  
SL = 36 mm    LL = 40 mm

**HSN 088-13T**

L = 130 mm  
SB = 9 mm  
SL = 45 mm  
Ø = 3,0 mm

**HSN 090-18T**

L = 180 mm  
SB = 10 mm  
SL = 55 mm  
Ø = 3,5 mm

**HSN 089-15T**

L = 150 mm  
SB = 10 mm  
SL = 50 mm  
Ø = 3,5 mm  
Spatel, doppelendig, teflonbeschichtet  
Spatula, double-ended, teflon-coated

**HSN 091-21T**

L = 210 mm  
SB = 11 mm  
SL = 60 mm  
Ø = 4,0 mm

**HSN 008-15T**

L = 150 mm  
SB = 3 mm  
SL = 40 mm  
Ø = 1,8 mm

**HSN 017-18T**

L = 185 mm  
SB = 4 mm  
SL = 50 mm  
Ø = 2,0 mm

**HSN 039-21T**

L = 210 mm  
SB = 6 mm  
SL = 55 mm  
Ø = 2,5 mm  
Mikrospatel, doppelendig, teflonbeschichtet  
Micro spatula, double-ended, teflon-coated

**HSN 075-15T**

L = 150 mm  
SB = 10 mm  
SL = 50 mm  
Ø = 3 mm  
Pulverspatel, doppelendig,  
teflonbeschichtet  
Powder spatula, double-ended,  
teflon-coated

**Zeichenerklärung**  
**Explication of abbreviations**

L = Gesamtlänge      SB = Spatelbreite      SL = Spatellänge  
L = Length overall      SB = Width of spatula      SL = Length of spatula

*flexibel*  
*flexible***HSN 200-08**

L = 160 mm  
SB = 15 mm  
SL = 80 mm

**HSN 204-18**

L = 285 mm  
SB = 25 mm  
SL = 180 mm

**HSN 201-10**

L = 190 mm  
SB = 17 mm  
SL = 105 mm

**HSN 205-21**

L = 310 mm  
SB = 27 mm  
SL = 210 mm

**HSN 202-13**

L = 220 mm  
SB = 20 mm  
SL = 130 mm

— Apothekerspatel, flexibel —  
— Chemist's spatula, flexible —

**HSN 210-07**

L = 165 mm  
SB = 14 mm  
SL = 75 mm

**HSN 214-20**

L = 310 mm  
SB = 32 mm  
SL = 200 mm

**HSN 211-10**

L = 190 mm  
SB = 18 mm  
SL = 100 mm

**HSN 215-25**

L = 365 mm  
SB = 38 mm  
SL = 250 mm

**HSN 212-13**

L = 230 mm  
SB = 20 mm  
SL = 130 mm

**HSN 216-30**

L = 415 mm  
SB = 42 mm  
SL = 300 mm

**HSN 213-15**

L = 250 mm  
SB = 22 mm  
SL = 150 mm

Apothekerspatel mit Holzgriff und gehärteter Klinge  
Chemist's spatula with wooden handle and hardened blade

**HSN 217-20**

L = 205 mm  
SB = 13 - 20 mm  
SL = 105 mm

Apothekerspatel mit flexibler Klinge  
Chemist's spatula with flexible blade

**HSN 218-13**

L = 230 mm  
SB = 20 mm  
SL = 130 mm

Apothekerspatel mit Metallgriff und flexibler Klinge  
Chemist's spatula with metal handle and flexible blade

aus rostfreiem Stahl  
from stainless steel

**Zeichenerklärung**  
*Explication of abbreviations*

L = Gesamtlänge      SB = Spatelbreite      SL = Spatellänge  
L = Length overall      SB = Width of spatula      SL = Length of spatula

*flexibel*  
*flexible*



**HSN 220-08**  
L = 180 mm  
SB = 10 - 15 mm  
SL = 80 mm

**HSN 225-08**  
L = 180 mm  
SB = 10 - 15 mm  
SL = 80 mm

**HSN 231-10**  
L = 205 mm  
SB = 12 - 20 mm  
SL = 105 mm

**HSN 236-10**  
L = 205 mm  
SB = 11 - 24 mm  
SL = 105 mm

**HSN 221-10**  
L = 205 mm  
SB = 10 - 18 mm  
SL = 105 mm

**HSN 226-10**  
L = 205 mm  
SB = 10 - 18 mm  
SL = 105 mm

**HSN 222-13**  
L = 230 mm  
SB = 10 - 20 mm  
SL = 130 mm  
Spatelmesser, flexibel  
Spatula knife, flexible

**HSN 227-13**  
L = 230 mm  
SB = 10 - 20 mm  
SL = 130 mm  
Spatelmesser, flexibel  
Spatula knife, flexible

Teflonbeschichtet  
Teflon-coated



**HSN 211-10T**  
L = 190 mm  
SB = 18 mm  
SL = 100 mm

**HSN 212-13T**  
L = 230 mm  
SB = 20 mm  
SL = 130 mm  
Apothekerspatel mit Holzgriff  
und gehärteter Klinge  
Chemist's spatula with wooden  
handle and hardened blade



Solingen

**Zeichenerklärung**  
**Explication of abbreviations**

<i>L = Gesamtlänge</i>	<i>SB = Spatelbreite</i>	<i>SL = Spatellänge</i>	<i>LB = Löffelbreite</i>	<i>LL = Löffellänge</i>
<i>L = Length overall</i>	<i>SB = Width of spatula</i>	<i>SL = Length of spatula</i>	<i>LB = Width of spoon</i>	<i>LL = Length of spoon</i>



**HSN 291-17**  
L = 170 mm  
**Lichtenstein**  
Misch- und Laborspatel, gerade  
Mixing spatula, straight



**HSN 290-19**  
L = 195 mm  
Misch- und Laborspatel,  
doppelseitig und leicht  
entgegengesetzt abgebogen  
Mixing spatula, double-  
ended, slightly inversed  
curved ends



**HSN 293-20**  
Misch- und Laborspatel,  
Kunststoff  
Mixing and laboratory  
spatula, plastic



**HSN 133-15**  
L = 150 mm  
SB = 10 mm LB = 17 mm  
SL = 50 mm LL = 38 mm  
Ø = 3,5 mm

**HSN 134-18**  
L = 180 mm  
SB = 10 mm LB = 17 mm  
SL = 55 mm LL = 38 mm  
Ø = 3,5 mm

**HSN 135-21**  
L = 210 mm  
SB = 10 mm LB = 17 mm  
SL = 60 mm LL = 38 mm  
Ø = 3,5 mm

**HSN 136-23**  
L = 230 mm  
SB = 10 mm LB = 17 mm  
SL = 60 mm LL = 38 mm  
Ø = 4,0 mm  
Doppelspatel, mit flachem Löffel  
Spatulas, double-ended,  
with flat spoon



**HSN 139-15**  
L = 150 mm  
SB = 15 mm LB = 22 mm  
SL = 50 mm LL = 30 mm  
Ø = 5,0 mm

**HSN 140-18**  
L = 180 mm  
SB = 20 mm LB = 29 mm  
SL = 55 mm LL = 40 mm  
Ø = 5,5 mm

**HSN 141-21**  
L = 210 mm  
SB = 20 mm LB = 29 mm  
SL = 60 mm LL = 40 mm  
Ø = 5,5 mm  
Löffelspatel  
Spoon spatulas



**HSN 151-15**  
L = 145 mm  
Spatel, Nuffiel  
Spatula, Nuffiel



**HSN 152-17**  
L = 170 mm  
Spatel, Trulla  
Spatula, Trulla

H

wironit

aus Wironit Stahl  
from Wironit steel

Doppellöffel, scharf  
Double spoons, sharp

Löffel  
Spoons

3

H

aus rostfreiem Stahl  
from stainless steel



**L-HWK 030-04** 160 mm  
**L-HWK 031-05** 160 mm  
**L-HWK 035-04** 160 mm

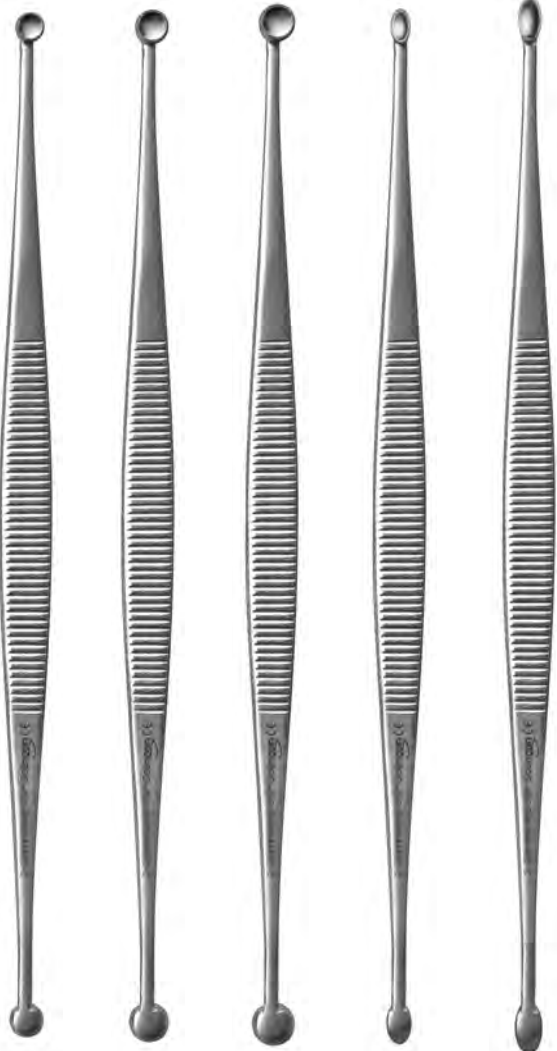

**L-HWK 040-01** 135 mm  
**Martini**  
 Ø 3 mm  
 Ø 3,5 mm  
**L-HWK 041-02** 135 mm  
**Martini**  
 Ø 3,5  
 Ø 4 mm  
**L-HWK 042-03** 135 mm  
**Martini**  
 Ø 4 mm  
 Ø 4,5 mm  
**L-HWK 045-01** 135 mm  
**Williger**  
 3,5 x 2,5 mm  
 4 x 3 mm  
**L-HWK 047-03** 135 mm  
**Williger**  
 5 x 3 mm  
 6 x 4 mm

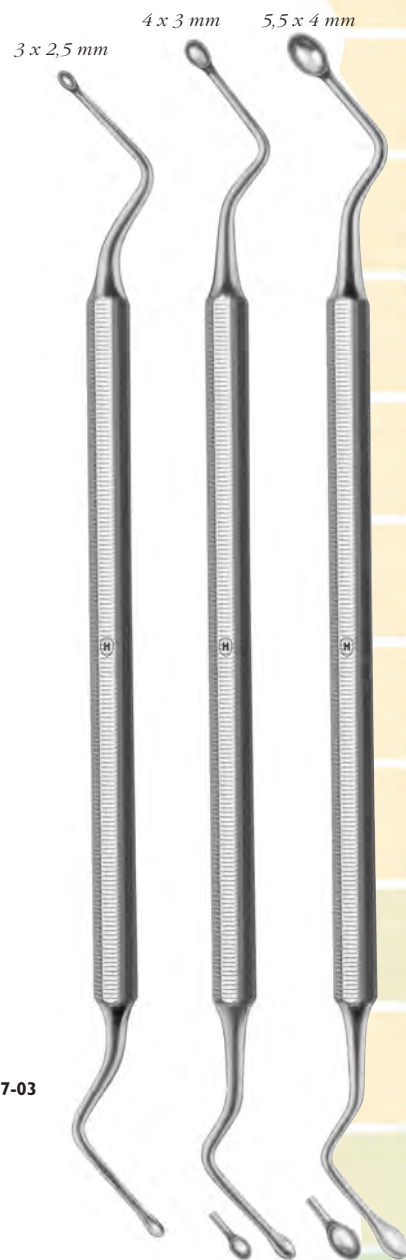

**L-HSK 115-00** 175 mm  
*fig. 0*  
**Hemingway**  
**L-HSK 116-01** 175 mm  
*fig. 1*  
**Hemingway**  
**L-HSK 117-02** 175 mm  
*fig. 2*  
**Hemingway**

**Zeichenerklärung**  
**Explication of abbreviations**

*L = Gesamtlänge*      *SB = Spatelbreite*      *SL = Spatellänge*      *LB = Löffelbreite*      *LL = Löffellänge*  
*L = Length overall*      *SB = Width of spatula*      *SL = Length of spatula*      *LB = Width of spoon*      *LL = Length of spoon*



**HWN 100-15**  
 L = 150 mm  
 SB = 8 mm  
 SL = 33 mm  
 LB = 5 mm  
 LL = 7 mm  
 Mikrolöffel  
 Micro spoon



**HWN 101-15**  
 L = 150 mm

**HWN 102-18**  
 L = 180 mm  
 Einwiegelöffel mit  
 Spatelende  
 Weighing spoons  
 with spatula-end



**HWN 106-15**  
 L = 150 mm  
 SB = 15 - 20 mm ▼  
 SL = 32 mm  
 LB = 25 mm ▲  
 LL = 35 mm

**HWN 107-18**  
 L = 180 mm  
 SB = 18 - 22 mm ▼  
 SL = 32 mm  
 LB = 25 mm ▲  
 LL = 35 mm

**HWN 108-21**  
 L = 210 mm  
 SB = 20 - 24 mm ▼  
 SL = 32 mm  
 LB = 25 mm ▲  
 LL = 35 mm  
 Löffel-Spatel  
 Spoon spatulas



**HWN 111-15**  
 L = 150 mm  
 LB = 25 mm  
 LL = 35 mm

**HWN 112-18**  
 L = 180 mm  
 LB = 25 mm  
 LL = 35 mm

**HWN 113-21**  
 L = 210 mm  
 LB = 25 mm  
 LL = 35 mm  
 Doppel-Löffel  
 Spoons, double-ended



**HWN 120-15**  
 L = 150 mm  
 LB = 20 mm  
 LL = 25 mm

**HWN 121-18**  
 L = 180 mm  
 LB = 24 mm  
 LL = 32 mm

**HWN 122-21**  
 L = 210 mm  
 LB = 27 mm  
 LL = 35 mm

**HWN 123-25**  
 L = 250 mm  
 LB = 30 mm  
 LL = 40 mm

**HWN 124-30**  
 L = 300 mm  
 LB = 35 mm  
 LL = 45 mm  
 Chemikalien-Löffel,  
 einendig  
 Chemicals scoops,  
 single-ended



**HWN 130-15**  
 L = 150 mm  
 LB = 20 mm ▲  
 LL = 25 mm ▼  
 LB = 11 mm ▼  
 LL = 22 mm

**HWN 131-18**  
 L = 180 mm  
 LB = 24 mm ▲  
 LL = 32 mm ▼  
 LB = 20 mm ▼  
 LL = 27 mm

**HWN 132-21**  
 L = 210 mm  
 LB = 27 mm ▲  
 LL = 35 mm ▼  
 LB = 20 mm ▼  
 LL = 28 mm

**HWN 133-25**  
 L = 250 mm  
 LB = 30 mm ▲  
 LL = 40 mm ▼  
 LB = 24 mm ▼  
 LL = 32 mm

**HWN 134-30**  
 L = 300 mm  
 LB = 35 mm ▲  
 LL = 45 mm ▼  
 LB = 29 mm ▼  
 LL = 40 mm  
 Chemikalien-Löffel, doppelendig  
 Chemicals scoops, double-ended



**HWN 128-20**  
 L = 200 mm  
 Ø 27 mm  
 Chemikalien-Löffel,  
 einendig, abgewinkelt  
 Chemicals scoops,  
 single-ended, angled

**Zeichenerklärung**  
**Explication of abbreviations***L* = Gesamtlänge  
*L* = Length overall*SB* = Spatelbreite  
*SB* = Width of spatula*SL* = Spatellänge  
*SL* = Length of spatula*LB* = Löffelbreite  
*LB* = Width of spoon*LL* = Löffellänge  
*LL* = Length of spoon*sbarf*  
*sharp***HWN 090-00**  
L = 130 mm  
Ø = 1,8 mm  
Mikrolöffel  
Micro spoon**HWN 090-01**  
L = 130 mm  
Ø = 2,0 mm  
Mikrolöffel  
Micro spoon**HWN 090-02**  
L = 130 mm  
Ø = 2,5 mm  
Mikrolöffel  
Micro spoon**HWN 141-14**  
L = 140 mm  
LB = 30 mm  
LL = 45 mm  
Laborlöffel  
Laboratory spoon**HWN 143-19**  
L = 195 mm  
LB = 44 mm  
LL = 60 mm  
Laborlöffel  
Laboratory spoon**HWN 144-20**  
L = 205 mm  
LB = 55 mm  
LL = 70 mm  
Laborlöffel  
Laboratory spoon**HWN 147-15**  
L = 150 mm  
LB = 16 mm  
LL = 26 mm  
Einwiegelöffel mit  
Spatelende  
Weighing spoon  
with spatula-end

**Zeichenerklärung**  
**Explication of abbreviations**

*L = Gesamtlänge*      *SB = Spatelbreite*      *SL = Spatellänge*      *LB = Löffelbreite*      *LL = Löffellänge*  
*L = Length overall*      *SB = Width of spatula*      *SL = Length of spatula*      *LB = Width of spoon*      *LL = Length of spoon*



**HSN 144-12**  
 L = 120 mm  
 LB = 22 mm  
 LL = 30 mm  
 Ø = 5,0 mm



**HSN 152-13**  
 L = 130 mm  
 LB = 17 mm ▼  
 LL = 23 mm

**HSN 153-15**  
 L = 150 mm  
 LB = 17 mm ▼  
 LL = 23 mm

**HSN 154-18**  
 L = 180 mm  
 LB = 22 mm ▼  
 LL = 30 mm

**HSN 155-21**  
 L = 210 mm  
 LB = 22 mm ▼  
 LL = 30 mm

**HSN 156-25**  
 L = 250 mm  
 LB = 29 mm ▼  
 LL = 40 mm

**HSN 157-30**  
 L = 300 mm  
 LB = 29 mm ▼  
 LL = 40 mm

doppelseitig  
double-ended  
 Chemikalienlöffel  
Spoons for chemicals



**HSN 160-17**  
 L = 170 mm  
 LB = 20 mm ▲  
 LL = 35 mm  
 LB = 12 mm ▼  
 LL = 30 mm  
 Apothekerlöffel, doppelendig  
Chemists spoon, double-ended



**HSN 159-15**  
 L = 150 mm  
 LB = 16 mm  
 LL = 32 mm  
 Apothekerlöffel  
Chemist's spoon



**HSN 161-16**  
 L = 160 mm  
 LB = 30 mm ▲  
 LL = 45 mm  
 LB = 22 mm ▼  
 LL = 35 mm  
 Löffel  
Spoon



**HSN 162-23**  
 L = 230 mm  
 LB = 38 mm ▲  
 LL = 75 mm  
 LB = 30 mm ▼  
 LL = 60 mm  
 Löffel  
Spoon



**HSN 158-16**  
 L = 155 mm  
 Chemikalienlöffel,  
Dm. 20 mm,  
Inhalt: 2 ml  
Spoons for chemicals,  
dia. 20 mm,  
content: 2 ml

**Zeichenerklärung**  
*Explication of abbreviations**L = Gesamtlänge*  
*L = Length overall**SB = Spatelbreite*  
*SB = Width of spatula**SL = Spatellänge*  
*SL = Length of spatula**LB = Löffelbreite*  
*LB = Width of spoon**LL = Löffellänge*  
*LL = Length of spoon***HSN 167-15**  
L = 150 mm  
LB = 17 mm  
LL = 35 mm  
Ø = 5,0 mm**HSN 168-18**  
L = 180 mm  
LB = 17 mm  
LL = 35 mm  
Ø = 5,0 mm**HSN 169-21**  
L = 210 mm  
LB = 17 mm  
LL = 35 mm  
Ø = 5,0 mm**HSN 170-25**  
L = 250 mm  
LB = 17 mm  
LL = 35 mm  
Ø = 5,0 mm**HSN 171-30**  
L = 300 mm  
LB = 17 mm  
LL = 35 mm  
Ø = 5,0 mm  
Polylöffel  
Poly spoons**HSN 173-21**  
L = 210 mm  
LB = 30 mm  
LL = 60 mm  
Ø = 8,0 mm**HSN 174-25**  
L = 250 mm  
LB = 30 mm  
LL = 60 mm  
Ø = 8,0 mm**HSN 175-30**  
L = 300 mm  
LB = 30 mm  
LL = 60 mm  
Ø = 8,0 mm**HSN 176-40**  
L = 400 mm  
LB = 30 mm  
LL = 60 mm  
Ø = 8,0 mm  
Polylöffel  
Poly spoons**HSN 179-19**  
L = 190 mm  
LB = 20 mm  
LL = 27 mm  
Polylöffel, mit Hohlgriff  
Poly spoon, with hollow handle**HSN 180-15**  
L = 150 mm  
LB = 17 mm  
LL = 35 mm**HSN 180-18**  
L = 180 mm  
LB = 17 mm  
LL = 35 mm  
Polylöffel für Linkshänder  
Poly spoon for lefthanders**HSN 403-12**  
L = 120 mm  
SB = 20 mm LB = 23 mm  
SL = 30 mm LL = 31 mm**HSN 404-15**  
L = 150 mm  
SB = 22 mm LB = 26 mm  
SL = 32 mm LL = 36 mm**HSN 405-18**  
L = 180 mm  
SB = 26 mm LB = 28 mm  
SL = 36 mm LL = 40 mm**HSN 406-21**  
L = 210 mm  
SB = 26 mm LB = 28 mm  
SL = 36 mm LL = 40 mm**HSN 407-25**  
L = 250 mm  
SB = 32 mm LB = 35 mm  
SL = 45 mm LL = 50 mm**HSN 408-30**  
L = 300 mm  
SB = 40 mm LB = 41 mm  
SL = 50 mm LL = 55 mm  
Löffelspatel  
Spoon spatulas

**Zeichenerklärung**  
**Explication of abbreviations**

L = Gesamtlänge      SB = Spatelbreite      SL = Spatellänge      LB = Löffelbreite      LL = Löffellänge  
L = Length overall      SB = Width of spatula      SL = Length of spatula      LB = Width of spoon      LL = Length of spoon



**HSN 410-20**  
L = 200 mm  
LB = 21 mm  
LL = 30 mm  
Offener Löffel  
Spoon, front open



**HSN 411-17**  
L = 175 mm  
Offener Löffel,  
(40 x 12 mm)  
Spoon, front open,  
(40 x 12 mm)



**HSN 412-17**  
L = 170 mm  
LB = 10 mm  
LL = 40 mm  
Wägeschäufelchen  
Weighing scoop



**HSN 424-10**  
L = 100 mm  
SB = 7 mm    LB = 7 mm  
SL = 30 mm    LL = 10 mm

**HSN 425-15**  
L = 150 mm  
SB = 7 mm    LB = 7 mm  
SL = 45 mm    LL = 10 mm

**HSN 426-18**  
L = 185 mm  
SB = 7 mm    LB = 7 mm  
SL = 50 mm    LL = 10 mm

**HSN 427-21**  
L = 210 mm  
SB = 7 mm    LB = 7 mm  
SL = 55 mm    LL = 10 mm  
Mikrolöffel spatula  
Micro spoon spatulas



**HSN 459-19**  
L = 190 mm  
LB = 35 mm  
LL = 70 mm  
Abfüllschaufel mit Knopf  
Weighing shovel with knob



Teflonbeschichtet  
Teflon-coated

**HSN 167-15T**    **HSN 169-21T**  
L = 150 mm      L = 210 mm  
LB = 17 mm      LB = 17 mm  
LL = 35 mm      LL = 35 mm  
Ø = 5,0 mm      Ø = 5,0 mm

**HSN 168-18T**  
L = 180 mm  
LB = 17 mm  
LL = 35 mm  
Ø = 5,0 mm  
Polylöffel, teflonbeschichtet  
Poly spoon, teflon-coated



**HSB 500-09**  
90 mm  
Mikroschere, gerade,  
Schnittlänge 10 mm  
Micro scissors, straight,  
cutting length 10 mm



**HSB 504-10**  
105 mm  
Mikroschere, gerade,  
Schnittlänge 15 mm  
Micro scissors, straight,  
cutting length 15 mm



**HSB 515-09**  
90 mm  
Mikroschere, kniegebogen,  
Schnittlänge 7 mm  
Micro scissors, angular,  
cutting length 7 mm



**HSB 516-09**  
105 mm  
Mikroschere, gerade,  
Schnittlänge 6 mm  
Micro scissors, straight,  
cutting length 6 mm



**HSB 520-12**  
**Noyes**  
120 mm  
Mikroschere, gerade,  
Schnittlänge 15 mm  
Micro scissors, straight,  
cutting length 15 mm



**HSB 530-08**  
**Modell Tübingen**  
85 mm  
Mikroschere, gerade,  
Schnittlänge 7 mm  
Micro scissors, straight,  
cutting length 7 mm



**HSB 531-08**  
**Modell Tübingen**  
85 mm  
Mikroschere, gebogen,  
Schnittlänge 7 mm  
Micro scissors, curved,  
cutting length 7 mm



**HSB 534-08**  
**Vannas**  
80 mm  
Mikroschere, gerade,  
Schnittlänge 5 mm  
Micro scissors, straight,  
cutting length 5 mm



**HSB 535-08**  
**Vannas**  
80 mm  
Mikroschere, gebogen,  
Schnittlänge 5 mm  
Micro scissors, curved,  
cutting length 5 mm

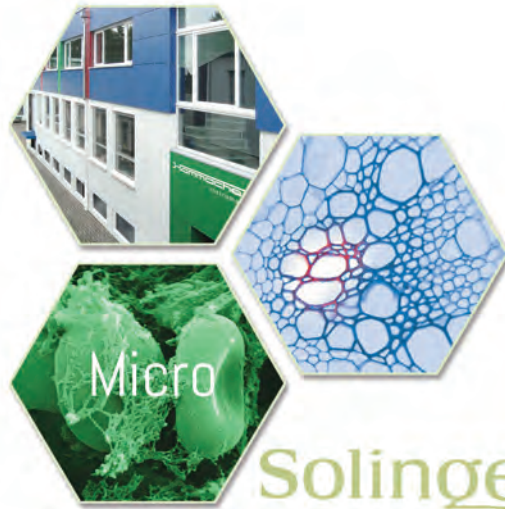

Solingen

**HSB 544-09**  
**Micro-Iris**90 mm  
Feine Präparierscheren, gerade  
Delicate dissecting scissors, straight**HSB 545-09**  
**Micro-Iris**90 mm  
Feine Präparierscheren, gebogen  
Delicate dissecting scissors, curved**HSB 546-11**110 mm / 4 1/4 inch  
sterilisierbar / sterilizable  
Mikroschere, gerade  
Micro scissors, straight**HSB 547-11**110 mm / 4 1/4 inch  
sterilisierbar / sterilizable  
Mikroschere, gebogen  
Micro scissors, curved

**L-HSB 554-14**

140 mm / 5 5/8 inch  
sterilisierbar / sterilizable  
Mikroschere, gerade  
Micro scissors, straight

**L-HSB 555-14**

140 mm / 5 5/8 inch  
sterilisierbar / sterilizable  
Mikroschere, gebogen  
Micro scissors, curved

**L-HSB 556-18**

180 mm / 7 1/16 inch  
Mikro-Gewebescherer, gerade  
Micro tissue scissors, straight

**L-HSB 557-18**

180 mm / 7 1/16 inch  
Mikro-Gewebescherer, gebogen  
Micro tissue scissors, curved

spitz - spitz  
sharp - sharp

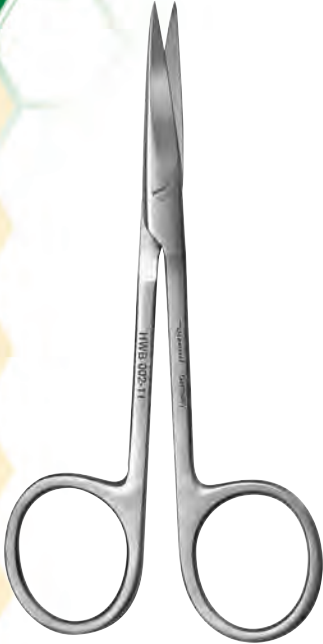

**HWB 002-11**  
110 mm  
gerade  
straight  
Mikro-Präparierscheren  
Micro dissecting scissors

spitz - spitz  
sharp - sharp



**HWB 003-11**  
110 mm  
leicht gebogen  
light curved  
Mikro-Präparierscheren  
Micro dissecting scissors

spitz - spitz  
sharp - sharp



**HWB 005-11**  
110 mm  
stark gebogen  
full curved  
Mikro-Präparierscheren  
Micro dissecting scissors

spitz - stumpf  
sharp - blunt



**HWB 010-11**  
110 mm  
Faden- und Gefäßschere, gerade  
Ligature and artery scissors, straight

spitz - spitz  
sharp - sharp

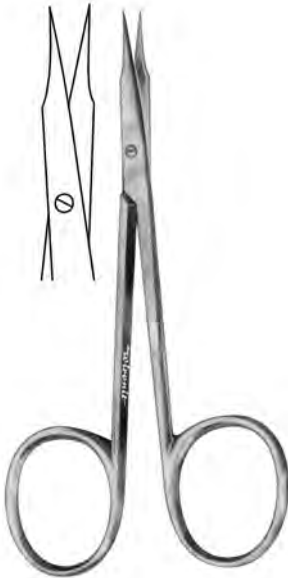

**HWB 022-11**  
**Stevens**  
110 mm  
Besonders feine Präparierscheren, gerade  
Very delicate scissors for dissecting, straight

spitz - stumpf  
sharp - blunt



**HWB 040-13**  
130 mm

**HWB 042-14**  
145 mm

**HWB 044-16**  
160 mm  
Schere für Physiologie, gerade  
Scissors for physiology, straight

spitz - stumpf  
sharp - blunt



**HWB 041-13**  
130 mm

**HWB 043-14**  
145 mm

**HWB 045-16**  
160 mm  
Schere für Physiologie, gebogen  
Scissors for physiology, curved

spitz - spitz  
sharp - sharp



**HWB 050-13**  
130 mm

**HWB 052-14**  
145 mm

**HWB 054-16**  
160 mm  
Schere für Physiologie, gerade  
Scissors for physiology, straight



*spitz - spitz  
sharp - sharp*

**HSB 006-10**

110 mm  
Scheren für Mikroskopie, gerade  
Microscopic scissors, straight



*spitz - spitz  
sharp - sharp*

**HSB 007-10**

110 mm  
Scheren für Mikroskopie, gebogen  
Microscopic scissors, curved

**HSB 004-09**  
**Gradle**

95 mm / 3 3/4 inch  
Scheren für Mikroskopie, sehr fein, gebogen  
Scissors for microscopy, very delicate, curved

**HSB 005-09**  
**Gradle**

95 mm / 3 3/4 inch  
Scheren für Mikroskopie, sehr fein, gebogen, Turmspitze  
Scissors for microscopy, very delicate, curved, tower pointed



*spitz - spitz  
sharp - sharp*

**HSB 008-13**

130 mm  
Scheren, gerade  
Scissors, straight



*spitz - spitz  
sharp - sharp*

**L-HSB 010-10**  
105 mm

**HSB 012-11**  
115 mm  
Scheren für Mikroskopie, gerade,  
Ausführung mit kantigem Scherenhalm  
Microscopic scissors, straight,  
execution with angular handles



*spitz - spitz  
sharp - sharp*

**L-HSB 011-10**  
105 mm

**HSB 013-11**  
115 mm  
Scheren für Mikroskopie, gebogen,  
Ausführung mit kantigem Scherenhalm  
Microscopic scissors, curved,  
execution with angular handles



*spitz - spitz  
sharp - sharp*

**L-HSB 014-11**  
115 mm

Scheren für Mikroskopie, gerade,  
Ausführung mit rundem Scherenhalm  
Microscopic scissors, straight,  
execution with round handles



*spitz - spitz  
sharp - sharp*

**L-HSB 015-11**  
115 mm

Scheren für Mikroskopie, gebogen,  
Ausführung mit rundem Scherenhalm  
Microscopic scissors, curved,  
execution with round handles



*spitz - spitz  
sharp - sharp*

**L-HSB 019-11**

115 mm  
Scheren für Mikroskopie, abgewinkelt,  
mit großen Grifferringen  
Microscopic scissors, angled,  
with big grip rings



*spitz - spitz  
sharp - sharp*

**L-HSB 020-11**

115 mm  
Präparierschere, sehr fein,  
mit großen Grifferringen  
Dissecting scissors, very delicate,  
with big grip rings



**HSB 018-11**

115 mm  
Folienschere, gerade, mit feiner Zahnung  
Foil scissors, straight, with micro serration



*spitz - spitz  
sharp - sharp*

**L-HSB 021-11**

115 mm  
Präparierschere, gebogen, sehr fein,  
mit großen Grifferringen  
Dissecting scissors, curved, very delicate,  
with big grip rings



*spitz - spitz  
sharp - sharp*

**L-HSB 022-12  
Wagner**

120 mm  
Präparierschere, gerade  
Dissecting scissors, straight



*spitz - spitz  
sharp - sharp*

**L-HSB 023-12  
Wagner**

120 mm  
Präparierschere, gebogen  
Dissecting scissors, curved



*spitz - spitz  
sharp - sharp*

**L-HSB 028-15  
Joseph**

140 mm  
Präparierschere, gerade  
Dissecting scissors, straight



*spitz - spitz  
sharp - sharp*

**L-HSB 029-15  
Joseph**

140 mm  
Präparierschere, gebogen  
Dissecting scissors, curved



*spitz - spitz  
sharp - sharp*

**L-HSB 030-16  
Kelly**

160 mm  
Präparierschere, gerade  
Dissecting scissors, straight



*spitz - spitz  
sharp - sharp*

**L-HSB 031-16  
Kelly**

160 mm  
Präparierschere, gebogen  
Dissecting scissors, curved

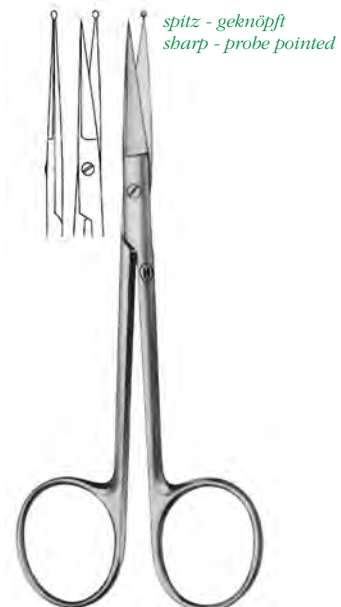

*spitz - geknöpft  
sharp - probe pointed*

**HSB 033-16  
Kelly**

160 mm  
gezahnt, gebogen  
sawedge, curved

**L-HSB 046-11**

115 mm  
Präparierschere, fein, mit Knopf  
Dissecting scissors, delicate, with knob



*spitz - spitz  
sbarp - sbarp*

**L-HSB 047-11**  
**La Grange**

115 mm  
Präparierschere, doppelt gebogen, gezahnt  
Dissecting scissors, double curved, sawged



**L-HSB 048-13**  
**Goldman-Fox**

130 mm  
Präparierschere gezahnt, gerade  
Dissecting scissors sawged, straight



Solingen

*Für Linkshänder*  
*For left-handers*



**L-HSB 049-13**  
**Goldman-Fox**

130 mm  
Präparierschere gezahnt, gebogen  
Dissecting scissors sawged, curved



**HSB 051-13**  
**Goldman-Fox mod.**

130 mm  
Präparierschere gezahnt, gebogen  
Dissecting scissors sawged, curved



*spitz - spitz  
sbarp - sbarp*

**HSB 614-11**  
115 mm  
Schere, gerade,  
für Linkshänder  
Scissors, straight,  
for left-handers



*spitz - spitz  
sbarp - sbarp*

**HSB 615-11**  
115 mm  
Schere, gebogen,  
für Linkshänder  
Scissors, curved,  
for left-handers



*stumpf - stumpf  
blunt - blunt*

**L-HSB 070-11**  
Standard  
115 mm

**L-HSB 072-13**  
Standard  
130 mm

**L-HSB 074-14**  
Standard  
145 mm

**L-HSB 076-15**  
Standard  
155 mm

**L-HSB 078-16**  
Standard  
165 mm

**L-HSB 080-18**  
Standard  
185 mm  
Schere, gerade  
Scissors, straight

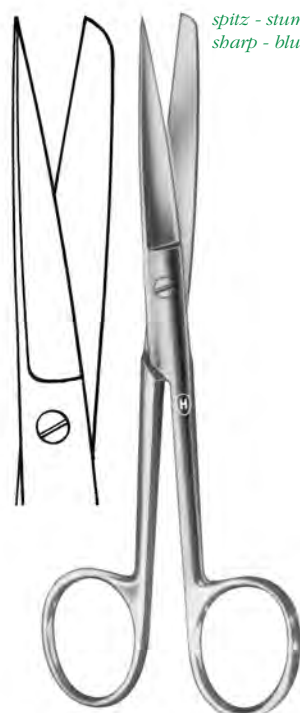

*spitz - stumpf  
sharp - blunt*

**L-HSB 084-11**  
Standard  
115 mm

**L-HSB 086-13**  
Standard  
130 mm

**L-HSB 088-14**  
Standard  
145 mm

**L-HSB 090-15**  
Standard  
155 mm

**L-HSB 092-16**  
Standard  
165 mm

**L-HSB 094-18**  
Standard  
185 mm  
Schere, gerade  
Scissors, straight

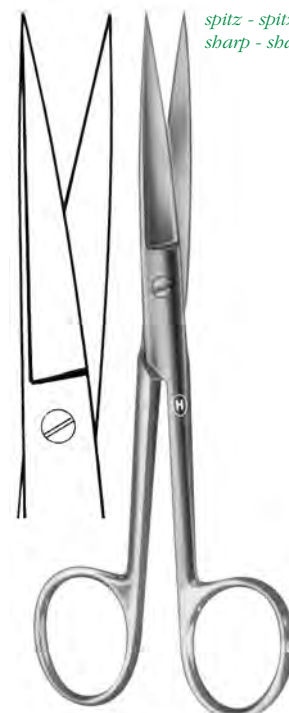

*spitz - spitz  
sharp - sharp*

**L-HSB 098-11**  
Standard  
115 mm

**L-HSB 100-13**  
Standard  
130 mm

**L-HSB 102-14**  
Standard  
145 mm

**L-HSB 104-15**  
Standard  
155 mm

**L-HSB 106-16**  
Standard  
165 mm

**L-HSB 108-18**  
Standard  
185 mm  
Schere, gerade  
Scissors, straight

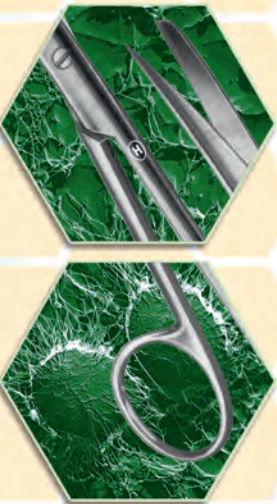

Solingen



*stumpf - stumpf  
blunt - blunt*

**HSB 071-11**  
Standard  
115 mm

**HSB 073-13**  
Standard  
130 mm

**HSB 075-14**  
Standard  
145 mm

**HSB 077-15**  
Standard  
155 mm

**HSB 079-16**  
Standard  
165 mm

**HSB 081-18**  
Standard  
185 mm  
Schere, gebogen  
Scissors, curved



*spitz - stumpf  
sharp - blunt*

**HSB 085-11**  
Standard  
115 mm

**HSB 087-13**  
Standard  
130 mm

**HSB 089-14**  
Standard  
145 mm

**HSB 091-15**  
Standard  
155 mm

**HSB 093-16**  
Standard  
165 mm

**HSB 095-18**  
Standard  
185 mm  
Schere, gebogen  
Scissors, curved



*spitz - spitz  
sharp - sharp*

**HSB 099-11**  
Standard  
115 mm

**HSB 101-13**  
Standard  
130 mm

**HSB 103-14**  
Standard  
145 mm

**HSB 105-15**  
Standard  
155 mm

**HSB 107-16**  
Standard  
165 mm

**HSB 109-18**  
Standard  
185 mm  
Schere, gebogen  
Scissors, curved



*stumpf - stumpf  
blunt - blunt*

**HSB 113-12  
Kilner/Ragnell**  
120 mm  
Präparierschere, fein, gebogen  
Dissecting scissors, fine, curved

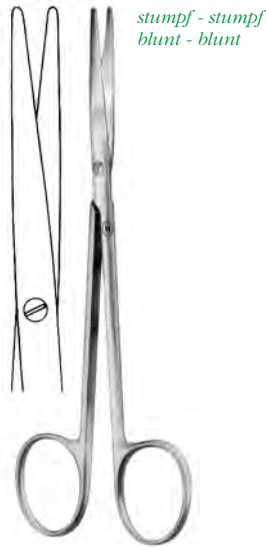

*stumpf - stumpf  
blunt - blunt*

**L-HSB 120-14  
Baby-Metzenbaum**  
145 mm

**HSB 124-18  
Baby-Metzenbaum**  
180 mm  
Präparierschere, fein,  
gerade, stumpf-stumpf  
Dissecting scissors, fine,  
straight, blunt-blunt

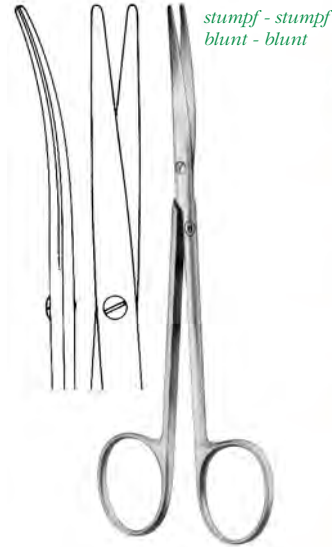

*stumpf - stumpf  
blunt - blunt*

**L-HSB 121-14  
Baby-Metzenbaum**  
145 mm

**HSB 125-18  
Baby-Metzenbaum**  
180 mm  
Präparierschere, fein,  
gebogen, stumpf-stumpf  
Dissecting scissors, fine,  
curved, blunt-blunt

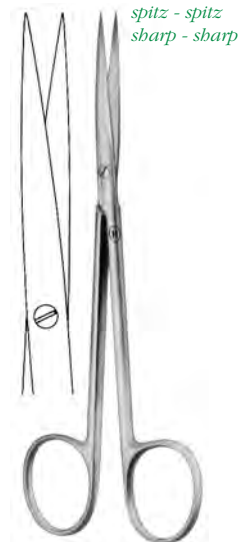

*spitz - spitz  
sharp - sharp*

**L-HSB 126-14  
Metzenbaum fino**  
145 mm

**L-HSB 128-18  
Metzenbaum fino**  
180 mm  
Besonders feine Präparier- und  
Nahtschere, gerade, spitz-spitz  
Very delicate scissors for dissecting  
and suture, straight, sharp-sharp

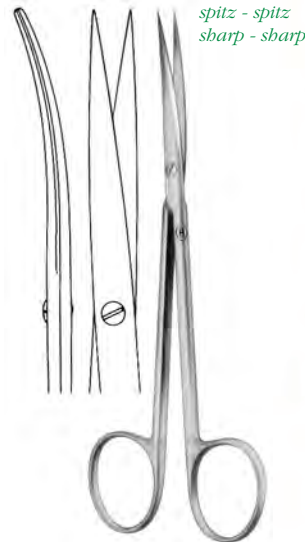

*spitz - spitz  
sharp - sharp*

**L-HSB 127-14  
Metzenbaum fino**  
145 mm

**HSB 129-18  
Metzenbaum fino**  
180 mm  
Besonders feine Präparier- und  
Nahtschere, gebogen, spitz-spitz  
Very delicate scissors for dissecting  
and suture, curved, sharp-sharp

*spitz - spitz  
sharp - sharp*

**HSK 650-23**  
230 mm  
Knochenschere, gerade  
Bone shears, straight



**L-HSB 284-09**  
**Spencer**  
90 mm  
Nahtschere, gerade  
Suture scissors, straight

*stumpf - stumpf  
blunt - blunt*

**HSB 064-14**  
**Mayo**  
145 mm

**HSB 068-17**  
**Mayo**  
170 mm  
Schere, gerade  
Scissors, straight

*stumpf - stumpf  
blunt - blunt*

**HSB 065-14**  
**Mayo**  
145 mm

**HSB 069-17**  
**Mayo**  
170 mm  
Schere, gebogen,  
Scissors, curved,

*spitz - geknöpft  
sharp - probe pointed*

**HSB 138-14**  
145 mm  
Inzisionsschere, geknöpft  
Incision scissors, probe pointed



**L-HSB 287-11**  
**Spencer**  
115 mm  
Nahtschere, abgewinkelt  
Suture scissors, angled



Scheren mit Hartmetalleinlagen haben eine lange gleichmäßige Schnitthaltigkeit. Sie haben zur Kennzeichnung vergoldete Griffe.  
Scissors with tungsten carbide inserts have a uniform long lasting cut. They are identified by gold-plated handles.



*spitz - spitz  
scharf - scharf*

**L-HSB 300-11**

115 mm  
Präparierschere, gerade  
Dissecting scissors, straight



*spitz - spitz  
scharf - scharf*

**L-HSB 301-11**

115 mm  
Präparierschere, gebogen  
Dissecting scissors, curved



*stumpf - stumpf  
blunt - blunt*

**HSB 306-14  
Standard**

145 mm  
Chirurgische Schere  
Operating scissors



*spitz - stumpf  
scharf - blunt*

**L-HSB 310-14  
Standard**

145 mm  
Chirurgische Schere  
Operating scissors



*spitz - spitz  
scharf - scharf*

**HSB 314-14  
Standard**

145 mm  
Chirurgische Schere, gerade  
Operating scissors, straight



*spitz - spitz  
scharf - scharf*

**HSB 316-14  
Metzenbaum fino**

145 mm  
Feine Präparierschere, gerade  
Delicate dissecting scissors, straight



*spitz - spitz  
scharf - scharf*

**HSB 317-14  
Metzenbaum fino**

145 mm  
Feine Präparierschere, gebogen  
Delicate dissecting scissors, curved



*stumpf - stumpf  
blunt - blunt*

**HSB 324-14  
Metzenbaum fino**

145 mm  
Feine Präparierschere, gerade  
Delicate dissecting scissors, straight



*stumpf - stumpf  
blunt - blunt*

**HSB 325-14  
Metzenbaum fino**

145 mm  
Feine Präparierschere, gebogen  
Delicate dissecting scissors, curved



*spitz - spitz  
sharp - sharp*

**L-HSB 390-10**  
105 mm  
Präparierschere, gerade  
Dissecting scissors, straight



*spitz - spitz  
sharp - sharp*

**L-HSB 391-10**  
105 mm  
Präparierschere, gebogen  
Dissecting scissors, curved



*spitz - spitz  
sharp - sharp*

**HSB 393-11**  
115 mm  
Präparierschere, abgewinkelt  
Dissecting scissors, angled



*spitz - spitz  
sharp - sharp*

**HSB 395-13  
Goldman-Fox**  
130 mm  
Präparierschere, gebogen  
Dissecting scissors, curved



## SUPER-CUT

## Scheren

- ✓ Mit Mikroschliff
- ✓ Die Extrascharfe für jeden Bereich in Klinik und Praxis.

## Scissors

- ✓ With micro section
- ✓ Extra sharp for all surgical uses in the hospital and the private practice



**L-HSB 392-11  
La Grange**  
115 mm  
Präparierschere, S-förmig gebogen  
Dissecting scissors, curved in an S shape



*spitz - stumpf  
sharp - blunt*

**HSB 396-13  
Standard Grazil**  
130 mm  
Präparierschere, gerade  
Dissecting scissors, straight



*spitz - stumpf  
sharp - blunt*

**HSB 397-13  
Standard Grazil**  
130 mm  
Präparierschere, gebogen  
Dissecting scissors, curved

aus rostfreiem Stahl  
from stainless steel*spitz - spitz  
sharp - sharp***L-HSB 400-14  
Joseph**  
140 mm  
Präparierschere, gerade  
Dissecting scissors, straight*spitz - spitz  
sharp - sharp***L-HSB 401-14  
Joseph**  
140 mm  
Präparierschere, gebogen  
Dissecting scissors, curved**L-HSB 0140-11**  
115 mm  
Präparierschere, gerade,  
mit großen Griffingen  
Dissecting scissors, straight,  
with big grip rings**L-HSB 0141-11**  
115 mm  
Präparierschere, gebogen,  
mit großen Griffingen  
Dissecting scissors, curved,  
with big grip rings*spitz - spitz  
sharp - sharp***L-HSB 402-16  
Kelly**  
160 mm  
Präparierschere, gerade  
Dissecting scissors, straight*spitz - spitz  
sharp - sharp***L-HSB 403-16  
Kelly**  
160 mm  
Präparierschere, gebogen  
Dissecting scissors, curved*spitz - stumpf  
sharp - blunt***L-HSB 412-13  
Standard**  
130 mm  
Präparierschere, gerade  
Dissecting scissors, straight*spitz - spitz  
sharp - sharp***L-HSB 422-13  
Standard**  
130 mm  
Präparierschere, gerade  
Dissecting scissors, straight*spitz - spitz  
sharp - sharp***L-HSB 423-13  
Standard**  
130 mm  
Präparierschere, gebogen  
Dissecting scissors, curved



**HSB 596-20**  
200 mm  
Arbeitsschere, rostfrei  
Laboratory scissors, stainless



**HSB 581-11**  
**Lister**  
115 mm

**HSB 583-14**  
**Lister**  
145 mm

**HSB 585-18**  
**Lister**  
180 mm  
Laborschere, abgewinkelt  
Laboratory scissors, angular



**HSB 593-15**  
150 mm  
Laborschere  
Laboratory scissors



**HSB 601-18**  
**Universal**  
180 mm  
Universalschere  
Universal scissors



**HSB 595-13**  
130 mm  
Laborschere  
Laboratory scissors



**HSB 602-14**  
145 mm  
Laborschere, gerade  
Laboratory scissors, straight



**HSB 591-13**  
130 mm  
Laborschere  
Laboratory scissors



**HSB 050-00**  
200 mm  
Multifunktionsschere  
Multifunctional scissors



**HSB 051-20**  
200 mm  
Laborschere  
Laboratory scissors



**HSB 579-21**  
210 mm  
Allzweckschere, selbstöffnend, universell einsetzbar  
leicht zu bedienen durch Einhandverschluss  
All-purpose scissors, self-opening, universally  
applicable, easy to handle by one-hand lock system



**HSB 597-13**  
130 mm  
Laborschere  
Laboratory scissors



**HSB 589-18**  
180 mm  
Drahtschere, mit spitzer stabiler Schneide für exaktes Schneiden;  
mit Drahtkerbe und großen Griffen für ein bequemes Arbeiten  
Wire scissors, with a sharp, stable cutting edge for precise cutting;  
with wire notch and large handles for comfortable working

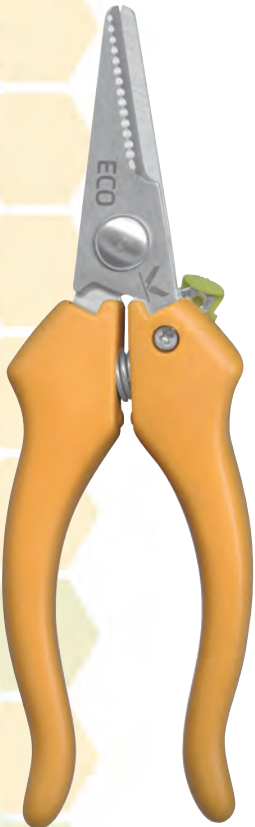

**HSL 516-14**  
145 mm  
Blech- und Drahtschere  
Plate and wire shear

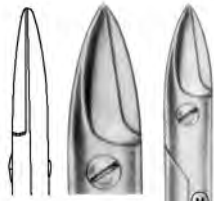

**HSB 648-10**  
**Beebee**  
100 mm  
Blech- und Drahtschere, gerade  
Plate and wire shear, straight

**HSB 650-10**  
**Beebee**  
100 mm  
gezahnt, gerade  
saw edge, straight

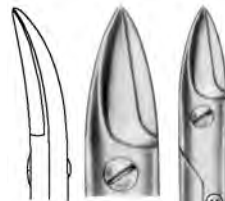

**HSB 649-10**  
**Beebee**  
100 mm  
Blech- und Drahtschere, gebogen  
Plate and wire shear, curved

**HSB 651-10**  
**Beebee**  
100 mm  
gezahnt, gebogen  
saw edge, curved



**HSB 653-10**  
**Spezial**  
100 mm  
Blech- und Drahtschere, gebogen  
Plate and wire shear, curved



**HSB 664-11**  
115 mm  
Blech- und Drahtschere, gerade  
Plate and wire shear, straight



**HSB 665-11**  
115 mm  
gebogen  
curved



**HSL 510-17**  
170 mm  
Blech- und Drahtschere, gerade  
Plate and wire shear, straight



**HSL 512-17**  
170 mm  
gebogen  
curved

**HSB 659-12**  
**Universal**  
120 mm  
Blech- und Drahtschere, gezahnt  
Plate and wire shear, saw edge



*spitz - spitz  
sharp - sharp*

**HSB 942-09**  
90 mm

**HSB 942-11**  
115 mm

**HSB 942-13**  
130 mm  
Scheren für Mikroskopie, gerade  
Microscopic scissors, straight



*spitz - spitz  
sharp - sharp*

**HSB 943-09**  
90 mm

**HSB 943-11**  
115 mm

**HSB 943-13**  
130 mm  
Scheren für Mikroskopie, gebogen  
Microscopic scissors, curved



*spitz - spitz  
sharp - sharp*

**HSB 945-11**  
115 mm  
Scheren für Mikroskopie, abgewinkelt  
Microscopic scissors, angled



*spitz - spitz  
sharp - sharp*

**HSB 954-14**  
140 mm  
Scheren, gerade  
Scissors, straight



*spitz - geknöpft  
sharp - probe pointed*

**HSB 946-14**  
145 mm  
Inzisionsschere, geknöpft  
Incision scissors, probe pointed

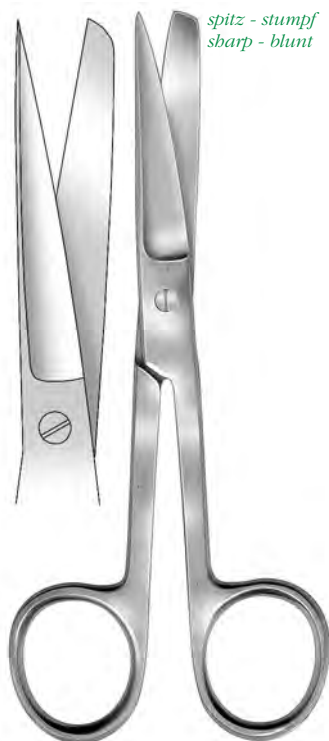

*spitz - stumpf  
sharp - blunt*

**HSB 948-13  
Standard**  
130 mm

**HSB 948-14  
Standard**  
145 mm  
Scheren, gerade  
Scissors, straight



*stumpf - stumpf  
blunt - blunt*

**HSB 950-12**  
120 mm  
Taschenschere  
Pocket scissors



*spitz - stumpf  
sharp - blunt*

**HSB 952-12**  
125 mm

**HSB 952-16**  
160 mm  
Arbeitsschere  
Laboratory scissors



**L-HSC 250-17**  
175 mm / 7 inch  
**Gerald**  
gerade  
straight



**L-HSC 251-17**  
175 mm / 7 inch  
**Gerald**  
gebogen  
curved



**L-HSC 252-17**  
175 mm / 7 inch  
**Gerald**  
gerade  
straight



**L-HSC 253-17**  
175 mm / 7 inch  
**Gerald**  
gebogen  
curved



**HWC 088-10**  
105 mm  
Schneidende Pinzette  
Forceps with cutting tips



**HWC 110-10**  
105 mm  
No. 4  
Mikro-Präparierpinzette,  
sehr fein, gerade  
Micro preparation forceps,  
very delicates, straight



**HWC 111-10**  
105 mm  
Mikro-Präparierpinzette,  
sehr fein, gebogen  
Micro preparation forceps,  
very delicates, curved



**HWC 112-10**  
105 mm  
Mikro-Präparierpinzette,  
sehr fein, gewinkelt  
Micro preparation forceps,  
very delicates, angled



**HWC 115-10**  
105 mm  
No. 7  
Mikro-Präparierpinzette,  
sehr fein, gebogen  
Micro preparation forceps,  
very delicates, curved

**H***wironit*aus Wironit Stahl  
from Wironit steelMikropinzetten  
Micro forcepsPinzetten  
Forceps**5**

**HWC 200-10**  
105 mm  
Mikropinzetten, gerade  
Micro forceps, straight



**HWC 201-10**  
105 mm

**HWC 203-11**  
115 mm  
Mikropinzetten, gebogen  
Micro forceps, curved



**HWC 202-10**  
105 mm  
Mikropinzetten mit Stift, gerade,  
Micro forceps, with pin straight



**HWC 205-10**  
105 mm

**HWC 207-11**  
115 mm  
Mikropinzetten, mit Stift, gebogen  
Micro forceps, with pin, curved



**HWC 204-11**  
115 mm  
Mikropinzetten, gerade  
Micro forceps, straight



**HWC 206-11**  
115 mm  
Mikropinzetten mit Stift, gerade,  
Micro forceps, with pin straight

**H**  
*wironit*

**Wironit Instrumente sind aus einer Speziallegierung gefertigt und weisen folgende Vorteile auf:**

- ✓ nichtrostend
- ✓ antimagnetisch
- ✓ säurebeständig

Sie sind formschön, liegen leicht in der Hand und sind von langer Lebensdauer.

**H**  
*wironit*

**Wironit instruments are made of a special alloy and show the following advantages:**

- ✓ rust resistant
- ✓ anti-magnetic
- ✓ acid resistant

They are beautifully designed and of unlimited durability.

**49**



Wironit Instrumente sind aus einer Speziallegierung gefertigt und weisen folgende Vorteile auf:

- ✓ nichtrostend
- ✓ antimagnetisch
- ✓ säurebeständig

Sie sind formschön, liegen leicht in der Hand und sind von langer Lebensdauer.



Wironit instruments are made of a special alloy and show the following advantages:

- ✓ rust resistant
- ✓ anti-magnetic
- ✓ acid resistant

They are beautifully designed and of unlimited durability.



**HWC 210-10**  
105 mm  
Mikropinzetten, gerade  
Micro forceps, straight



**HWC 211-10**  
105 mm  
Mikropinzetten, gebogen  
Micro forceps, curved



**HWC 212-10**  
105 mm  
Mikropinzetten, mit Stift, gerade  
Micro forceps, with pin, straight



**HWC 216-11**  
115 mm  
Mikropinzetten, mit Stift, gerade  
Micro forceps, with pin, straight



**HWC 217-11**  
115 mm  
Mikropinzetten, mit Stift, gebogen  
Micro forceps, with pin, curved



**L-HSC 082-12**  
**Micro-Adson**  
120 mm  
Feine Pinzette  
Delicate forceps



**HSC 083-15**  
**Micro-Adson**  
150 mm  
Feine Pinzette  
Delicate forceps



**L-HSC 232-12**  
**Micro-Adson**  
120 mm  
Feine Pinzette  
Delicate forceps



**L-HSC 233-15**  
**Micro-Adson**  
150 mm  
Feine Pinzette  
Delicate forceps



**HWC 116-10**  
100 mm  
Leichtpinzette aus  
Uhrfederstahl, stumpf  
Light forceps of watch  
spring sheet-steel, blunt



**HWC 118-10**  
100 mm  
Leichtpinzette aus  
Uhrfederstahl, spitz  
Light forceps of watch  
spring sheet-steel, sharp

0,3 mm



**HSC 600-11**  
115 mm  
No. 3  
Mikropinzetten, gerade  
Micro forceps, straight

0,3 mm



**HSC 601-11**  
110 mm  
No. 5- 45  
Mikropinzetten, seitwärts abgewinkelt, 45°  
Micro forceps, laterally angled, 45°

0,4 mm



**HSC 602-11**  
110 mm  
No. 4  
Mikropinzetten, gerade  
Micro forceps, straight

0,2 mm



**HSC 603-11**  
115 mm  
No. 7  
Mikropinzetten, gebogen  
Micro forceps, curved

0,15 mm



**HSC 604-11**  
110 mm  
No. 5  
Mikropinzetten, gerade  
Micro forceps, straight

0,3 mm



**HSC 606-14**  
140 mm  
No. SS  
Mikropinzetten, antimagnetisch  
Micro forceps, antimagnetic

0,3 mm



**HSC 607-12**  
120 mm  
No. 1  
Mikropinzetten, antimagnetisch  
Micro forceps, antimagnetic

0,3 mm



**HSC 608-12**  
120 mm  
No. 4  
Mikropinzetten, antimagnetisch  
Micro forceps, antimagnetic

0,3 mm



**HSC 609-12**  
120 mm  
No. 7  
Mikropinzetten, antimagnetisch  
Micro forceps, antimagnetic



**HSC 614-12**  
120 mm  
Mikropinzette, feine  
Sichelform mit kurzer  
gerader Spitze,  
antimagnetisch  
Micro forceps, fine lunate  
shape, short straight tips,  
antimagnetic



**HSC 610-13**  
130 mm  
Mikropinzette, gerade,  
spitz, antimagnetisch  
Micro forceps, straight,  
pointed, antimagnetic



**HSC 615-12**  
120 mm  
Mikropinzette, mit  
feiner Sichelspitze,  
antimagnetisch  
Micro forceps, fine  
lunate tips,  
antimagnetic



**HSC 611-13**  
135 mm  
Mikropinzette, gerade,  
spitz, antimagnetisch  
Micro forceps, straight,  
pointed, antimagnetic



**HSC 616-12**  
120 mm  
Mikropinzette, mit  
feiner Hakenspitze,  
antimagnetisch  
Micro forceps, fine  
hooked tips,  
antimagnetic



**HSC 612-13**  
135 mm  
Mikropinzette, Spitze  
gebogen, antimagnetisch  
Micro forceps, tips short  
bent, antimagnetic

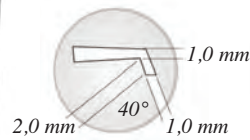

**HSC 617-12**  
120 mm  
Spezialpinzette  
Special forceps



**HSC 613-12**  
120 mm  
Mikropinzette, feine kurz  
gebogene Spitzen,  
antimagnetisch  
Micro forceps, fine tips  
short bent, antimagnetic

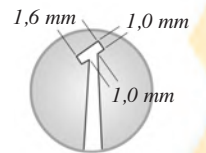

**HSC 618-12**  
120 mm  
Spezialpinzette  
Special forceps



**HWC 130-15**  
155 mm  
gerieft  
serrated



**L-HWC 016-04**  
150 mm  
glatt  
smooth



**L-HWC 017-05**  
150 mm  
gerieft  
serrated

Laborpinzette mit Führungsstift  
Laboratory forceps with guiding pin



**HWC 131-12**  
120 mm  
glatt, spitz  
smooth, sharp



**HWC 134-12**  
120 mm  
gerieft, stumpf  
serrated, blunt

**HWC 132-14**  
140 mm  
glatt, spitz  
smooth, sharp

**HWC 135-14**  
140 mm  
gerieft, stumpf  
serrated, blunt

**HWC 133-16**  
160 mm  
glatt, spitz  
smooth, sharp

**HWC 136-16**  
160 mm  
gerieft, stumpf  
serrated, blunt

Laborpinzetten  
Laboratory forceps



**HSC 048-10**  
Standard  
105 mm

**L-HSC 050-11**  
Standard  
115 mm

**L-HSC 052-13**  
Standard  
130 mm

**L-HSC 054-14**  
Standard  
145 mm

**L-HSC 056-16**  
Standard  
160 mm

**HSC 058-18**  
Standard  
180 mm

**HSC 060-20**  
Standard  
200 mm

**HSC 062-25**  
Standard  
250 mm

**HSC 064-30**  
Standard  
300 mm  
Laborpinzetten  
Laboratory forceps



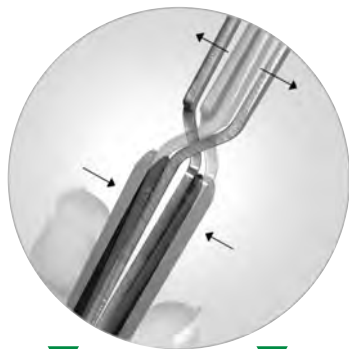

**HWC 144-16**  
160 mm  
gerade Spitze  
straight tip

**HWC 145-16**  
160 mm  
gebogene Spitze  
curved tip

Lötpinzetten  
Soldering tweezers



**HWC 147-10**  
105 mm



**HWC 148-16**  
160 mm  
Deckglaspinzetten  
Cover glass forceps



**HWC 149-16**  
160 mm



**L-HWC 050-12**  
Standard  
120 mm

**L-HWC 051-13**  
Standard  
130 mm

**L-HWC 052-14**  
Standard  
145 mm

**L-HWC 053-16**  
Standard  
160 mm

**L-HWC 054-18**  
Standard  
180 mm

**L-HWC 055-20**  
Standard  
200 mm

**L-HWC 056-25**  
Standard  
250 mm  
Laborpinzetten  
Laboratory forceps



**L-HWC 080-12**  
Standard  
120 mm

**L-HWC 081-13**  
Standard  
130 mm

**L-HWC 082-14**  
Standard  
145 mm

**L-HWC 083-16**  
Standard  
160 mm  
Laborpinzetten  
Laboratory forceps

*Elektronikpinzetten,  
antimagnetisch  
Electronic forceps,  
antimagnetica*

**HWC 533-14**145 mm  
gerade  
straightGreifpinzetten, flache Spitzen, 5 mm breit  
Grasping forceps, flat tips, 5 mm wide**HWC 538-12**120 mm  
gebogen,  
curved**L-HWC 070-10**

105 mm

**L-HWC 072-11**

115 mm

**L-HWC 074-13**130 mm  
gerade  
straight**L-HWC 071-10**

105 mm

**L-HWC 073-11**

115 mm

**L-HWC 075-13**130 mm  
gebogen  
curvedMikroskopische Pinzetten  
Microscopic forceps**HWC 102-09**  
90 mm**HWC 103-10**  
105 mm**HWC 104-11**  
115 mm  
Feine Präparierpinzetten  
Fine preparation forceps**L-HWC 019-12****Meriam**  
150 mm  
gerieft  
serrated**L-HWC 530-14**145 mm  
Greifpinzette,  
gebogen  
Grasping forceps,  
curved

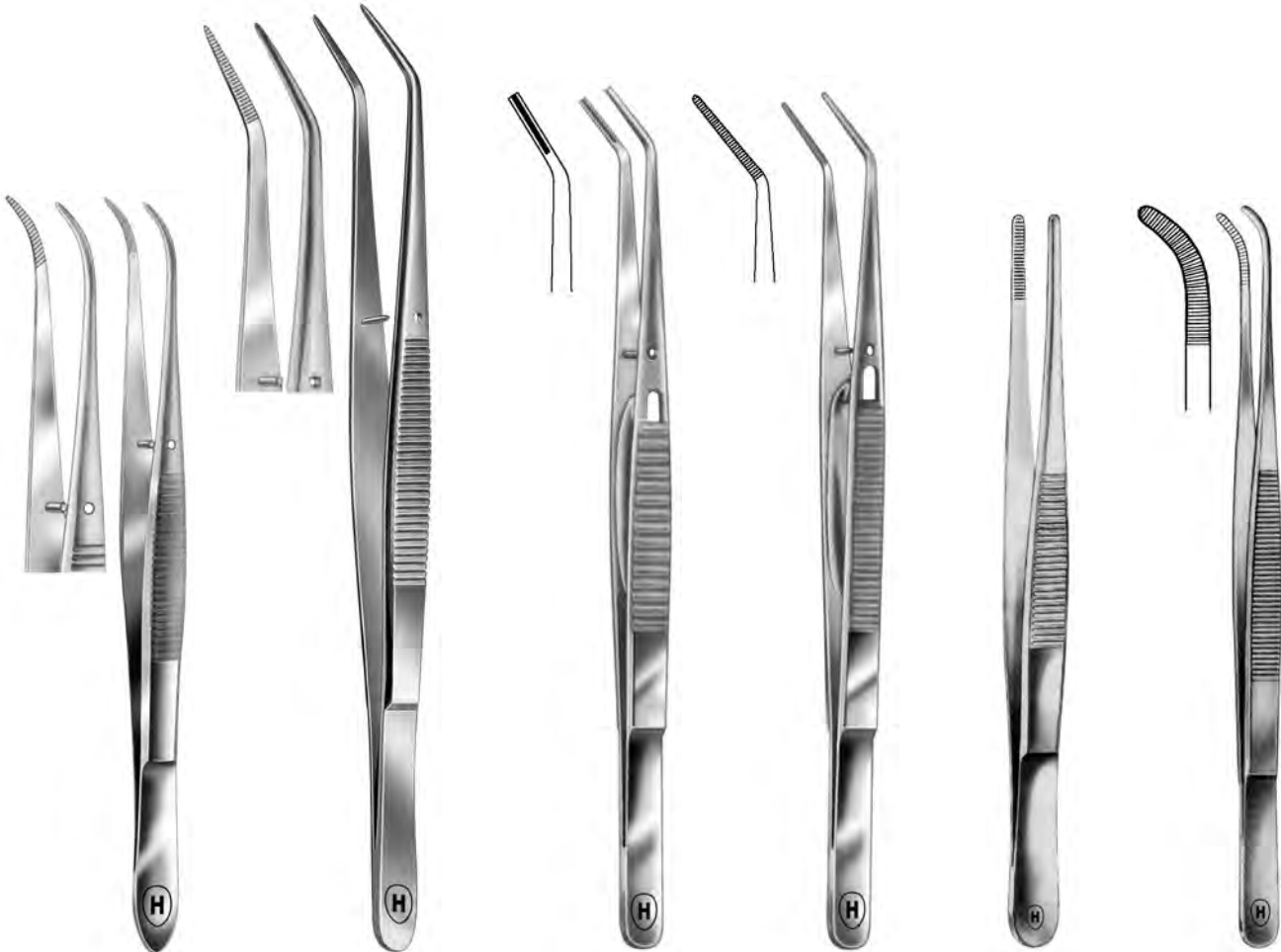
**HSC 001-01**

130 mm  
Färbepinzette, gerieft  
Staining forceps, serrated

**L-HSC 012-05**

160 mm  
Färbepinzette, gerieft  
Staining forceps, serrated

**HSC 030-15**

155 mm  
Nadelpinzette mit Schloß  
Needle forceps with lock

**L-HSC 031-15**

155 mm  
Färbepinzette mit  
Fixierschloß  
Staining forceps  
with spring catch

**HSC 072-13**

130 mm

**HSC 074-14**

145 mm  
Pinzetten, gerade,  
schlankes Modell  
Forceps, straight,  
delicate model

**HSC 073-13**

130 mm  
Pinzetten, gebogen,  
schlankes Modell  
Forceps, curved,  
delicate model



Solingen



**L-HSC 080-12**  
**Adson**  
120 mm  
Feine Pinzetten  
Delicate forceps



**L-HSC 081-15**  
**Adson**  
150 mm  
Feine Pinzetten  
Delicate forceps



**L-HSC 086-12**  
**Semken**  
120 mm

**L-HSC 088-15**  
**Semken**  
150 mm  
Feine Pinzetten, gerade  
Delicate forceps, straight



**L-HSC 087-12**  
**Semken**  
120 mm

**HSC 089-15**  
**Semken**  
150 mm  
Feine Pinzetten, gebogen  
Delicate forceps, curved



**L-HSC 128-15**  
**Waugh**  
150 mm

**L-HSC 129-20**  
**Waugh**  
200 mm  
Pinzetten, fein  
Forceps, delicate

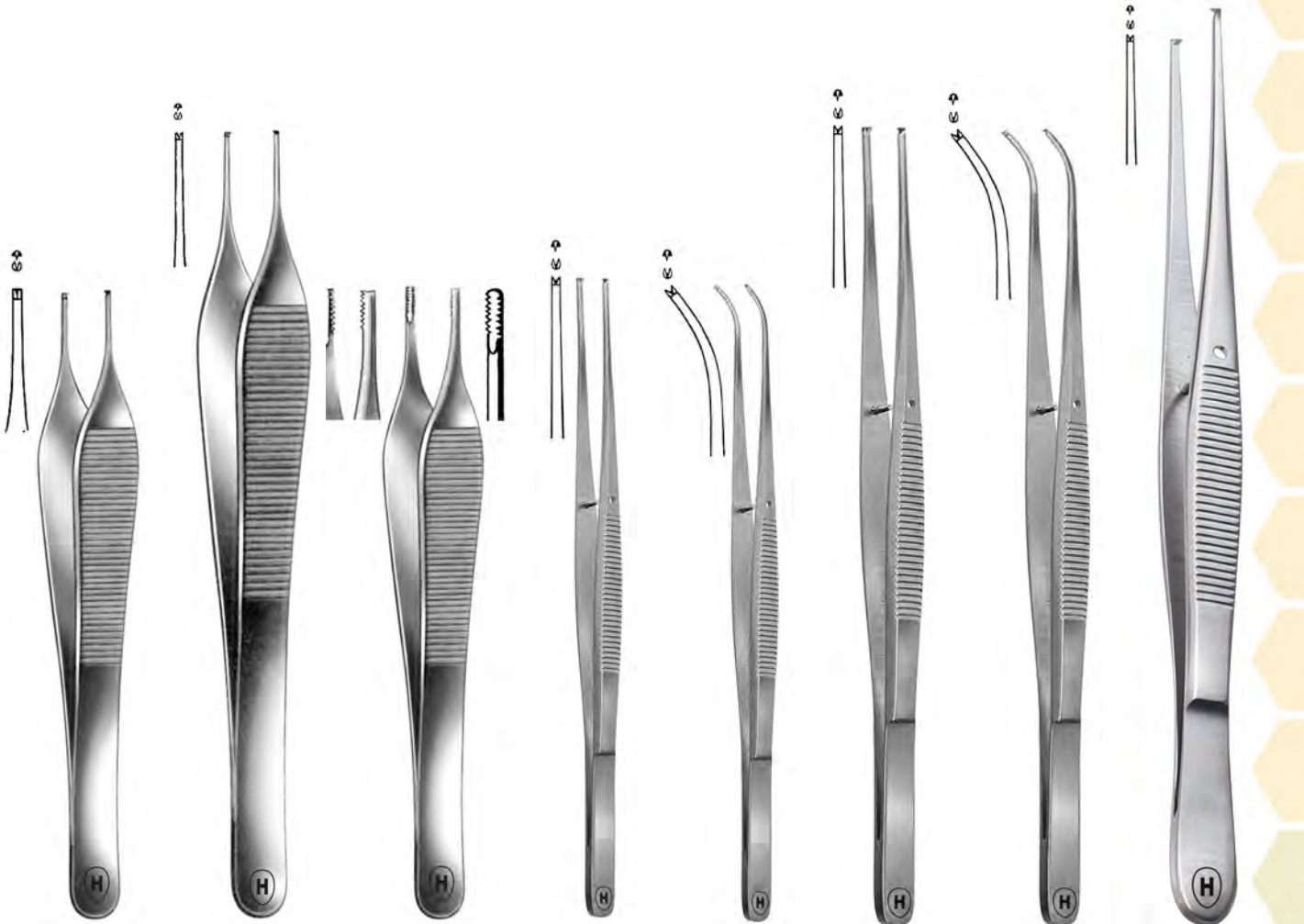

**L-HSC 230-12**  
**Adson**  
120 mm  
Feine Hakenpinzette  
Delicate tissue forceps

**L-HSC 231-15**  
**Adson**  
150 mm  
Feine Hakenpinzette  
Delicate Forceps

**L-HSC 234-12**  
**Adson-Brown**  
120 mm  
Feine Hakenpinzette  
Delicate tissue forceps

**L-HSC 238-12**  
**Semken**  
120 mm  
gerade  
straight  
Feine Hakenpinzette  
Delicate Forceps

**L-HSC 239-12**  
**Semken**  
120 mm  
gebogen  
curved

**HSC 240-15**  
**Semken**  
150 mm  
gerade  
straight  
Feine Hakenpinzette  
Delicate Forceps

**HSC 241-15**  
**Semken**  
150 mm  
gebogen  
curved

**L-HSC 244-18**  
**Taylor**  
180 mm  
Feine Hakenpinzette  
Delicate Forceps



**HSC 180-08**  
80 mm

**HSC 182-09**  
90 mm

**HSC 184-10**  
105 mm

**HSC 186-11**  
115 mm

**HSC 188-13**  
130 mm

**HSC 190-14**  
145 mm  
gerade  
straight

Feine Präparierpinzetten  
Fine preparation forceps



**HSC 185-10**  
105 mm

**HSC 187-11**  
115 mm

**HSC 189-13**  
130 mm

**HSC 191-14**  
145 mm  
gebogen  
curved



**L-HSC 126-18**  
**Taylor**  
180 mm

Präparaten-Faßpinzetten  
Specimen seizing forceps



**HSC 138-20**  
**Waugh**  
200 mm



**HSC 192-08**  
80 mm  
Splitterpinzette  
Splinter forceps



**HSM 145-01**  
90 mm  
Kombinierte Haar-  
und Splitterpinzette  
Combined hair and  
splinter forceps



**HSC 196-10**  
105 mm

Splitterpinzetten  
Splinter forceps



**HSC 197-10**  
105 mm



**HSC 510-16**  
160 mm  
Deckglaspinzette,  
gerade  
Cover glass forceps,  
straight

**HSC 511-16**  
160 mm  
Deckglaspinzette,  
gebogen  
Cover glass forceps,  
curved



**HSC 512-10**  
105 mm  
Deckglaspinzette,  
gebogen  
Cover glass forceps,  
curved



**HSC 513-10**  
105 mm  
Deckglaspinzette,  
gebogen  
Cover glass forceps,  
curved



**HSC 514-10**  
105 mm  
Deckglaspinzette,  
teflonbeschichtet  
Cover glass forceps,  
Teflon coated



**HSC 533-12**  
115 mm



**HSC 534-12**  
115 mm  
Kreuzpinzette, gerade  
Self-locking forceps, straight



**HSC 535-11**  
115 mm



**HSC 816-10**  
105 mm

**HSC 816-13**  
130 mm

**HSC 816-16**  
160 mm  
Deckglaspinzette,  
einfache Ausführung  
Cover-glass forceps,  
simple type



**HSC 817-10**  
105 mm

**HSC 817-13**  
130 mm

**HSC 817-16**  
160 mm  
Deckglaspinzette, gebogen,  
einfache Ausführung  
Cover-glass forceps, curved,  
simple type



**L-HSC 501-00**  
**Miller**  
150 mm  
Faßpinzette,  
gekreuzt  
Cross action  
seizing forceps



**L-HSC 214-13**  
130 mm

**L-HSC 216-14**  
145 mm  
gerade  
straight



**L-HSC 215-13**  
130 mm

**L-HSC 217-14**  
145 mm  
gebogen  
curved

Feine Hakenpinzette  
Delicate Forceps



**L-HSC 243-15**  
**Gillies**  
150 mm  
gerade  
straight



**HSC 550-10**  
105 mm



**HSC 551-10**  
105 mm



**HSC 559-10**  
105 mm



**HSC 570-11**  
100 mm

**HSC 552-11**  
115 mm

**HSC 553-11**  
115 mm

**HSC 561-11**  
115 mm

**HSC 554-13**  
130 mm

**HSC 555-13**  
130 mm

**HSC 563-13**  
130 mm

**HSC 556-14**  
145 mm  
gerade  
straight

**HSC 557-14**  
145 mm  
gebogen  
curved

**HSC 565-14**  
145 mm  
stark gebogen  
strongly curved

Mikroskopische Pinzetten  
Microscopic forceps

**HSC 571-12**  
115 mm

**HSC 572-13**  
130 mm

**HSC 573-14**  
145 mm

**HSC 574-16**  
160 mm

**HSC 575-20**  
200 mm  
Pinzette, teflonbeschichtet,  
gebogen, gerieft  
Forceps, Teflon coated,  
curved, serrated



**HSC 530-30**  
Brenngutträgerpinzette  
Fuel carrier pincers



**HSC 524-16**  
**Geppert**  
165 mm  
Pinzette zum Greifen von  
Kleinstteilen (z. B. kleine  
Schrauben) bzw. schlecht zu  
greifende Teile im Labor  
Forceps for gripping smallest  
parts (f. e. small screws) or  
parts bad to be gripped in  
the laboratory



**HSC 525-30**  
**Geppert**  
300 mm  
Pinzette zum Abdampfen im Labor;  
hitzebeständig bis 130°C  
Forceps for evaporating in the  
laboratory, heat resistant to 130° C

# Pinzetten Forceps

5

## Diverse Pinzetten Various forceps

H

aus rostfreiem Stahl  
from stainless steel

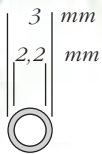

**HSC 700-93**  
90 mm  
Nr. 2

Faßpinzetten für Gewebe und Tumore  
Forceps for taking hold of tumour and tissue

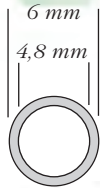

**HSC 701-96**  
90 mm  
Nr. 1

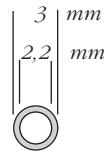

**HSC 702-93**  
90 mm

Faßpinzetten für Gewebe und Tumore, mit Stellschraube  
Forceps for taking hold of tumour and tissue, with adjusting screw

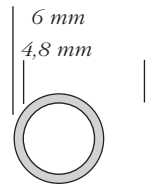

**HSC 703-96**  
90 mm



**L-HSC 020-05**  
London-College

einfache Ausführung, gerieft  
simple pattern, serrated



**L-HSC 021-09**  
Meriam



**HSC 818-11**  
110 mm

Uhrmacherpinzette, einfache Ausführung  
Forceps for watch-makers, simple type



**HSC 819-10**  
105 mm

Uhrmacherpinzette, gebogen, einfache Ausführung  
Forceps for watch-makers, curved simple type



**HSC 045-14**  
140 mm  
Ohrpinzette, Lucae  
Ear forceps, Lucae



**HSC 800-10**  
105 mm

**HSC 801-11**  
115 mm

**HSC 802-13**  
130 mm

**HSC 803-14**  
145 mm

**HSC 804-16**  
160 mm

**HSC 805-20**  
200 mm  
Pinzetten, spitz, einfache Ausführung  
Forceps, sharp, simple type



**HSC 821-10**  
105 mm

**HSC 822-11**  
115 mm

**HSC 823-13**  
130 mm

**HSC 824-14**  
145 mm

**HSC 825-16**  
160 mm

**HSC 826-20**  
200 mm  
Pinzetten, spitz, gebogen, einfache Ausführung  
Forceps, sharp, curved, simple type



**HSC 807-10**  
105 mm

**HSC 808-11**  
115 mm

**HSC 809-13**  
130 mm

**HSC 810-14**  
145 mm

**HSC 811-16**  
160 mm

**HSC 812-20**  
200 mm

**HSC 813-25**  
250 mm

**HSC 814-30**  
300 mm  
Pinzetten, einfache Ausführung  
Forceps, simple type



**HSC 831-10**  
105 mm

**HSC 832-11**  
115 mm

**HSC 833-13**  
130 mm

**HSC 834-14**  
145 mm

**HSC 835-16**  
160 mm

**HSC 836-20**  
200 mm

**HSC 837-25**  
250 mm

**HSC 838-30**  
300 mm  
Pinzetten, gebogen, einfache Ausführung  
Forceps, curved, simple type

Titan ist hart wie Stahl,  
jedoch 40% leichter.  
Der Schmelzpunkt liegt bei 1800°C,  
darum können die Pinzetten  
nicht verkleben.



Titanium is as hard as steel,  
whilst being 40% lighter.  
The melting point is 1800°C,  
so that the tweezers  
cannot adhere.



**L-HTC 033-05**  
London College  
"Titan"  
150 mm  
gerieft

**HTC 034-05**  
College  
"Titan"  
160 mm  
gerieft  
serrated

**HTC 035-09**  
Meriam  
"Titan"  
160 mm  
gerieft  
serrated

**L-HTC 036-15**  
"Titan"  
150 mm  
gerieft  
serrated

**L-HTC 037-15**  
"Titan"  
150 mm  
gerieft  
serrated

**HTC 038-14**  
"Titan"  
145 mm

**HTC 050-12**  
"Titan"  
120 mm  
glatte Spitzen  
smooth tips

**HTC 052-13**  
"Titan"  
130 mm  
glatte Spitzen  
smooth tips

**HTC 054-16**  
"Titan"  
165 mm  
geriefte Spitzen  
grooved tips

**HTC 057-16**  
"Titan"  
165 mm

**TITAN-Pinzetten:** besonders leicht, besonders hygienisch  
**TITANIUM-forceps:** particularly light, particularly hygienic

**"TITAN" Lötpinzette,**  
besonders lotabweisend.  
**"TITANIUM" soldering tweezers,**  
particularly solder-repellent.

**Titan Instrumente** sind 40% leichter als Instrumente aus rostfreiem Stahl.

Sie sind absolut rostsicher und geeignet für alle gängigen Reinigungs- und Sterilisationsarten.

**Titanium instruments** are 40% lighter than instruments made of stainless steel.

They are absolutely rust-proof and suitable for all common types of cleaning and sterilization.

Titan ist hart wie Stahl,  
jedoch 40% leichter.  
Der Schmelzpunkt liegt bei 1800°C,  
darum können die Pinzetten  
nicht verkleben.



Titanium is as hard as steel,  
whilst being 40% lighter.  
The melting point is 1800°C,  
so that the tweezers  
cannot adhere.



**HTC 090-11**  
*"Titan"*  
110 mm  
TITAN-Präparierpinzette,  
einfache Ausführung  
TITANIUM dissecting tweezers,  
simple type



**HTC 091-10**  
*"Titan"*  
105 mm  
gebogen, einfache Ausführung  
curved, simple type



**HTC 080-20**  
200 mm  
TITAN-Pinzette, anatomisch, einfache Ausführung  
Dressing TITANIUM-forceps, simple type

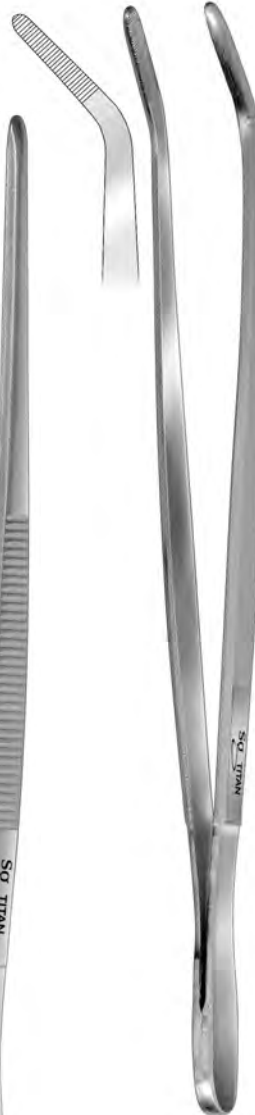

**HTC 081-20**  
200 mm  
gebogen  
curved



**HTC 084-20**  
200 mm  
TITAN-Pinzette, spitz, einfache Ausführung  
TITANIUM-forceps, sharp, simple type



**HTC 085-20**  
200 mm  
gebogen  
curved



*Wironit*  
aus Wironit Stahl  
from Wironit steel



aus rostfreiem Stahl  
from stainless steel



**L-HWJ 008-17** **L-HWJ 011-16**  
Mikro-Präpariersonden,  
aus Wironit Stahl, einendig  
mit Achtkantgriff  
Micro dissecting probes,  
from Wironit steel, single ended  
with octogonal handle

**L-HWJ 015-09**



**L-HSJ 001-06** **L-HSJ 002-17** **L-HSJ 003-23** **L-HSJ 004-42** **L-HSJ 005-43** **L-HSJ 006-44**  
*fig. 6* *fig. 17* *fig. 23* *fig. 42* *fig. 43* *fig. 44*  
Sonden, einendig mit Rundgriffen  
Probes single ended with round handles

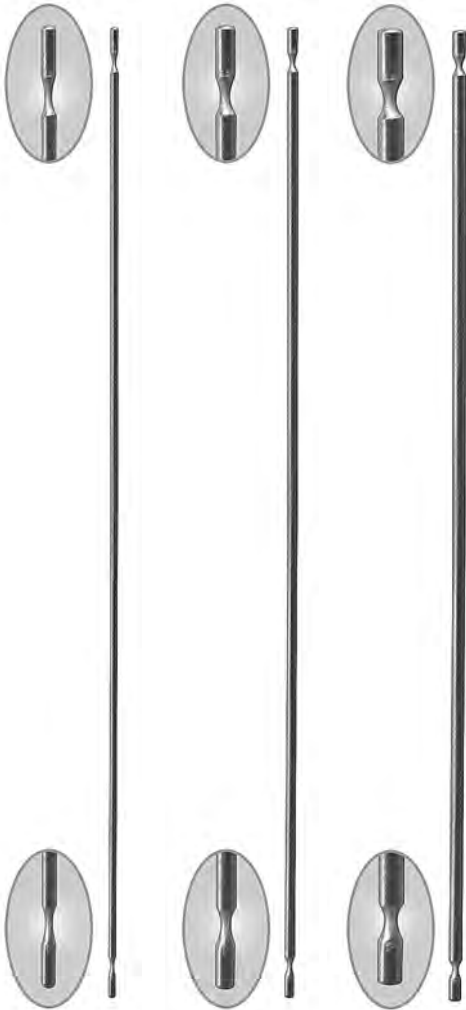

**HWP 026-10**  
130 mm  
Ø 1,0 mm

**HWP 027-15**  
130 mm  
Ø 1,5 mm

**HWP 028-20**  
130 mm  
Ø 2,0 mm

**HWP 029-10**  
145 mm  
Ø 1,0 mm

**HWP 030-15**  
145 mm  
Ø 1,5 mm  
Knopfsonden  
Probes



**HSJ 043-05**  
*Fig. 3-05*  
Präpariersonde, gebogen  
Dissection probe, curved



**HSJ 047-17**  
*Fig. 7-17*  
Präpariersonde, gebogen  
Dissection probe, curved



**HSJ 048-02**  
*Fig. 8-02*  
Präpariersonde, gebogen  
Dissection probe, curved



**HSJ 049-11**  
*Fig. 9-11*  
Präpariersonde, gebogen  
Dissection probe, curved



Wironit Instrumente sind aus einer Speziallegierung gefertigt und weisen folgende Vorteile auf:

- ✓ nichtrostend
- ✓ antimagnetisch
- ✓ säurebeständig

Sie sind formschön, liegen leicht in der Hand und sind von langer Lebensdauer.



Wironit instruments are made of a special alloy and show the following advantages:

- ✓ rust resistant
- ✓ anti-magnetic
- ✓ acid resistant

They are beautifully designed and of unlimited durability.



Solingen



**HWO 002-00**  
140 mm  
gerade  
straight



**HWO 001-00**  
140 mm  
abgewinkelt  
angled



**HWO 003-00**  
140 mm  
gebogen  
curved



**HWO 004-00**  
140 mm  
gerade  
straight



**HWO 005-01**  
140 mm  
abgewinkelt  
angled



**HWO 007-02**  
140 mm  
abgewinkelt  
angled



**HWO 008-14**  
140 mm  
Präpariernadel  
mit Plastikheft, gerade  
Dissecting needle  
with plastic handle, straight



**HWO 010-16**  
160 mm  
Präpariernadel aus  
Stahl, gerade  
Dissecting needle,  
steel handle, straight

Präpariernadel aus Stahl  
Dissecting needle, steel

Präpariernadel aus Stahl, lanzettenförmig  
Dissecting needle, steel, with lancet tip

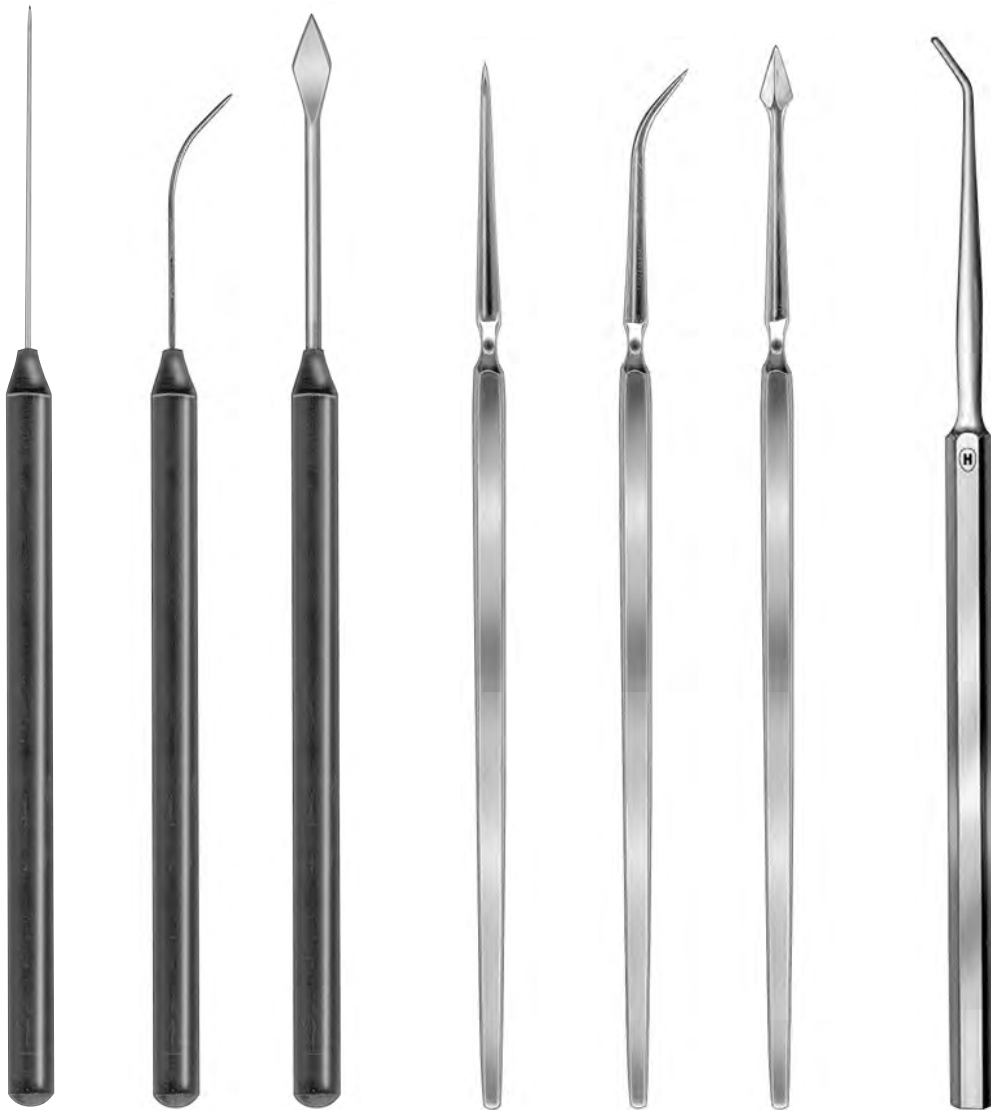

**HSD 102-01**    **HSD 103-02**    **HSD 104-03**  
 Präpariernadel mit Plastikheft  
 Dissecting needle with plastic handle

**HSD 106-01**    **HSD 107-02**    **HSD 108-03**  
 Präpariernadel mit Metallheft  
 Dissecting needle with metal handle

**HSD 101-17**  
 175 mm  
 Finder mit Metallheft,  
 stumpf  
 Seeker with metal  
 handle, blunt

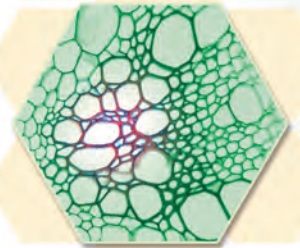

Solingen



**HWO 020-17** 170 mm  
Ø 5 mm  
Nadelhalter für Abstrichösen und Präpariernadeln,  
mit **Wironit** Oberteil und Aluminiumgriff.  
Für Abstrichösen und Präpariernadeln bis max. Ø 1,0 mm.

**HWO 022-24** 240 mm  
Ø 8,5 mm

**HWO 024-24** 240 mm  
Ø 6,5 mm

Needle holder for specimen loops and dissecting needles,  
with **Wironit** upper part and aluminium handle.  
For specimen loops and dissecting needles up to max. Ø 1,0 mm.

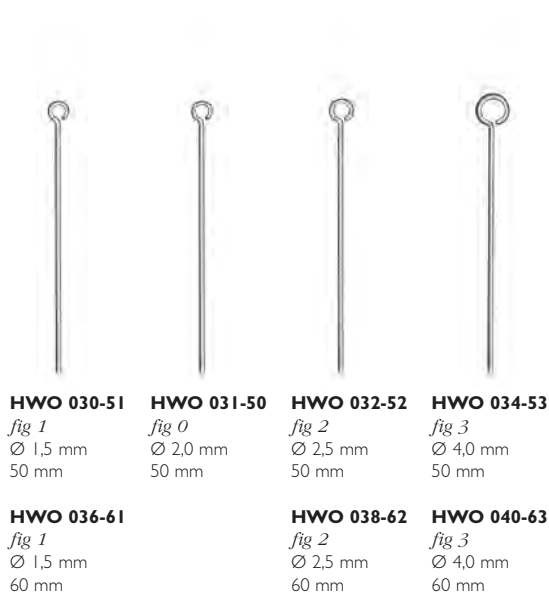

**HWO 030-51** *fig 1*  
Ø 1,5 mm  
50 mm

**HWO 031-50** *fig 0*  
Ø 2,0 mm  
50 mm

**HWO 032-52** *fig 2*  
Ø 2,5 mm  
50 mm

**HWO 034-53** *fig 3*  
Ø 4,0 mm  
50 mm

**HWO 036-61** *fig 1*  
Ø 1,5 mm  
60 mm

**HWO 038-62** *fig 2*  
Ø 2,5 mm  
60 mm

**HWO 040-63** *fig 3*  
Ø 4,0 mm  
60 mm

Ösen  
Loops

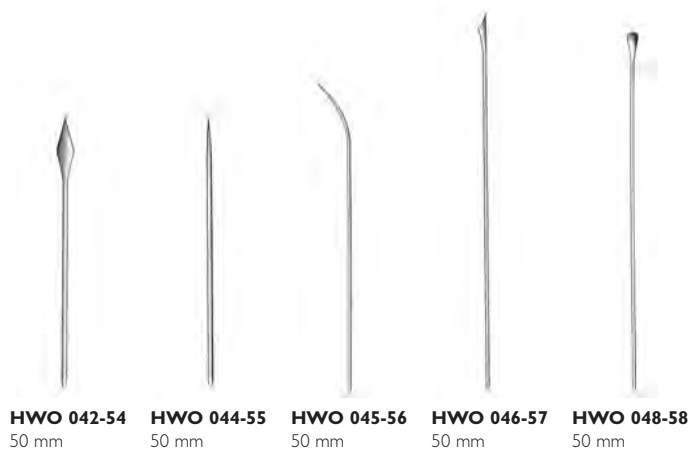

**HWO 042-54** 50 mm

**HWO 044-55** 50 mm

**HWO 045-56** 50 mm

**HWO 046-57** 50 mm

**HWO 048-58** 50 mm

Nadeln  
Needles



**HWO 070-21** 210 mm  
aus Metall  
from steel

**HWO 072-20** 200 mm  
mit Plastikheft  
with plastic handle

Abstrichöse  
Specimen loop



**ERGO BRUSH**

Dieser einzigartige Griff für Pinsel unterschiedlicher Größen ermöglicht dank der geneigten Ausführung im Gegensatz zu den herkömmlichen Pinseln, bei denen der Griff den Zahn verdeckt und der Nutzer gezwungen ist, ständig seine Position zu verändern, die ständige freie Sicht auf das Werkstück und die Aufrechterhaltung der korrekten Körperhaltung. Durch das einfache Drehen der Spitze werden alle Punkte erreicht, an denen gearbeitet werden soll, um zu modellieren bzw. Material oder Farbe aufzutragen.

**ERGO BRUSH**

Due to the inclined design this unique handle for brushes of various sizes allows – contrary to conventional brushes where the handle covers the tooth and the user is forced to constantly change his position – the constant clear view of the work piece and the maintenance of proper body position. By simply rotating the tip all points to be worked on will be reached to model or to apply material or colour.



- Nur in Kombination zu nutzen!
- Use only in combination!

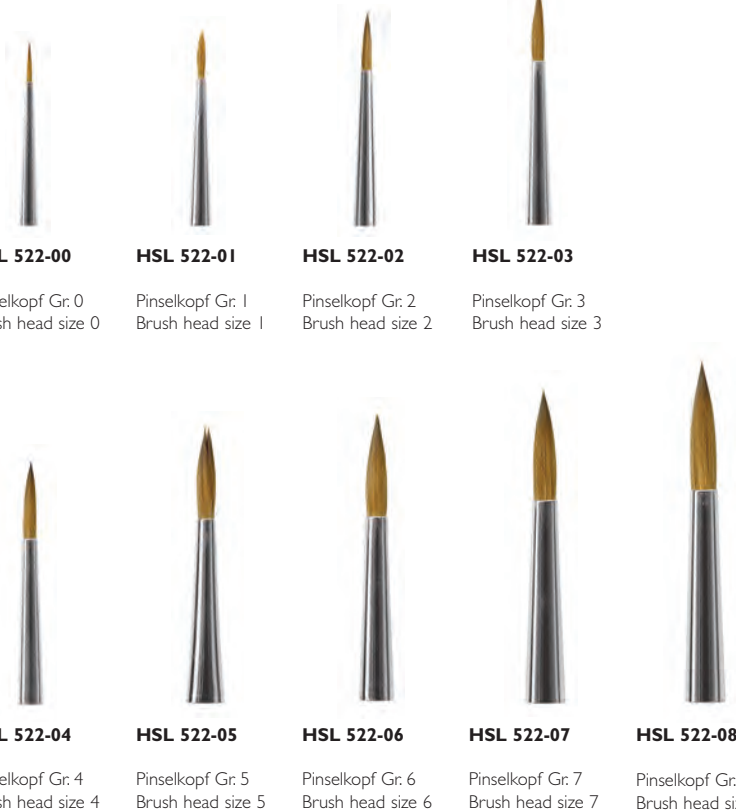

**HSL 522-00**

Pinselkopf Gr: 0  
Brush head size 0

**HSL 522-01**

Pinselkopf Gr: 1  
Brush head size 1

**HSL 522-02**

Pinselkopf Gr: 2  
Brush head size 2

**HSL 522-03**

Pinselkopf Gr: 3  
Brush head size 3

**HSL 522-04**

Pinselkopf Gr: 4  
Brush head size 4

**HSL 522-05**

Pinselkopf Gr: 5  
Brush head size 5

**HSL 522-06**

Pinselkopf Gr: 6  
Brush head size 6

**HSL 522-07**

Pinselkopf Gr: 7  
Brush head size 7

**HSL 522-08**

Pinselkopf Gr: 8  
Brush head size 8

**HSL 521-71**

**ERGO-BRUSH Pinselhalter**  
für Pinselköpfe Gr: 5 - 8

**ERGO-BRUSH Brush holder**  
for brush heads size 5 - 8

**HSL 520-06**

**ERGO-BRUSH Pinselhalter**  
für Pinselköpfe Gr: 0 - 4

**ERGO-BRUSH Brush holder**  
for brush heads size 0 - 4



**HSL 563-00**

Halterung für Pinsel  
Brush Station

**Auch geeignet für alle Impfösenhalter**  
**Also suitable for all specimen loop holders**

Chirurgische Nadeln / in Packungen zu 12 Stück  
Suture needles / in packages of 12 pcs.

Federöhr  
Spring eye

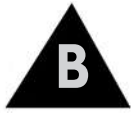

HSD 430-10  
fig. 10



HSD 446-10  
fig. 10



HSD 462-10  
fig. 10



HSD 478-10  
fig. 10



HSD 431-11  
fig. 11



HSD 447-11  
fig. 11



HSD 463-11  
fig. 11



HSD 479-11  
fig. 11



HSD 432-12  
fig. 12



HSD 448-12  
fig. 12



HSD 464-12  
fig. 12



HSD 480-12  
fig. 12



HSD 433-13  
fig. 13



HSD 449-13  
fig. 13



HSD 465-13  
fig. 13



HSD 481-13  
fig. 13



HSD 434-14  
fig. 14



HSD 450-14  
fig. 14



HSD 466-14  
fig. 14



HSD 482-14  
fig. 14



HSD 435-15  
fig. 15



HSD 451-15  
fig. 15



HSD 467-15  
fig. 15



HSD 483-15  
fig. 15



HSD 436-16  
fig. 16



HSD 452-16  
fig. 16



HSD 468-16  
fig. 16



HSD 484-16  
fig. 16

Chirurgische Nadeln, Form **G**, 1/2 Kreis  
Suture needles form **G**, 1/2 circle

Chirurgische Nadeln, Form **B**, 3/8 Kreis  
Suture needles form **B**, 3/8 circle

Chirurgische Nadeln, Form **G**, 1/2 Kreis  
Suture needles form **G**, 1/2 circle

Chirurgische Nadeln, Form **B**, 3/8 Kreis  
Suture needles form **B**, 3/8 circle



**L-HSE 010-09**  
**Micro-Hartmann**  
90 mm  
Mikroklemme, sehr fein, gerade  
Micro forceps, very delicate, straight



**L-HSE 017-12**  
**Micro-Halsted**  
125 mm  
Mikroklemme, sehr fein, gebogen  
Micro forceps, very delicate, curved



**L-HSE 011-09**  
**Micro-Hartmann**  
90 mm  
Mikroklemme, sehr fein, gebogen  
Micro forceps, very delicate, curved

**L-HSE 016-12**  
**Micro-Halsted**  
125 mm  
Mikroklemme, sehr fein, gerade  
Micro forceps, very delicate, straight



**HSE 004-35**  
35 mm  
Gefäßklemme, gerade  
Serrefine, straight



**HSE 003-35**  
35 mm  
Gefäßklemme, gebogen  
Serrefine, curved



**HSE 006-50**  
50 mm  
Gefäßklemme, gerade  
Serrefine, straight



**HSE 005-50**  
50 mm  
Gefäßklemme, gebogen  
Serrefine, curved

Die Mikroklemmen - wir wissen, wie wichtig die mikrochirurgische Genauigkeit sein kann. Daher bieten Ihnen unsere Klemmen die größtmögliche Genauigkeit auch bei den feinsten Verfahren.

Micro forceps - we know how important microsurgical accuracy can be, so our forceps are well prepared to give you precise performance; it does not matter how fine the procedure is.



**HSE 012-09  
Baby-Mosquito**  
90 mm  
Schlauchklemmen, gerade  
Tubing clamps, straight



**HSE 013-09  
Baby-Mosquito**  
90 mm  
Schlauchklemmen, gebogen  
Tubing clamps, curved



**HSE 020-09  
Halstead-Mosquito**  
90 mm

**L-HSE 022-12  
Halstead-Mosquito**  
120 mm

**L-HSE 024-14  
Halstead-Mosquito**  
140 mm  
Schlauchklemmen, gerade  
Tubing clamps, straight



**HSE 021-09  
Halstead-Mosquito**  
90 mm

**L-HSE 023-12  
Halstead-Mosquito**  
120 mm

**L-HSE 025-14  
Halstead-Mosquito**  
140 mm  
gebogen  
curved



**L-HSE 062-13  
Pean**  
130 mm  
gerade  
straight

**L-HSE 064-14  
Pean**  
140 mm  
gerade  
straight  
Schlauchklemmen  
Tubing clamps

**L-HSE 066-16  
Pean**  
160 mm  
gerade  
straight

**L-HSE 070-18  
Pean**  
180 mm  
gerade  
straight

**L-HSE 072-20  
Pean**  
200 mm  
gerade  
straight



**L-HSE 063-13  
Pean**  
130 mm  
gebogen  
curved

**L-HSE 065-14  
Pean**  
140 mm  
gebogen  
curved  
Schlauchklemmen  
Tubing clamps

**L-HSE 067-16  
Pean**  
160 mm  
gebogen  
curved

**L-HSE 069-18  
Pean**  
180 mm  
gebogen  
curved

**L-HSE 071-20  
Pean**  
200 mm  
gebogen  
curved



**HSE 086-14**  
**Kocher (Ochsner)**  
140 mm

**HSE 088-16**  
**Kocher (Ochsner)**  
160 mm

**HSE 092-18**  
**Kocher (Ochsner)**  
180 mm

**HSE 094-20**  
**Kocher (Ochsner)**  
200 mm  
Schlauchklemmen, gerade  
Tubing clamps, straight



*kunststoffbeschichtet*  
*plastic-coated*

**HSE 900-16**  
160 mm

**HSE 902-18**  
180 mm

**HSE 904-20**  
200 mm  
Schlauchklemmen  
Tubing clamp



**HSE 087-14**  
**Kocher (Ochsner)**  
140 mm

**HSE 089-16**  
**Kocher (Ochsner)**  
160 mm

**HSE 093-18**  
**Kocher (Ochsner)**  
180 mm

**HSE 095-20**  
**Kocher (Ochsner)**  
200 mm  
Schlauchklemmen, gebogen  
Tubing clamps, curved





**HSE 772-20**  
**Gross-Maier**  
200 mm

**HSE 774-25**  
**Gross-Maier**  
250 mm  
Faß- und Kornzangen, gerade  
Grasping and dressing forceps, straight

**HSE 773-20**  
**Gross-Maier**  
200 mm

**HSE 775-25**  
**Gross-Maier**  
250 mm  
Faß- und Kornzangen, gebogen  
Grasping and dressing forceps, curved

**HSE 786-25**  
**Foerster**  
250 mm  
Sterilisierzangen, gerade  
Sterilizing forceps, straight



**HSO 095-10**  
100 mm  
Muskelhaken, scharf,  
doppelt, 4-zahlig  
Dissecting tenaculum,  
sharp, double, 4-prongs



**HSE 308-09**  
90 mm  
Fassklemme, gebogen, sterilisierbar  
Hervorragend geeignet zum Lösen eines Objektträgers.  
Grasping clamp, curved, sterilisable  
Ideally suitable for removing an object holder.



**HSV 006-17**  
Ainsworth  
170 mm  
Ohrlochzange  
Ear puncher



**HWL 100-13**  
**Fahnenstock**  
130 mm

**HWL 101-17**  
**Fahnenstock**  
175 mm

**HWL 102-14**  
140 mm

**HWL 103-14**  
140 mm

**HWL 106-17**  
**Gritzman**  
170 mm

Labormesser; aus Wironit Stahl  
Laboratory knives, from Wironit steel

**HSL 115-17**  
**Fahnenstock**  
175 mm  
Wachsmesser aus rostfreiem  
Stahl, schwarzes Holzheft  
Wax knives from stainless steel,  
black wooden handle



**HSL 121-18**  
180 mm

Labormesser; aus rostfreiem Stahl,  
Laboratory knives, from stainless steel



**HSL 122-16**  
**Gritzman**  
165 mm



**HSL 130-17**  
170 mm  
Korkmesser;  
aus rostfreiem Stahl,  
Kunststoffgriff,  
Klinge: 75 mm  
Cork knife,  
from stainless steel,  
plastic handle,  
Blade: 75 mm



**HSL 132-20**  
200 mm  
Labormesser;  
aus rostfreiem Stahl,  
Kunststoffgriff,  
Klinge: 90 mm  
Laboratory knife,  
from stainless steel,  
plastic handle,  
blade: 90 mm

Nur für technische Zwecke  
For technical purposes only



Wironit Instrumente sind aus einer Speziallegierung gefertigt und weisen folgende Vorteile auf:

- ✓ nichtrostend
- ✓ antimagnetisch
- ✓ säurebeständig

Sie sind formschön, liegen leicht in der Hand und sind von langer Lebensdauer.



Wironit instruments are made of a special alloy and show the following advantages:

- ✓ rust resistant
- ✓ anti-magnetic
- ✓ acid resistant

They are beautifully designed and of unlimited durability.

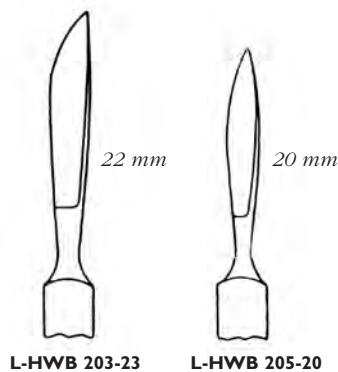
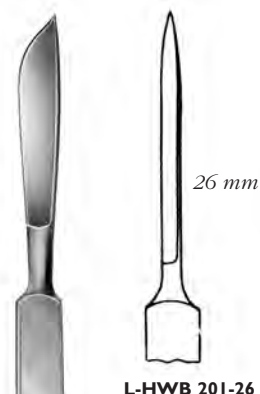

**L-HWB 201-26 - L-HWB 205-20**  
Präpariermesser; sehr fein  
Preparation knives, very delicate  
Cuchillos para preparación, muy finos  
Couteaux à préparation, très délicates

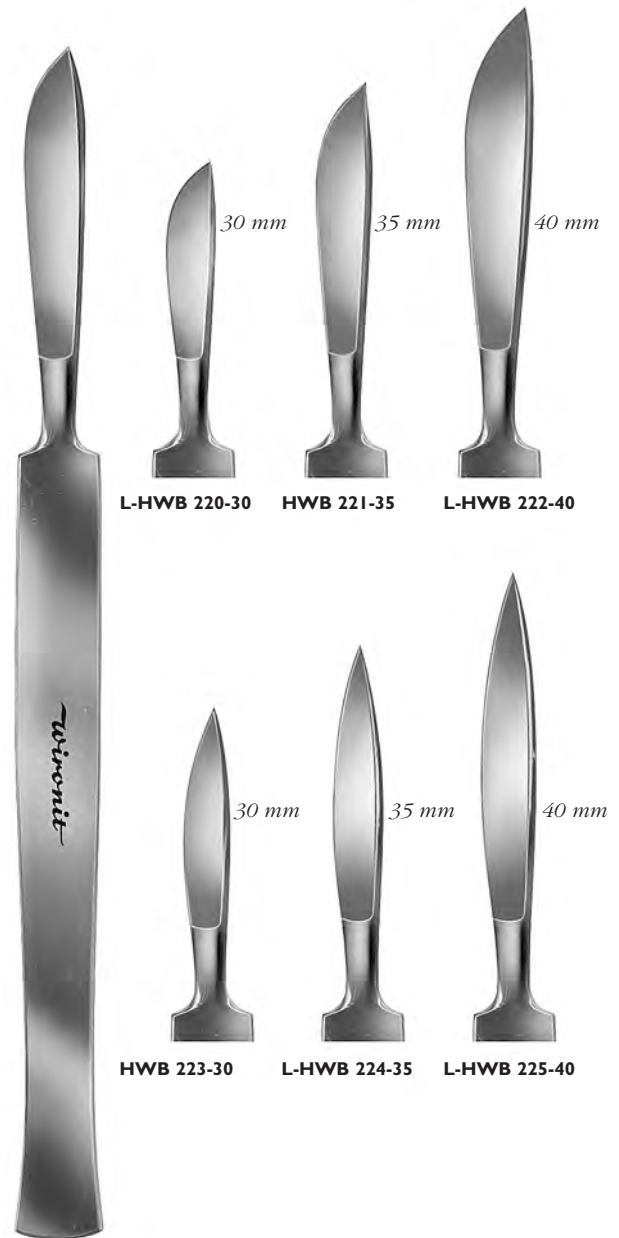

**L-HWB 220-30 - L-HWB 225-40**  
Feine Skalpelle  
Delicate scalpels  
Bisturries finas  
Bistouris fins

Nur für technische Zwecke  
For technical purposes only



**HSB 839-00**  
Rasierklingen, Packung 10 Klingen  
Razor blades, pack of 10 blades



**HWB 300-00**  
**Kling-EX**  
Skalpellsklingen-Abnehmer  
Scalpel-blade remover

Für Griff L-**HSB 805-03**, L-**HSB 808-16**, L-**HSB 809-16**  
For handle L-**HSB 805-03**, L-**HSB 808-16**, L-**HSB 809-16**



**HSB 704-10**  
*fig. 10*  
unsteril  
not sterile  
Skalpellsklingen, in Packungen zu 100 Stück,  
Scalpel blades, in packages of 100 pieces



**HSB 705-11**  
*fig. 11*  
unsteril  
not sterile  
Skalpellsklingen, in Packungen zu 100 Stück,  
Scalpel blades, in packages of 100 pieces

**HSB 815-10**  
*fig. 10*  
steril  
sterile  
Skalpellsklingen, in Packungen zu 100 Stück,  
Scalpel blades, in packages of 100 pieces

**HSB 816-11**  
*fig. 11*  
steril  
sterile  
Skalpellsklingen, in Packungen zu 100 Stück,  
Scalpel blades, in packages of 100 pieces



**L-**HSB 805-03****  
No. 3  
125 mm  
Skalpellsgriff, für Klingen HSB 704-10 bis HSB 819-15  
Scalpel handle, for blades HSB 704-10 to HSB 819-15



**L-**HSB 808-16****  
160 mm



**L-**HSB 809-16****  
160 mm



**HSB 706-12**  
*fig. 12*  
unsteril  
not sterile  
Skalpellsklingen, in Packungen zu 100 Stück,  
Scalpel blades, in packages of 100 pieces



**HSB 707-15**  
*fig. 15*  
unsteril  
not sterile  
Skalpellsklingen, in Packungen zu 100 Stück,  
Scalpel blades, in packages of 100 pieces



**HSB 819-15**  
*fig. 15c*  
steril  
sterile

**HSB 817-12**  
*fig. 12*  
steril  
sterile  
Skalpellsklingen, in Packungen zu 100 Stück,  
Scalpel blades, in packages of 100 pieces

**HSB 818-15**  
*fig. 15*  
steril  
sterile  
Skalpellsklingen, in Packungen zu 100 Stück,  
Scalpel blades, in packages of 100 pieces

Nur für technische Zwecke  
For technical purposes only

Für Griff L-HSB 820-04  
For handle L-HSB 820-04



**HSB 709-20**  
*fig. 20*  
unsteril  
not sterile  
Skalpellsklingen, in Packungen zu 100 Stück,  
Scalpel blades, in packages of 100 pieces

**HSB 710-21**  
*fig. 21*  
unsteril  
not sterile  
Skalpellsklingen, in Packungen zu 100 Stück,  
Scalpel blades, in packages of 100 pieces

**HSB 711-22**  
*fig. 22*  
unsteril  
not sterile  
Skalpellsklingen, in Packungen zu 100 Stück,  
Scalpel blades, in packages of 100 pieces

**HSB 828-20**  
*fig. 20*  
steril  
sterile  
Skalpellsklingen, in Packungen zu 100 Stück,  
Scalpel blades, in packages of 100 pieces

**HSB 829-21**  
*fig. 21*  
steril  
sterile  
Skalpellsklingen, in Packungen zu 100 Stück,  
Scalpel blades, in packages of 100 pieces

**HSB 830-22**  
*fig. 22*  
steril  
sterile  
Skalpellsklingen, in Packungen zu 100 Stück,  
Scalpel blades, in packages of 100 pieces



**HSB 712-23**  
*fig. 23*  
unsteril  
not sterile  
Skalpellsklingen, in Packungen zu 100 Stück,  
Scalpel blades, in packages of 100 pieces

**HSB 713-24**  
*fig. 24*  
unsteril  
not sterile  
Skalpellsklingen, in Packungen zu 100 Stück,  
Scalpel blades, in packages of 100 pieces

**HSB 714-25**  
*fig. 25*  
unsteril  
not sterile  
Skalpellsklingen, in Packungen zu 100 Stück,  
Scalpel blades, in packages of 100 pieces

**HSB 831-23**  
*fig. 23*  
steril  
sterile  
Skalpellsklingen, in Packungen zu 100 Stück,  
Scalpel blades, in packages of 100 pieces

**HSB 832-24**  
*fig. 24*  
steril  
sterile  
Skalpellsklingen, in Packungen zu 100 Stück,  
Scalpel blades, in packages of 100 pieces

**HSB 833-25**  
*fig. 25*  
steril  
sterile  
Skalpellsklingen, in Packungen zu 100 Stück,  
Scalpel blades, in packages of 100 pieces



**L-HSB 820-04**  
No. 4  
135 mm  
Skalpellsgriff, für Klengen HSB 709-20 bis HSB 833-25  
Scalpel handle, for blades HSB 709-20 to HSB 833-25



**HSB 913-20**  
*fig. 00*  
unsteril  
not sterile

**HSB 921-03**  
*fig. 3*  
unsteril  
not sterile



**HSB 925-05**  
*fig. 5*  
unsteril  
not sterile

**HSB 927-06**  
*fig. 6*  
unsteril  
not sterile



**HSB 929-07**  
*fig. 7*  
unsteril  
not sterile  
Skalpellsklingen, in Packungen zu 100 Stück, für Griff HSB 910-14  
Scalpel blades, in packages of 100 pcs, for handle HSB 910-14

**HSB 931-08**  
*fig. 8*  
unsteril  
not sterile  
Skalpellsklingen, in Packungen zu 100 Stück, für Griff HSB 910-14  
Scalpel blades, in packages of 100 pcs, for handle HSB 910-14

**HSB 935-12**  
*fig. 12*  
unsteril  
not sterile  
Skalpellsklingen, in Packungen zu 100 Stück, für Griff HSB 910-14  
Scalpel blades, in packages of 100 pcs, for handle HSB 910-14



**HSB 910-14**  
145 mm  
Skalpellsgriff, massiv, für Klengen HSB 913-20 bis HSB 935-12  
Scalpel handle, solid, for blades HSB 913-20 to HSB 935-12

Nur für technische Zwecke  
For technical purposes only

Skalpelle, spitz  
Scalpels, sharp



**HSB 853-19**  
*fig. 19*  
unsteril  
not sterile  
Skalpellschlingen,  
in Packungen zu 100 Stück,  
für Griffe **HSB 840-14**  
Scalpel blades,  
in packages of 100 pcs,  
for handles **HSB 840-14**

**HSB 840-14**  
140 mm  
Skalpelle-Griffe, massiv,  
für Klinge **HSB 853-19**  
Scalpel handles, solid,  
for blade **HSB 853-19**



**HSB 730-25**  
25 mm  
Skalpelle mit Holzgriff, rostfrei, poliert  
Scalpels, wooden handle, stainless steel, polished



**HSB 731-30**  
30 mm



**HSB 732-35**  
35 mm



**HSB 733-40**  
40 mm



**HSB 734-45**  
45 mm



**HSB 896-10**  
*fig. 10*  
Steril  
sterile  
Einmalsskalpelle mit Kunststoffgriff  
in Packungen zu 10 Stück  
Disposable scalpels with plastic handle  
in packages of 10 pieces



**HSB 897-11**  
*fig. 11*  
Steril  
sterile



**HSB 898-12**  
*fig. 12*  
Steril  
sterile



**HSB 899-15**  
*fig. 15*  
Steril  
sterile

Nur für technische Zwecke  
 For technical purposes only



**L-HSO 135-12**  
 125 mm  
 Skalpell-Griff, rund,  
 für Micro-Skalpellklingen  
**HSO 138-62 bis HSO 141-67**  
 Scalpel handle, round,  
 for micro blades  
**HSO 138-62 to HSO 141-67**



**HSO 138-62**  
 fig. 62  
 steril  
 sterile



**HSO 139-64**  
 fig. 64  
 steril  
 sterile



**HSO 140-65**  
 fig. 65  
 steril  
 sterile  
 Mikro-Skalpellklingen  
 in Packungen zu 10 Stück  
 für Griff **HSO 135-12**  
 Micro blades  
 in packages of 10 pieces  
 for handle **HSO 135-12**



**HSO 141-67**  
 fig. 67  
 steril  
 sterile



**HSB 746-00**  
 130 mm  
 Folienmesser  
 Foil knife



**HSB 747-01**  
 Ersatzklingen  
 Spare blades



**HSB 748-02**  
 Ersatzklingen  
 Spare blades

Verpackungseinheit: 10 Stück  
 Standard package: 10 pieces



**HSB 751-01**



**HSB 752-02**



**HSB 756-06**  
 Ersatzklingen  
 für Folienmesser  
**HSB 750-00**  
 Spare blades  
 for foil knife  
**HSB 750-00**

Verpackungseinheit:  
 10 Stück  
 Standard package:  
 10 pieces

**HSB 750-00**  
 Folienmesser  
 mit Klinge **HSB 751-01**  
 Foil knife  
 with blade **HSB 751-01**



**L-HSO 803-03**

### Sicherheits-Skalpellgriff Safety scalpel handle

Dieser Skalpellgriff reduziert das Verletzungsrisiko beim Einsetzen und Entfernen der Klinge auf ein Minimum. Er ist daher besonders für weniger routinierte Anwender zu empfehlen.

- Die Klinge muss nicht mehr im Bereich der Schneide/Spitze gefasst werden.
- Ein weiterer Vorteil ist die konstruktionsbedingte höhere Stabilität für die Klinge bei seitlicher Belastung gegenüber einem herkömmlichen Skalpellgriff.

This scalpel handle reduces the risk of injury when inserting and removing the blade to a minimum. It is therefore particularly recommended for less experienced users.

- The blade no longer has to be held in the area of cutting edge / tip.
- Another advantage is the design-related higher stability for the blade with lateral pressure compared to a conventional scalpel handle.



1 Die Klinge wird im breiten Teil über den unteren Stift gesetzt.  
 The blade is set in the wide part on the lower pin.



2 Anschließend wird die Klinge bis zum Anschlag nach unten gezogen.  
 Then the blade is pulled down to the stop.



3 Die Klinge wird in der Anschlag-Position um 90 Grad geschwenkt ...  
 The blade is rotated in the stop position to 90 degrees ...

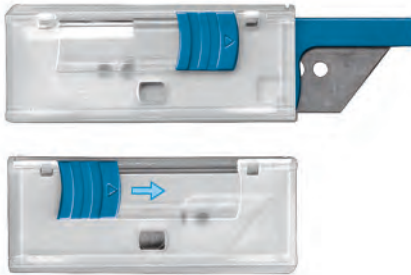

4 ... und zuletzt über den hinteren Stift gehoben.  
 ... and finally lifted over the back pin.

**HSB 782-99**

Trapezklinge Nr. 99 (für HSB 782-00)  
Maße: 60 x 19 mm  
Materialstärke ca. 0,63 mm  
I VE = 10 Stück

Trapezoid blade No. 99 (for HSB 782-00)  
Dimensions: 60 x 19 mm  
Material thickness approx. 0.63 mm  
I pack = 10 pieces

**HSB 783-99**

- Schaber Klinge Nr. 96 (für HSB 783-00)
- Maße: 100 x 14 mm
- Materialstärke ca. 0,4 mm
- I VE = 10 Stück

- Scraper blade No. 99 (for HSB 783-00)
- Dimensions: 100 x 14 mm
- Material thickness approx. 0.4 mm
- I pack = 10 pieces

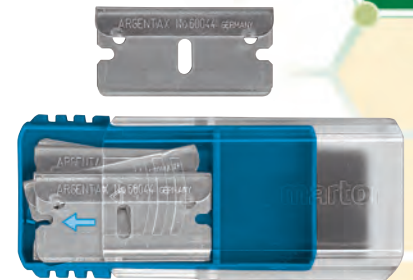
**HSB 784-99**

- Bügelklinge Nr. 60044 mit abgerundeten Spitzen (für HSB 784-00)
- Maße: 39 x 19,4 mm
- Materialstärke ca. 0,3 mm
- I VE = 10 Stück

- Bow blade No. 60044 with rounded tips (for HSB 784-00)
- Dimensions: 39 x 19,4 mm
- Material thickness approx. 0.3 mm
- I pack = 10 pieces

**HSB 782-00  
Securo Maxisafe**

- Sicherheitsmesser mit breitem Einsatzspektrum
- mit dreiseitigem Schieber und Trapezklingen Nr. 99
- vollautomatischer Klinsenrückzug
- robuster Griff aus hochwertigem Kunststoff
- Safety knife with a wide range of uses
- with three-sided slider and trapezoidal blades No. 99
- fully automatic blade retraction
- robust handle made of high-quality plastic

**HSB 783-00****Scrapex**

- Schaber zum mühelosen Entfernen von Papier-, Farb-, Lackresten usw. auf allen glatten Oberflächen
- 100 mm lange Klinge
- rutschfester Griff
- eingebaute Sicherung
- Scraper for effortlessly removing paper, paint, varnish residues etc. from all smooth surfaces
- 100 mm long blade
- non-slip handle
- built-in safeguard

**HSB 784-00****Scrapex Cleanly**

- Schaber zum Reinigen aller glatten Oberflächen
- einfacher Klinsenwechsel
- mit abgerundeter Bügelklinge
- Scraper for cleaning all smooth surfaces
- easy blade change
- with rounded bow blade

**HSB 785-99**

Bügelklinge Nr. 44 (für HSB 785-00)  
 Maße: 39 x 18,7 mm  
 Materialstärke ca. 0,3 mm  
 1 VE = 10 Stück

Bow blade No. 44 (for HSB 785-00)  
 Dimensions: 39 x 18,7 mm  
 Material thickness approx. 0.3 mm  
 1 pack = 10 pieces



**HSB 785-00**
**Scrapex Argentax**

- Klassischer Schaber – befreit alle glatten Oberflächen von Rückständen
- großer abgerundeter Griff mit Bügelklinge
- Classic scraper – removes residue from all smooth surfaces
- large rounded handle with bow blade

**HSB 786-99**

Industrieklinge Nr. 37040 (für HSB 786-01 und HSB 786-02)  
 Maße: 43 x 22 mm  
 Materialstärke ca. 0,4 mm  
 1 VE = 10 Stück

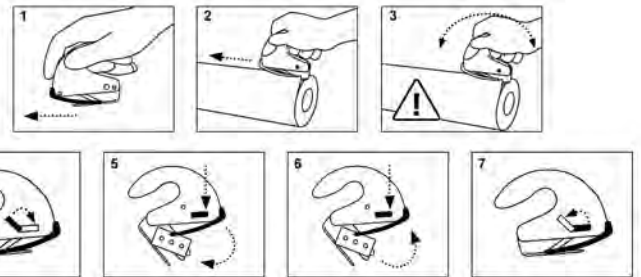
Industrial blade No. 37040 (for HSB 786-01 and HSB 786-02)  
 Dimensions: 43 x 22 mm  
 Material thickness approx. 0.4 mm  
 1 pack = 10 pieces

**HSB 786-01**
**Secumax Opticut D**

- Folien- und Schaumstoffmesser aus teflonisiertem Metall für Schnitte auf Druck mit verdeckt liegender Klinge
- Foil and foam knife made of Teflon-coated metal for cuts under pressure with a concealed blade

**HSB 786-02**
**Secumax Opticut Z**

- Folien- und Schaumstoffmesser aus teflonisiertem Metall für Schnitte auf Zug mit verdeckt liegender Klinge
- Foil and foam knife made of Teflon-coated metal for pulling cuts with a concealed blade

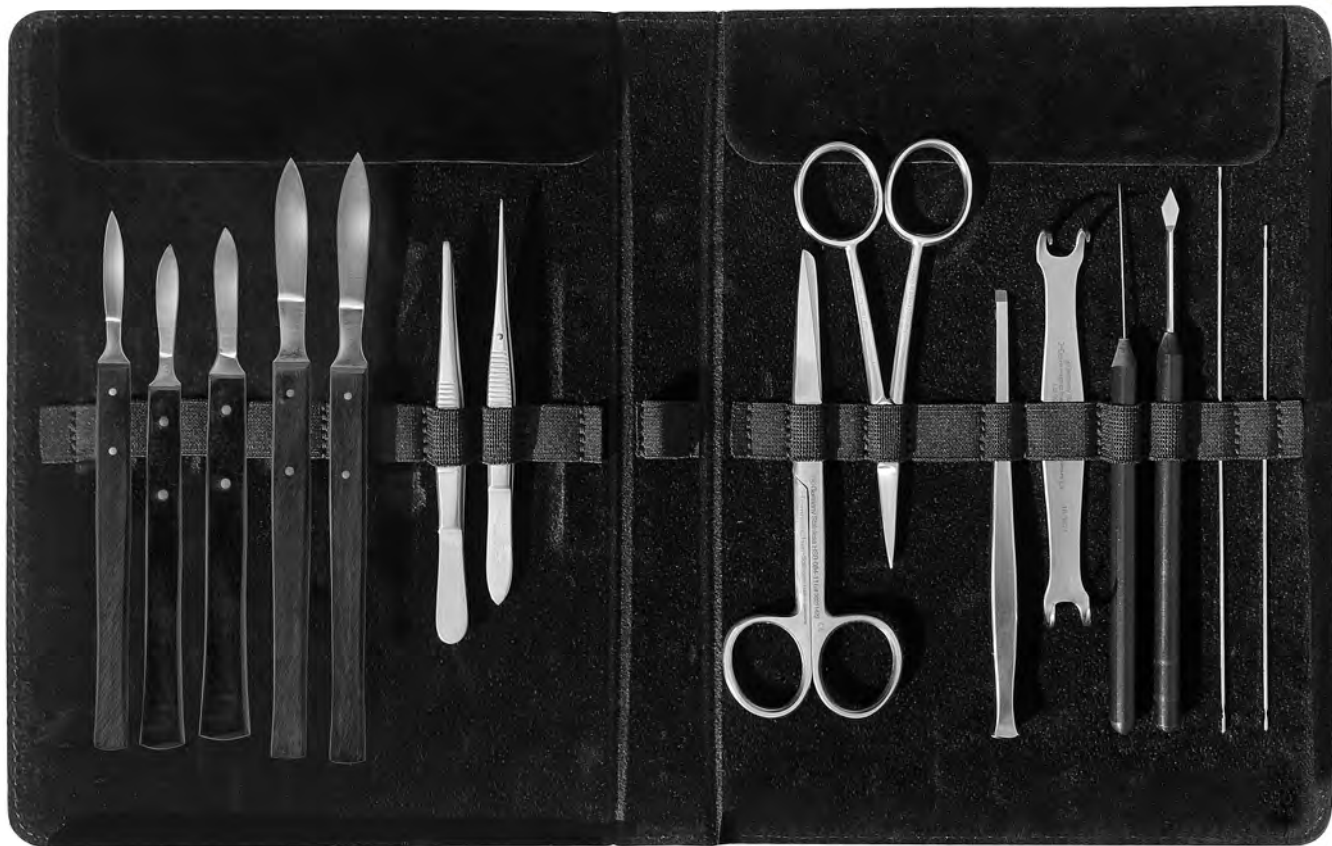

85 = Einzelabbildung - Seite 85  
= Single illustration - page 85

### HSO 122-00

Mikroskopier-Besteck im Holzetui, enthaltend:  
Microscopic dissecting set in wooden case, containing:

**HSB 730-25**  
1 Skalpell, Holzheft  
1 Scalpel, dissecting

85

**HSB 734-45**  
1 Skalpell, Holzheft  
1 Scalpel, dissecting

85

**L-HSB 084-11**  
1 Schere  
1 Dissecting scissors

37

**HSO 095-10**  
1 Muskelhaken  
1 Hook retractor, d. e.

80

**HSB 731-30**  
1 Skalpell, Holzheft  
1 Scalpel, dissecting

85

**HSC 048-10**  
1 Pinzette  
1 Dissecting forceps

54

**HSB 006-10**  
1 Schere  
1 Microscopic scissors

33

**HWP 026-10**  
1 Knopfsonde, 1 mm Ø  
1 Probe, 1 mm Ø

69

**HSB 732-35**  
1 Skalpell, Holzheft  
1 Scalpel, dissecting

85

**HSC 550-10**  
1 Pinzette  
1 Dissecting forceps

63

**HSO 102-01**  
1 Präparier-Nadel  
1 Dissecting needle

71

**HWP 029-10**  
1 Knopfsonde, 1 mm Ø  
1 Probe, 1 mm Ø

69

**HSB 733-40**  
1 Skalpell, Holzheft  
1 Scalpel, dissecting

85

**HSK 256-03**  
1 Meißel  
1 Chisel

71

**HSO 104-03**  
1 Präparier-Lanzette  
1 Dissecting lancet

71



**HSO 119-00**

Basis Tierexperimentier-Set, enthaltend:  
Basic animal experiments set, containing:

**HSB 010-10**

105 mm  
Schere für Mikroskopie, gerade  
Microscopic scissors, straight

34

**HSB 500-09**

90 mm  
Mikroschere  
Micro-scissors

29

**HSB 705-11**

fig. 11  
Skalpellklingen, 10 Stück  
Scalpel blades, 10 pieces

83

**L-HSB 805-03**

125 mm  
Skalpellgriff, No. 3  
Scalpel handle, NO. 3

83

**HSC 552-11**

115 mm  
Mikroskopische Pinzetten, gerade  
Microscopic forceps, straight

63

**HSD 009-14**

Mathieu  
140 mm  
Nadelhalter  
Needle holder

78

**HSE 004-35**

35 mm  
Gefäßklemmen, gerade, 2 Stück  
Serrefines, straight, 2 pieces

75

**HSM 076-10**

105 mm  
Hautzängchen und feines Knochenzängchen  
Cuticle nippers and delicate bone cutting forceps

99

34 = Einzelabbildung - Seite 34  
= Single illustration - page 34

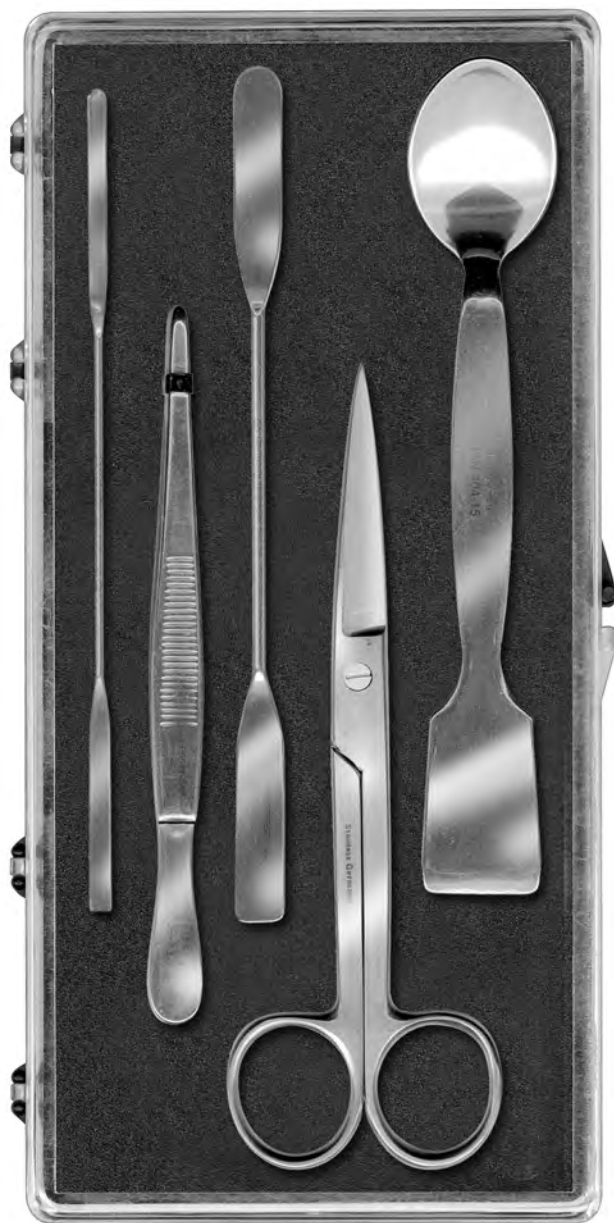

**HSO 125-00**

Kleines Chemikerbesteck, 5-tlg., enthaltend:  
Small chemist's set, 5 pieces, containing:

**HSN 022-15**

150 mm  
I Mikro-Pulverspatel, flexibel  
I Micro-powder-spatula, flexible

12

**HSN 404-15**

150 mm  
I Löffelspatel, 32x22 mm (SLxSB)  
I Spoon-spatula, 32x22 mm (SLxSB)

27

**HSN 068-15**

150 mm  
I Doppelspatel, flexibel  
I Spatula, double-ended, flexible

14

**HSC 809-13**

130 mm  
I Anatomische Pinzette,  
einfache Ausführung  
I Thump forceps, simple type

65

**HSB 954-14**

140 mm  
I Schere, spitz/spitz, gerade  
I Scissors, sharp/sharp, straight

47

12 = Einzelabbildung - Seite 12  
= Single illustration - page 12



**HSO 126-00**

Großes Chemikerbesteck, 9-tlg., enthaltend:  
Large chemist's set, 9 pieces, containing:

12 = Einzelabbildung - Seite 12  
= Single illustration - page 12

**HSN 007-13**

130 mm  
I Mikro-Doppelspatel, flexibel  
I Micro-spatula, double ended, flexible

12

**HSN 090-18**

185 mm  
I Doppelspatel, starr  
I Spatula, double ended, non-flexible

14

**HSN 412-17**

170 mm  
I Wägeschäufelchen, 10 x 40 mm (LB x LL)  
I Weighing scoop, 10 x 40 mm (LB x LL)

28

**HSN 061-15**

150 mm  
I Mikro-Löffelspatel, Löffel 5x7 mm  
I Micro-spoon-spatula, spoon 5x7 mm

13

**HSL 510-17**

170 mm  
I Schere, gerade, gezahnt  
I Scissors, straight, serrated

46

**HSN 068-15**

150 mm  
I Doppelspatel, breit, beidseitig rund  
I Spatula, wide type, both ends round

14

**HSN 034-18**

185 mm  
I Mikro-Pulverspatel, flexibel  
I Micro-powder-spatula, double ended, flexible

13

**HSN 168-18**

180 mm  
I Polylöffel  
I Polyspoon

27

**HSC 804-16**

160 mm  
I Pinzette, spitz, einfache Ausführung  
I Forceps, sharp, simple type

65



**HSO 128-00**

Biologenbesteck, 5-tlg., enthaltend:  
Biologist's set, 5 pieces, containing:

**HSC 188-13**

130 mm  
I Feine Präparierpinzette, gerade  
I Fine preparation forceps, straight

60

**HWO 008-14**

140 mm  
I Präpariernadel mit Plastikheft, gerade  
I Dissecting needle with plastic handle, straight

70

**HWO 072-20**

200 mm  
I Abstrichöse mit Plastikheft  
I Specimen loop with plastic handle

72

**HSB 731-30**

155 mm  
I Skalpell mit Holzgriff, Klinge 30 mm  
I Scalpel, wooden handle, blade 30 mm

85

**L-HSB 010-10**

105 mm  
I Schere für Mikroskopie, gerade  
I Microscopic scissors, straight

34

60 = Einzelabbildung - Seite 60  
= Single illustration - page 60

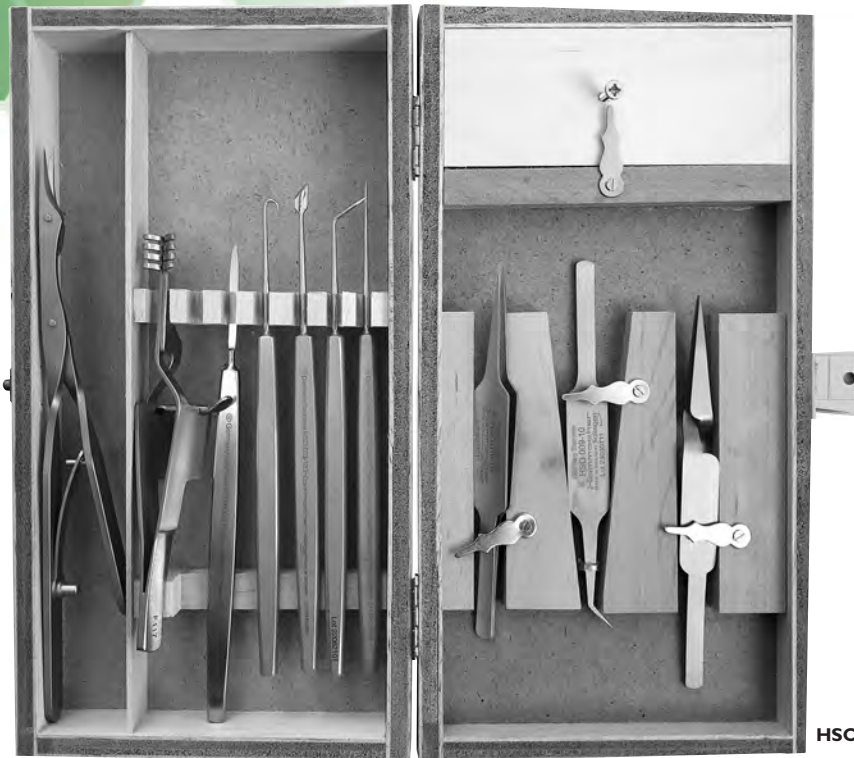

HSO 001-10



**HSO 006-10**  
100 mm  
Wundspreizer  
Retractor



**HSO 009-10**  
100 mm  
Feine spitze Pinzette, gebogen  
Micro dissecting forceps, curved



**HSO 010-10**  
100 mm  
gerade  
straight



**HSO 012-10**  
100 mm  
gekreuzt  
cross action



**HSB 800-12**  
125 mm  
Mikroskalpelle  
Micro scalpels



**HSO 003-12**  
125 mm  
Präpariermeißel  
Dissecting chisel



**HSO 004-13**  
130 mm  
fein  
fine



**HSO 005-13**  
130 mm  
hakenförmig  
hook shaped  
Mikropräpariernadel  
Dissecting needle



**HSO 007-13**  
130 mm  
gebogen  
angled



**HSO 008-15**  
150 mm  
Mikroskopierschere, gerade, extra fein  
Micro dissecting scissors, straight, extra fine

**HSO 001-10**

Mikroskopiebesteck, enthaltend:  
Micro-dissecting set, containing:

**HSB 800-12**  
125 mm  
Mikroskalpelle  
Micro scalpels

**HSO 003-12**  
125 mm  
Präpariermeißel  
Dissecting chisel

**HSO 004-13**  
130 mm  
Präpariernadel, fein  
Dissecting needle, fine

**HSO 005-13**  
130 mm  
Präpariernadel, hakenförmig  
Dissecting needle, hook shaped

**HSO 007-13**  
130 mm  
Präpariernadel, gebogen  
Dissecting needle, angled

**HSO 006-10**  
100 mm  
Wundspreizer  
Retractor

**HSO 008-15**  
150 mm  
Mikroskopierschere, gerade, extra fein  
Micro dissecting scissors, straight, extra fine

**HSO 009-10**  
100 mm  
Feine spitze Pinzette, gebogen  
Micro dissecting forceps, curved

**HSO 010-10**  
100 mm  
Feine spitze Pinzette, gerade  
Micro dissecting forceps, straight

**HSO 012-10**  
100 mm  
Feine spitze Pinzette, gekreuzt  
Micro dissecting forceps, cross action



**HSO 130-00**

Studentenbesteck 7 teilig, einfache Ausführung, Inhalt:  
Set for students, 7 pieces, simple type, contents:

83 = Einzelabbildung - Seite 83  
= Single illustration - page 83

**L-HSB 805-03**

1 Skalpellgriff Nr. 3  
1 scalpel handle No. 3

83

**HSC 801-11**

1 feine spitze Pinzette  
1 preparations scissors

65

**HSB 704-10 + HSB 707-15**

je 5 Stück sterile Skalpellklingen Fig. 10 und 15  
5 pieces each of sterile scalpel blades Fig. 10 and 15

83

**HSO 104-03**

1 Lanzettenpräpariernadel  
1 lancet dissection needle

71

**HSB 942-11**

1 Präparierschere  
1 preparations scissors

47

**HSO 102-01**

1 Präpariernadel  
1 dissection needle

71

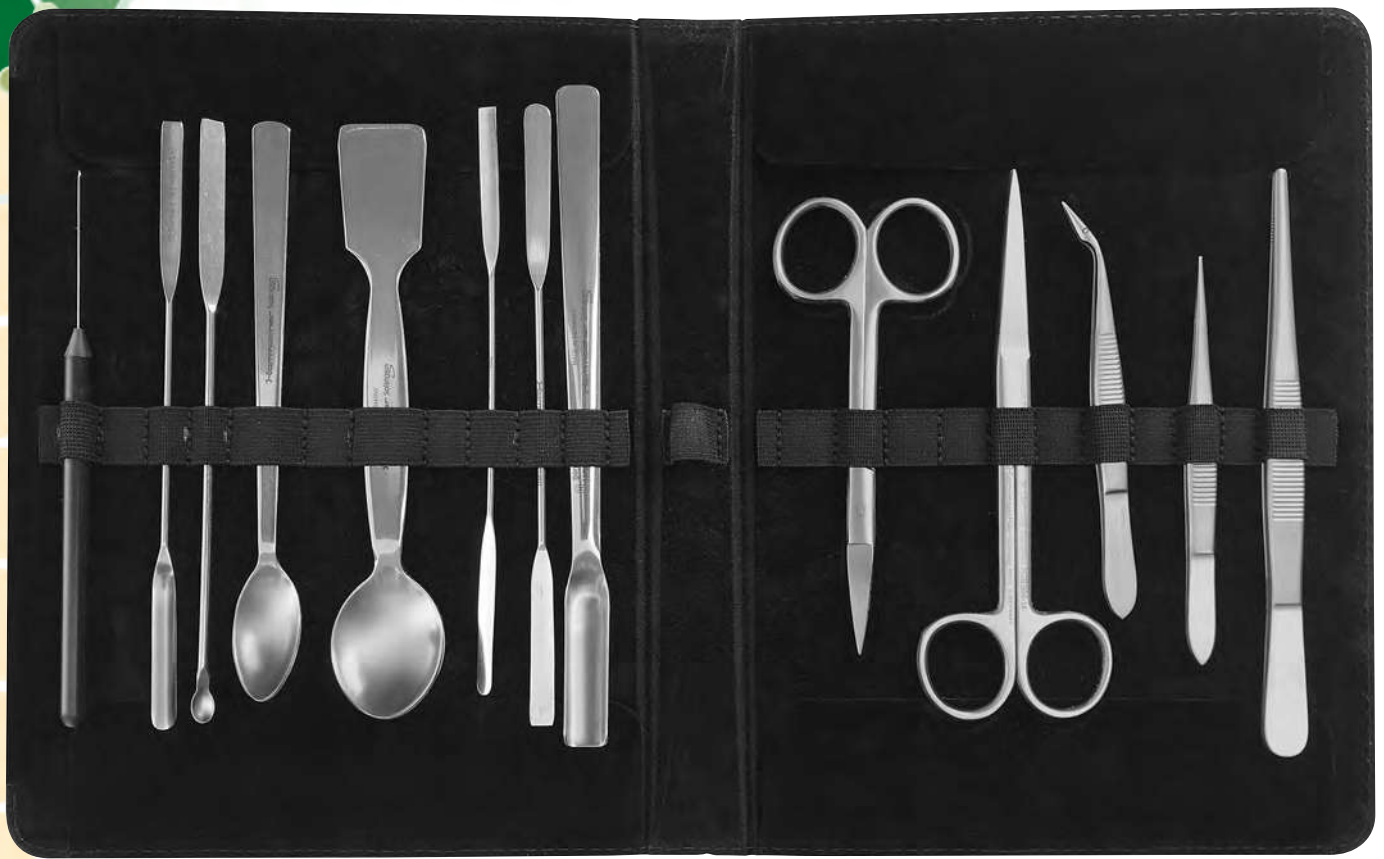
**HSO 131-00**

Chemikerbesteck, 13-teilig im Kunststofftui mit Reißverschluss, enthaltend:  
Chemist's set, 13 pieces in a plastic case with a zipper, containing:

**HSL 531-01**

Kunststofftui mit Reißverschluss, leer  
Plastic case with a zipper, empty

**HSN 028-15**

Mikro-Doppelspatel, flexibel, 150 mm  
Micro spatula, double-ended, flexible, 150 mm

12

**HSN 037-15**

Mikro-Doppelspatel, flexibel, 150 mm  
Micro spatula, double-ended, flexible, 150 mm

13

**HSN 404-15**

Löffelspatel, 150 mm  
Spoon spatula, 150 mm

27

**HSN 061-15**

Mikro-Löffelspatel, 150 mm, Löffel 5 x 7 mm  
Micro spoon spatula, 150 mm, spoon 5 x 7 mm

13

**HSN 412-17**

Wäge-Schäufelchen, 170 mm, 10 x 40 mm  
Weighing scoop, 170 mm, 10 x 40 mm

28

**HSN 043-15**

Mikro-Pulverspatel, flexibel, 150 mm  
Micro powder spatula, flexible, 150 mm

13

**HSO 102-01**

Präpariernadel, gerade, 140 mm,  
mit Kunststoffgriff  
Dissecting needle, straight, 140 mm,  
with plastic handle

71

**HSN 159-15**

Apothekerlöffel, 150 mm  
Chemists spoon, 150 mm

26

**HSC 197-10**

Splitterpinzette, Hunter, gebogen, 105 mm  
Splinter forceps, Hunter, curved, 105 mm

60

**HSC 810-14**

Pinzette, anatomisch, 145 mm, einfache Ausführung  
Thumb forceps, 145 mm, simple type

65

**HSC 800-10**

Pinzette, 105 mm, spitz, gerade, einfache Ausführung  
Forceps, 105 mm, sharp, straight, simple type

65

**HSB 942-11**

Schere für Mikroskopie, 115 mm, gerade, einfache Ausführung  
Microscopic scissors, 115 mm, straight, simple type

47

**HSB 954-14**

Schere, Standard, gerade, spitz/spitz, 145 mm,  
einfache Ausführung  
Scissors, standard, straight, sharp/sharp, 145 mm,  
simple type

47

12

= Einzelabbildung - Seite 12  
= Single illustration - page 12



**HSO 132-00**

Löffel- und Spatelset, 14-teilig im Kunststofftui mit Reißverschluss, enthaltend:  
Spoon and spatula set, 14 pieces in a plastic case with a zipper, containing:

**HSL 531-01**

Kunststofftui mit Reißverschluss, leer  
Plastic case with a zipper, empty

**HSN 404-15**

Löffelspatel, 150 mm  
Spoon spatula, 150 mm

27

**HSN 405-18**

Löffelspatel, 180 mm  
Spoon spatula, 180 mm

27

**HSN 060-10**

Mikro-Löffelspatel, 100 mm,  
Löffel 5 x 7 mm  
Micro spoon spatula, 100 mm,  
spoon 5 x 7 mm

13

**HSN 061-15**

Mikro-Löffelspatel, 150 mm,  
Löffel 5 x 7 mm  
Micro spoon spatula, 150 mm,  
spoon 5 x 7 mm

13

**HSN 062-18**

Mikro-Löffelspatel, 185 mm,  
Löffel 5 x 7 mm  
Micro spoon spatula, 185 mm,  
spoon 5 x 7 mm

13

**HSN 088-13**

Doppelspatel, starr, 130 mm  
Spatula, double-ended, rigid, 130 mm

14

**HSN 089-15**

Doppelspatel, starr, 150 mm  
Spatula, double-ended, rigid, 150 mm

14

**HSN 090-18**

Doppelspatel, starr, 185 mm  
Spatula, double-ended, rigid, 185 mm

14

**HSN 043-15**

Mikro-Pulverspatel, flexibel, 150 mm  
Micro powder spatula, flexible, 150 mm

13

**HSN 160-17**

Apothekerlöffel, doppelendig, 170 mm  
Chemists spoon, double-ended, 150 mm

26

**HSN 153-15**

Chemikalienlöffel, doppelseitig, 150 mm  
Spoon for chemicals, double-ended, 150 mm

26

**HSN 412-17**

Wäge-Schäufelchen, 170 mm, 10 x 40 mm  
Weighing scoop, 170 mm, 10 x 40 mm

28

**HSN 047-13**

Mikro-Pulverspatel, löffelförmig, 130 mm  
Micro powder spatula, spoon shaped, 130 mm

13

**HSN 048-15**

Mikro-Pulverspatel, löffelförmig, 130 mm  
Micro powder spatula, spoon shaped, 130 mm

13

27

= Einzelabbildung - Seite 27  
= Single illustration - page 27



**HWM 064-00**  
50 x 100 mm

**HWM 065-00**  
50 x 130 mm  
StandgefäÙe ohne Deckel  
Jars without lid



**HWM 083-00**  
170 x 100 x 35 mm

**HWM 084-00**  
250 x 140 x 40 mm

**HWM 085-00**  
275 x 150 x 45 mm  
Nierenschalen  
Kidney bowls



**HWM 087-10**  
10 cl  
MeÙbecher, graduiert  
Measuring cup, graduated

*Inhalt 10 cl  
Volume 10 cl*



**HWM 088-25**  
25 cl  
MeÙbecher, graduiert  
Measuring cup, graduated

*Inhalt 25 cl  
Volume 25 cl*

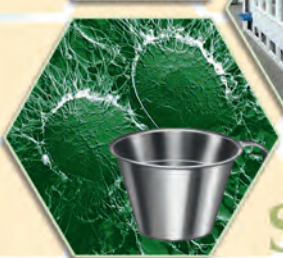

Solingen



**HSM 060-00**  
160 ml  
Anmischbecher aus Silikon  
Mixing bowl from silicone



**HSL 128-00**  
Flexibler Anmischbecher, klein  
Flexible mixing bowl, small



**HSL 740-00**  
7 x 5,5 cm  
Einweg-Anmischpalette  
(1 VE = 10 Stück)  
Disposable mixing pallet  
(1 unit = 10 pieces)

*Hohlmeißelzangen mit feinen Arbeitsenden zur Verwendung in schwer zugänglichen Bereichen  
Bone rongeurs with small beaks for use in limited-access areas.*



**HSM 004-14**  
140 mm  
rostfrei  
stainless

Pedikürezeange  
Pedicure nail nippers



**L-HSK 480-01  
Mini-Friedman**  
150 mm  
Hohlmeißelzange, gerade  
Rongeur, straight



**L-HSK 481-01  
Mini-Friedman**  
150 mm  
Hohlmeißelzange, 45° gebogen  
Rongeur, 45° curved



**HSM 012-11**  
110 mm  
rostfrei  
stainless



**HSM 015-13**  
130 mm  
rostfrei  
stainless



**HSM 022-12**  
120 mm

**HSM 025-13**  
130 mm  
rostfrei  
stainless



**HSM 031-12**  
115 mm

**HSM 034-13**  
130 mm  
rostfrei  
stainless



**HSM 076-10**  
105 mm

**HSM 079-11**  
115 mm  
rostfrei  
stainless

Knochensplitter- und Pufferzangen  
Bone cutting forceps / Nail nippers

Nagelzange  
Nail nipper

Haut- und Knochenzängchen  
Fine cuticle and bone cutting forceps



**HSM 081-11**  
110 mm  
Gewebezängchen, rostfrei,  
Schneide 5 mm, extra spitz  
Tissue forceps, stainless,  
5 mm, extra sharp



**HSM 009-11**  
115 mm  
Universalzange  
Universal forceps



**HSM 084-09**  
90 mm  
Gewebeschere, gebogen, spitz/spitz  
• Aufgrund der anatomischen Gestaltung der Griffe sowohl für Rechts- wie auch Linkshänder geeignet.

Tissue scissors, curved, sharp/sharp  
• Due to the anatomical design of the handles suitable both for right and left handed.



**HWM 200-11**  
Nagelreiniger und -feile  
Nail cleaner and file



**HWM 201-09**  
90 mm  
Nagelschere, gebogen  
Nail scissors, curved

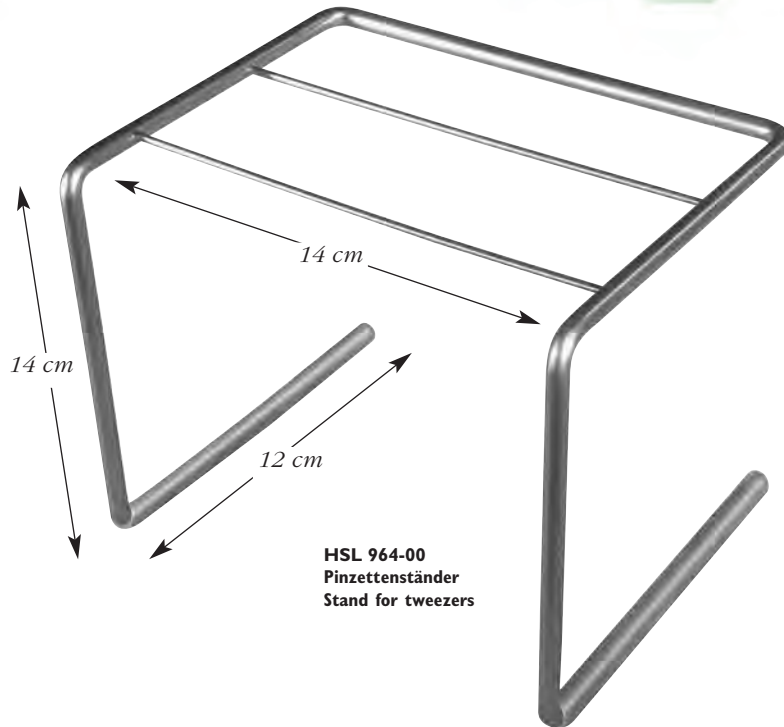

HSL 964-00  
Pinzettenständer  
Stand for tweezers

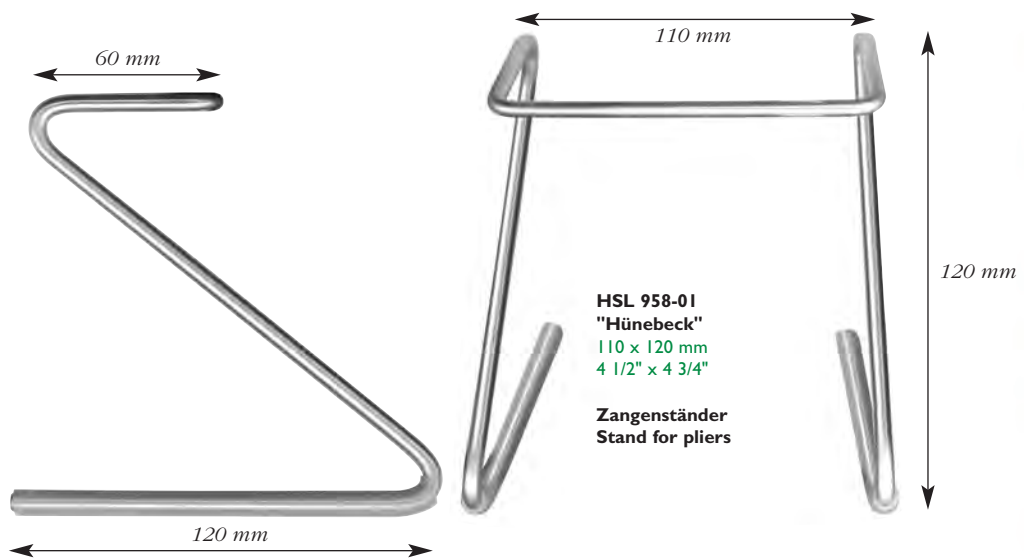

HSL 958-01  
"Hünebeck"  
110 x 120 mm  
4 1/2" x 4 3/4"  
Zangenständer  
Stand for pliers

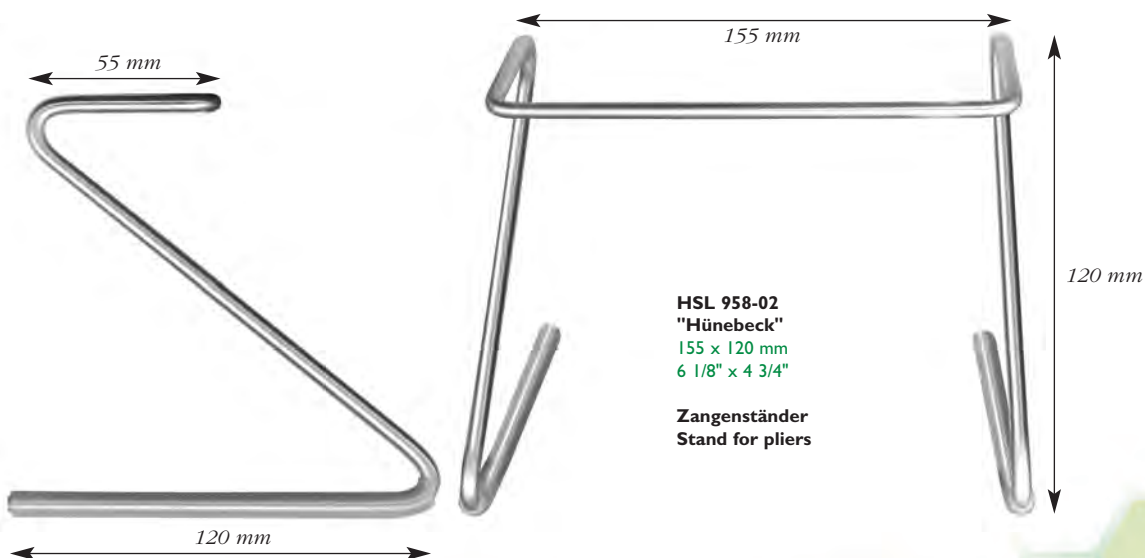

HSL 958-02  
"Hünebeck"  
155 x 120 mm  
6 1/8" x 4 3/4"  
Zangenständer  
Stand for pliers

**HSL 966-00**

155 × 55 × 35 mm

Reagenzglasständer für 12 Reagenzgläser in mattierter Ausführung  
Test tube rack for 12 test tubes in a satin finish

**HSL 967-00**

155 × 55 × 60 mm

Reagenzglasständer für 12 Reagenzgläser in mattierter Ausführung  
Test tube rack for 12 test tubes in a satin finish

**HSL 968-00**

160 × 55 × 90 mm

Reagenzglasständer für 12 Reagenzgläser in mattierter Ausführung  
Test tube rack for 12 test tubes in a satin finish



**HSB 779-13**  
135 mm  
Kugelschreiber mit Diamant  
zum Schreiben auf Glas  
Pencil with pin of diamond  
for writing on glass



**HSB 780-01**  
145 mm  
Schreibdiamant zum  
Schreiben auf Glas,  
Holzgriff, Diamant  
Größe I  
Diamond for writing  
on glass, wooden  
handle, Diamond  
size I



**HSL 678-00**  
*fig. 0*

**HSL 679-01**  
*fig. 1*

**HSL 680-02**  
*fig. 2*

**HSL 681-03**  
*fig. 3*  
Sägeblätter für Metall  
Saw blades for metal

**HSL 684-01**  
*fig. 1*

**HSL 685-02**  
*fig. 2*

**HSL 686-03**  
*fig. 3*  
Sägeblätter für Gips  
Saw blades for plaster



**HSL 670-12**  
0,12 x 5 mm



**HSL 671-25**  
0,25 x 5 mm



**HSL 672-25**  
0,25 x 3 mm



**HSL 673-12**  
0,12 x 2,8 mm  
Modellsägeblätter, schnellschneidend und biegefest  
Saw blades, quick cutting with high flexural strength  
*Verpackungseinheit: 24 Stück*  
Standard package: 24 pcs

*spitz  
pointed*



**HSL 660-21**  
210 mm  
Niethammer, Normalstahl mit Holzstiel  
Riveting hammer, Normal steel, wooden handle



**HSL 676-00**  
Laubsägebogen, verstellbar mit Holzheft  
Fret saw frames, adjustable  
with wooden handle



**HSL 668-20**  
200 mm  
Modellsäge  
Model saw



**HSL 669-18**  
180 mm  
Abgewinkelte Säge  
Bowed model saw



**L-HSJ 130-03**  
fig. 3  
20 mm

**L-HSJ 139-03**  
fig. 3  
20 mm

**L-HSJ 146-04**  
fig. 4  
22 mm

**L-HSJ 149-03**  
fig. 3  
20 mm

**L-HSJ 131-04**  
fig. 4  
22 mm

**L-HSJ 140-04**  
fig. 4  
22 mm

**L-HSJ 147-05**  
fig. 5  
24 mm

**L-HSJ 150-04**  
fig. 4  
22 mm

**L-HSJ 132-05**  
fig. 5  
24 mm  
hohl, vergrößernd  
magnifying

**L-HSJ 141-05**  
fig. 5  
24 mm

**L-HSJ 147-05**  
fig. 5  
24 mm  
Rhodium Front,  
hohl, vergrößernd  
magnifying, front  
surface

**L-HSJ 151-05**  
fig. 5  
24 mm  
Rhodium Front, plan,  
nicht vergrößernd  
Front surface, plane,  
not magnifying

Spiegel, VE = 12 Stück  
Mirrors, Packunit = 12 pcs.



**HSJ 116-00**  
130 mm

Griff für Spiegel und Sondeneinsätze  
für Studenten mit der Möglichkeit zur  
Aufbewahrung von Bohrnern, Feilen  
usw. im Ende des Griffes  
Handle for mirrors and probe inserts  
for students with the possibility of  
storing drills, files etc. in the end of  
the handle



**L-HWJ 091-00**  
hohl  
hollow



**L-HSJ 101-00**  
hohl, mit PVD-  
Beschichtung  
hollow, with PVD-  
coating



**L-HSJ 102-00**  
massiv  
solid

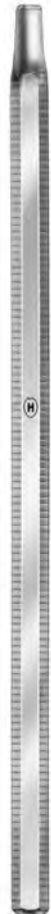

**L-HSJ 103-00**  
massiv  
solid



**L-HSJ 106-00**  
hohl  
hollow



**L-HSJ 109-01**  
hohl, matt  
hollow, satin-  
finished



**L-HSR 550-00**  
mit PPSU-Griff, sterilisierbar  
with PPSU handle,  
sterilizable



28 mm

**HSK 069-03**  
Ø 3 mm

**HSK 069-04**  
Ø 4 mm

**HSK 069-05**  
Ø 5 mm

**HSK 069-06**  
Ø 6 mm

Grazile Stanzen  
Delicate punches

Mehr Kontrolle  
+ mehr Gefühl  
- da manuell geführt !  
Better control  
+ better sensibility  
- as manually used !

Spiegelgriffe  
Mirror handles



**HSZ 997-12**  
12 ml

**Ölstift**

- synthetisches Pflegeöl
- dampfdurchlässig und hochtemperaturstabil bis 260° C
- geruchslos, transparent und silikonfrei
- hinterlässt keine braunen Verfärbungen auf den Instrumenten
- punktgenaue Dosierung durch das Sicherheits- / Anti-Tropf-Ventil

**Oil pen**

- synthetic maintenance oil
- vapour permeable and high temperature stability up to 260 ° C
- odourless, transparent and free of silicone
- does not leave any brown stains on the instruments
- precise dosage by the safety / anti-drip valve



**HSS 001-00**  
2,8 x 19,0 mm  
Spitzenschutz, Silikon, grün  
(1 VE = 100 Stück)  
Tip protection, silicone, green  
(1 unit = 100 pcs.)



**HSS 002-00**  
3,2 x 25,4 mm  
Spitzenschutz, Silikon, pink  
(1 VE = 100 Stück)  
Tip protection, silicone, pink  
(1 unit = 100 pcs.)



**HSS 003-00**  
5,0 x 25,0 mm  
Spitzenschutz, Silikon, gelb  
(1 VE = 100 Stück)  
Tip protection, silicone, yellow  
(1 unit = 100 pcs.)



**HSS 004-00**  
2,0 x 9,0 x 25,0 mm  
Spitzenschutz, Silikon, orange  
(1 VE = 100 Stück)  
Tip protection, silicone, orange  
(1 unit = 100 pcs.)



**HSS 005-00**  
2,0 x 16,0 x 25,0 mm  
Spitzenschutz, Silikon, braun  
(1 VE = 100 Stück)  
Tip protection, silicone, brown  
(1 unit = 100 pcs)



**HSS 006-00**  
25,0 x 25,0 mm  
Spitzenschutz, Silikon, orange  
(1 VE = 50 Stück)  
Tip protection, silicone, orange  
(1 unit = 50 pcs)

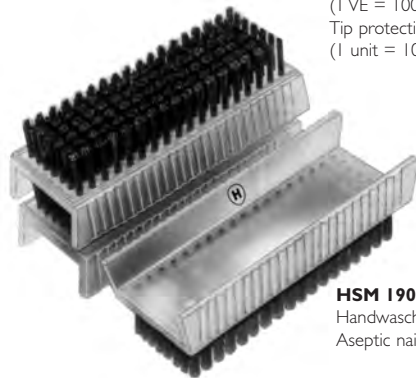

**HSM 190-01**  
Handwaschbürste  
Aseptic nailbrush



**HSM 191-00**  
Sterilisierbare Kunststoffbürste  
Sterilizable plastic brush

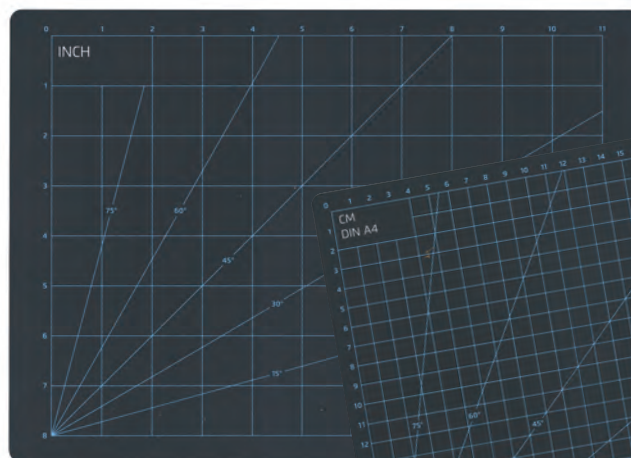

**HSM 231-23**  
Schneidmatte 230 x 320 mm mit Rasteraufdruck  
Cutting mat 230 x 320 mm with grid print



**HSM 230-14**  
Schneidmatte 148 x 210 mm  
Cutting mat 148 x 210 mm



**HSM 220-00**

Sicherheitsbehälter für Sondermüll und gebrauchte Nadeln  
Safety container for special waste and used needles

- einfaches Schnappmontagesystem
- System zur Teilöffnung
- große Öffnung zur Entnahme sperriger Gegenstände
- Anzeige für maximalen Füllstand
- keine Emission schädlicher Gase bei der Verbrennung
- vorübergehender und endgültiger Verschluss
- easy snap assembly system
- partial opening system
- wide opening for the removal of bulky objects
- indicator for maximum level of filling
- no emission of harmful gases during incineration
- temporary and final closure



**HSM 221-00**

Saugplatte für HSM 220-00 mit rutschfester Saugnapfbasis  
Suction plate for HSM 220-00 with a non-slip suction cup base



**HSM 222-18**

Kunststoffspatel aus Polyamid für Zement und Acryl, autoklavierbar  
(1 VE = 10 Stck)  
Plastic polyamide spatula for cement and acrylic, autoclavable  
(1 pack. = 10 pcs.)



**HSM 223-00**

Glasmörser für Acryl mit Kunststoffdeckel und Stößel,  
Durchmesser 10 cm  
Glass mortar for acrylic with plastic cover and pestle,  
diameter 10 cm



18-20 mm

**HSL 750-00**  
150 x 75 mm  
Glasblock  
Glass slab



5-6 mm

**HSL 751-00**  
95 x 70 mm  
Glasplatte  
Glass slab



**HSL 252-15**  
15 cm / 6 inch

**HSL 252-20**  
20 cm / 8 inch

rostfrei / sterilisierbar  
stainless / sterilizable

**Messlineale aus Metall**  
Measuring ruler of metal

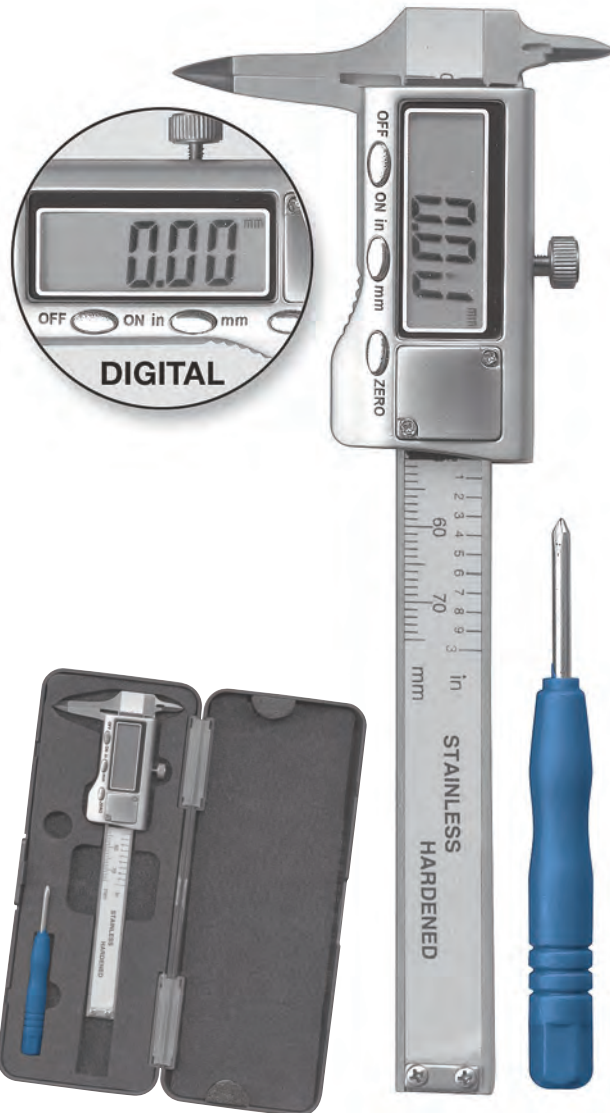

**HSL 246-15**  
**Digital-Taschen-Messschieber**  
**Digital pocket caliper**

- mit schmal geformten Messschenkeln
- mit Kreuzspitzen und Tiefenmessstab
- aus rostfreiem Stahl, gehärtet
- extra große Anzeige, Ablesung 0,01 mm / .0005"; umschaltbar
- Schalter ein / aus, DIN 862, Metallgehäuse, inkl. Etui, ohne Antriebsrolle
- Messbereich: 70 mm / Schnabellänge: 20 mm

- with slim measuring parts
- with cross peaks and depth gauge
- made of stainless steel, hardened
- jumbo display, reading 0,01 mm / .0005"; switchable
- switch on / off, DIN 862, metal casing, incl. wallet, without driving roller
- measuring range: 70 mm / jaws: 20 mm



**HSN 300-00**  
Ø 55 x 80 mm  
ca. 120 ccm  
Spirituslampe, rostfrei  
Alcohol burners, stainless steel

**HSN 301-04**  
Ø 4 mm  
Ersatzdocht, rund, per meter  
Spare wicks, round, one meter



**HSN 302-00**  
Ø 65 x 75 mm  
ca. 75 ccm  
Spirituslampe, rostfrei  
Alcohol burners, stainless steel

**HSN 303-12**  
12 mm breit  
Ersatzdocht, flach, per meter  
Spare wicks, flat, one meter

Alle Propellerrührköpfe auch mit anderem Gewinde zu erhalten!  
All propeller stirring heads are also available with a different thread!



**HSN 801-05**  
Rührfläche Ø 55 mm, Gewinde M6  
Stirring area Ø 55 mm, Thread M6

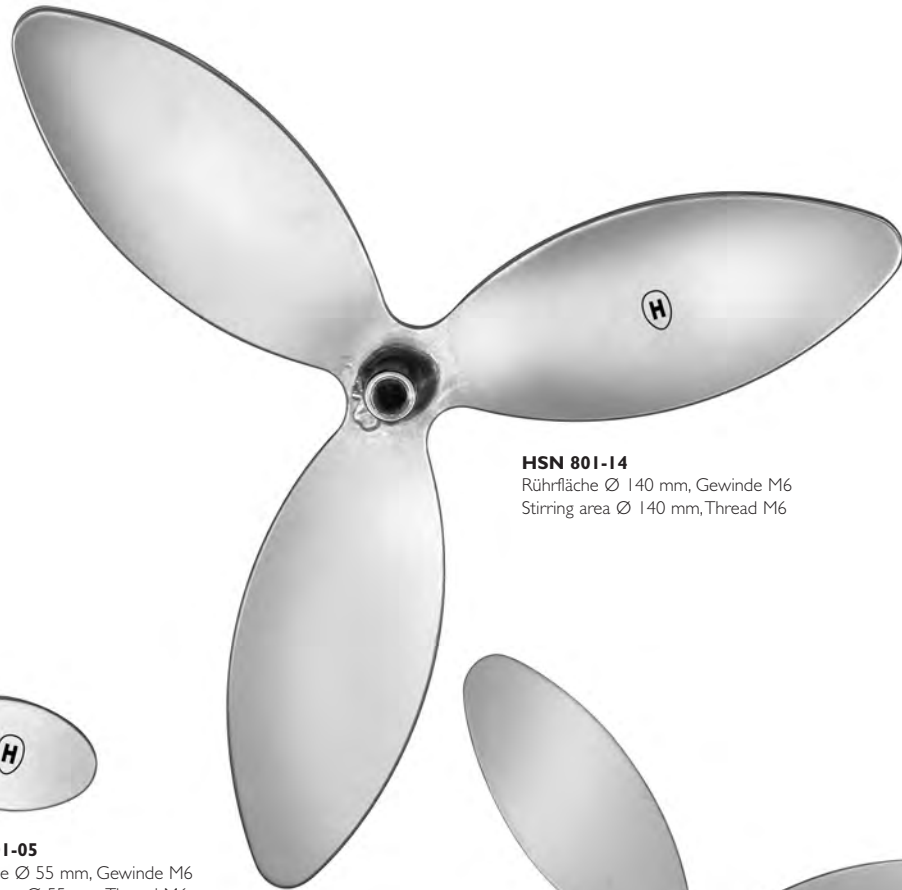

**HSN 801-14**  
Rührfläche Ø 140 mm, Gewinde M6  
Stirring area Ø 140 mm, Thread M6

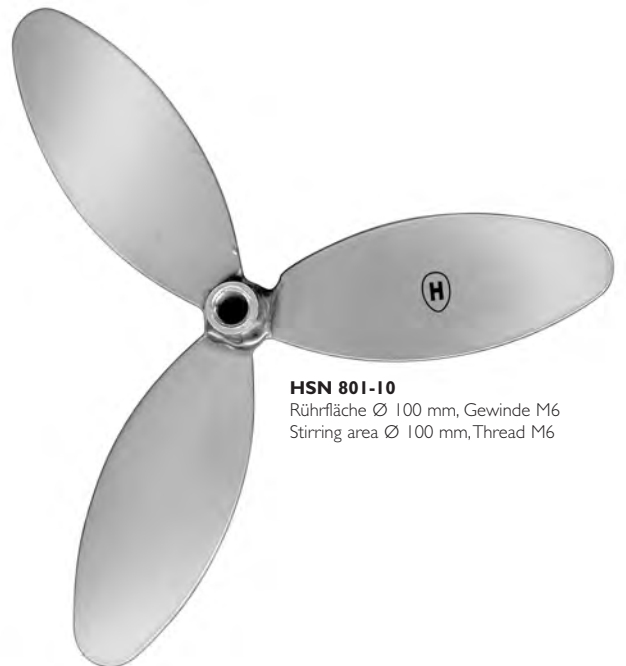

**HSN 801-10**  
Rührfläche Ø 100 mm, Gewinde M6  
Stirring area Ø 100 mm, Thread M6



**HSN 801-07**  
Rührfläche Ø 70 mm, Gewinde M6  
Stirring area Ø 70 mm, Thread M6

**HSN 826-01**

Stativringe  
 Ø Material: 8 mm  
 Länge: 220 mm  
 Ø Ring: 50 mm

Stand rings  
 Ø Material: 8 mm  
 Length: 220 mm  
 Ø Ring: 50 mm

**HSN 826-05**

Stativringe  
 Ø Material: 8 mm  
 Länge: 220 mm  
 Ø Ring: 160 mm

Stand rings  
 Ø Material: 8 mm  
 Length: 220 mm  
 Ø Ring: 160 mm

**HSN 830-01**

Hakenmuffe – Edelstahl 4301/4308 – Spannweite 13 mm  
 Hook sleeve – stainless steel 4301/4308 – capacity 13 mm

**HSN 823-01**

Stativklammer, rund, rostfrei CrNi 18/8  
 Stand clamps, round, stainless CrNi 18/8

Spannweite: 25 mm, Länge: 150 mm  
 Spread: 25 mm, length: 150 mm



Ø 12 mm

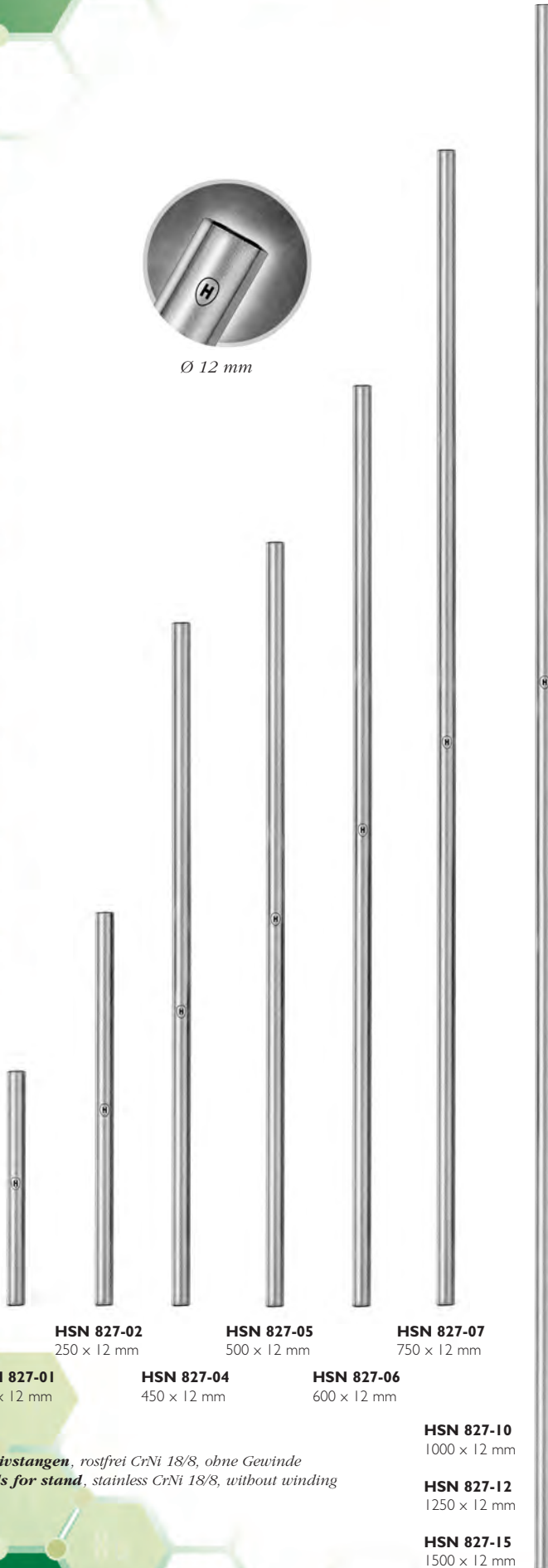

**HSN 827-01**  
150 x 12 mm

**HSN 827-02**  
250 x 12 mm

**HSN 827-04**  
450 x 12 mm

**HSN 827-05**  
500 x 12 mm

**HSN 827-06**  
600 x 12 mm

**HSN 827-07**  
750 x 12 mm

**HSN 827-10**  
1000 x 12 mm

**HSN 827-12**  
1250 x 12 mm

**HSN 827-15**  
1500 x 12 mm

**Stativstangen**, rostfrei CrNi 18/8, ohne Gewinde  
**Rods for stand**, stainless CrNi 18/8, without winding

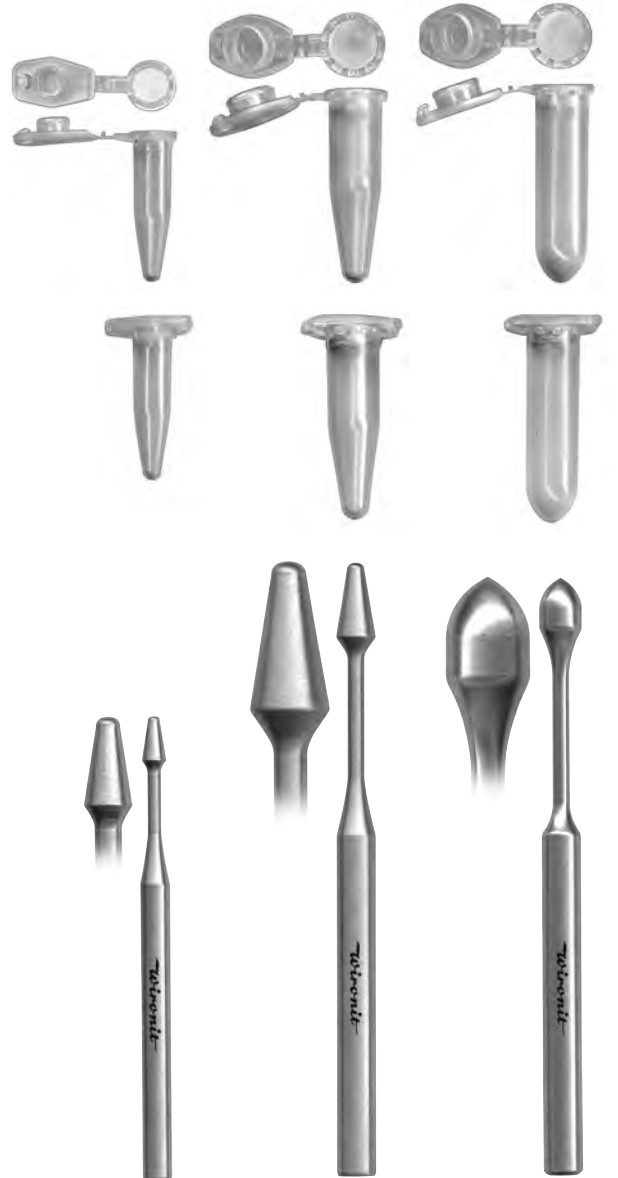

**HWO 100-05**  
94 mm / 0,5 mm

**HWO 101-15**  
124 mm / 1,5 mm

**HWO 102-20**  
120 mm / 2,0 mm

Mikropistill zum Homogenisieren von Zellen, Geweben, usw.  
Micro pestle for homogenizing cells, tissues, etc.

Katalog-Nr. Cat. No.	Abb. auf Seite Illustr. on page	Katalog-Nr. Cat. No.	Abb. auf Seite Illustr. on page	Katalog-Nr. Cat. No.	Abb. auf Seite Illustr. on page	Katalog-Nr. Cat. No.	Abb. auf Seite Illustr. on page
HSB 004-09	33	HSB 124-18	39	HSB 707-15	83	HSB 952-12	47
HSB 005-09	33	HSB 125-18	39	HSB 709-20	84	HSB 952-16	47
HSB 006-10	33	HSB 126-14	39	HSB 710-21	84	HSB 954-14	47
HSB 007-10	33	HSB 127-14	39	HSB 711-32	84		
HSB 008-13	33	HSB 128-18	39	HSB 712-23	84	<b>HSC</b>	
HSB 010-10	34	HSB 129-18	39	HSB 713-24	84	HSC 001-01	57
HSB 011-10	34	HSB 138-14	40	HSB 714-25	84	HSC 012-05	57
HSB 012-11	34	HSB 284-09	40	HSB 730-25	85	HSC 020-05	64
HSB 013-11	34	HSB 287-11	40	HSB 731-30	85	HSC 021-09	64
HSB 014-11	34	HSB 300-11	41	HSB 732-35	85	HSC 030-15	57
HSB 0140-11	43	HSB 301-11	41	HSB 733-40	85	HSC 031-15	57
HSB 0141-11	43	HSB 306-14	41	HSB 734-45	85	HSC 045-14	64
HSB 015-11	34	HSB 310-14	41	HSB 746-00	86	HSC 048-10	54
HSB 018-11	34	HSB 314-14	41	HSB 747-01	86	HSC 050-11	54
HSB 019-11	34	HSB 316-14	41	HSB 748-02	86	HSC 052-13	54
HSB 020-11	34	HSB 317-14	41	HSB 750-00	86	HSC 054-14	54
HSB 021-11	34	HSB 324-14	41	HSB 751-01	86	HSC 056-16	54
HSB 022-12	35	HSB 325-14	41	HSB 752-02	86	HSC 058-18	54
HSB 023-12	35	HSB 390-10	42	HSB 756-06	86	HSC 060-20	54
HSB 028-15	35	HSB 391-10	42	HSB 779-13	103	HSC 062-25	54
HSB 029-15	35	HSB 392-11	42	HSB 780-01	103	HSC 064-30	54
HSB 030-16	35	HSB 393-11	42	HSB 782-00	87	HSC 072-13	57
HSB 031-16	35	HSB 395-13	42	HSB 782-99	87	HSC 073-13	57
HSB 033-16	35	HSB 396-13	42	HSB 783-00	87	HSC 074-14	57
HSB 046-11	35	HSB 397-13	42	HSB 783-99	87	HSC 080-12	58
HSB 047-11	36	HSB 400-14	43	HSB 784-00	87	HSC 081-15	58
HSB 048-13	36	HSB 401-14	43	HSB 784-99	87	HSC 082-12	51
HSB 049-13	36	HSB 402-16	43	HSB 785-00	88	HSC 083-15	51
HSB 050-00	45	HSB 403-16	43	HSB 785-99	88	HSC 086-12	58
HSB 051-13	36	HSB 412-13	43	HSB 786-01	88	HSC 087-12	58
HSB 051-20	45	HSB 422-13	43	HSB 786-02	88	HSC 088-15	58
HSB 064-14	40	HSB 423-13	43	HSB 786-99	88	HSC 089-15	58
HSB 065-14	40	HSB 500-09	29	HSB 803-03	86	HSC 126-18	60
HSB 068-17	40	HSB 504-10	29	HSB 805-03	83	HSC 128-15	58
HSB 069-17	40	HSB 515-09	29	HSB 808-16	83	HSC 129-20	58
HSB 070-11	37	HSB 516-09	29	HSB 809-16	83	HSC 138-20	60
HSB 071-11	38	HSB 520-12	29	HSB 815-10	83	HSC 180-08	60
HSB 072-13	37	HSB 530-08	29	HSB 816-11	83	HSC 182-09	60
HSB 073-13	38	HSB 531-08	29	HSB 817-12	83	HSC 184-10	60
HSB 074-14	37	HSB 534-08	29	HSB 818-15	83	HSC 185-10	60
HSB 075-14	38	HSB 535-08	29	HSB 819-15	83	HSC 186-11	60
HSB 076-15	37	HSB 544-09	30	HSB 820-04	84	HSC 187-11	60
HSB 077-15	38	HSB 545-09	30	HSB 828-20	84	HSC 188-13	60
HSB 078-16	37	HSB 546-11	30	HSB 829-21	84	HSC 189-13	60
HSB 079-16	38	HSB 547-11	30	HSB 830-22	84	HSC 190-14	60
HSB 080-18	37	HSB 554-14	31	HSB 831-23	84	HSC 191-14	60
HSB 081-18	38	HSB 555-14	31	HSB 832-24	84	HSC 192-08	60
HSB 084-11	37	HSB 556-18	31	HSB 833-25	84	HSC 196-10	60
HSB 085-11	38	HSB 557-18	31	HSB 839-00	83	HSC 197-10	60
HSB 086-13	37	HSB 579-21	45	HSB 840-14	85	HSC 214-13	62
HSB 087-13	38	HSB 581-11	44	HSB 853-19	85	HSC 215-13	62
HSB 088-14	37	HSB 583-14	44	HSB 896-10	85	HSC 216-14	62
HSB 089-14	38	HSB 585-18	44	HSB 897-11	85	HSC 217-14	62
HSB 090-15	37	HSB 589-18	45	HSB 898-12	85	HSC 230-12	59
HSB 091-15	38	HSB 591-13	44	HSB 899-15	85	HSC 231-15	59
HSB 092-16	37	HSB 593-15	44	HSB 910-14	84	HSC 232-12	51
HSB 093-16	38	HSB 595-13	44	HSB 913-20	84	HSC 233-15	51
HSB 094-18	37	HSB 596-20	44	HSB 921-03	84	HSC 234-12	59
HSB 095-18	38	HSB 597-13	45	HSB 925-05	84	HSC 238-12	59
HSB 098-11	37	HSB 601-18	44	HSB 927-06	84	HSC 239-12	59
HSB 099-11	38	HSB 602-14	44	HSB 929-07	84	HSC 240-15	59
HSB 100-13	37	HSB 614-11	36	HSB 931-08	84	HSC 241-15	59
HSB 101-13	38	HSB 615-11	36	HSB 935-12	84	HSC 243-15	62
HSB 102-14	37	HSB 648-10	46	HSB 942-09	47	HSC 244-18	59
HSB 103-14	38	HSB 649-10	46	HSB 942-11	47	HSC 250-17	48
HSB 104-15	37	HSB 650-10	46	HSB 942-13	47	HSC 251-17	48
HSB 105-15	38	HSB 651-10	46	HSB 943-09	47	HSC 252-17	48
HSB 106-16	37	HSB 653-10	46	HSB 943-11	47	HSC 253-17	48
HSB 107-16	38	HSB 659-12	46	HSB 943-13	47	HSC 501-00	62
HSB 108-18	37	HSB 664-11	46	HSB 945-11	47	HSC 510-16	61
HSB 109-18	38	HSB 665-11	46	HSB 946-14	47	HSC 511-16	61
HSB 113-12	39	HSB 704-10	83	HSB 948-13	47	HSC 512-10	61
HSB 120-14	39	HSB 705-11	83	HSB 948-14	47	HSC 513-10	61
HSB 121-14	39	HSB 706-12	83	HSB 950-12	47	HSC 514-10	61

Katalog-Nr. Cat. No.	Abb. auf Seite Illustr. on page	Katalog-Nr. Cat. No.	Abb. auf Seite Illustr. on page	Katalog-Nr. Cat. No.	Abb. auf Seite Illustr. on page	Katalog-Nr. Cat. No.	Abb. auf Seite Illustr. on page
HSC 524-16	63	HSC 826-20	65	HSE 092-18	77	HSL 132-20	81
HSC 525-30	63	HSC 831-10	65	HSE 093-18	77	HSL 246-15	107
HSC 530-30	63	HSC 832-11	65	HSE 094-20	77	HSL 252-15	107
HSC 533-12	61	HSC 833-13	65	HSE 095-20	77	HSL 252-20	107
HSC 534-12	61	HSC 834-14	65	HSE 308-09	80	HSL 510-17	46
HSC 535-11	61	HSC 835-16	65	HSE 772-20	79	HSL 512-17	46
HSC 550-10	63	HSC 836-20	65	HSE 773-20	79	HSL 516-14	46
HSC 551-10	63	HSC 837-25	65	HSE 774-25	79	HSL 520-06	73
HSC 552-11	63	HSC 838-30	65	HSE 775-25	79	HSL 521-71	73
HSC 553-11	63			HSE 786-25	79	HSL 522-00	73
HSC 554-13	63	<b>HSD</b>		HSE 900-16	77	HSL 522-01	73
HSC 555-13	63	HSD 005-14	78	HSE 902-18	77	HSL 522-02	73
HSC 556-14	63	HSD 009-14	78	HSE 904-20	77	HSL 522-03	73
HSC 557-14	63	HSD 430-10	74	HSE 906-18	78	HSL 522-04	73
HSC 559-10	63	HSD 431-11	74	HSE 908-20	78	HSL 522-05	73
HSC 561-11	63	HSD 432-12	74	HSE 910-16	78	HSL 522-06	73
HSC 563-13	63	HSD 433-13	74	HSE 914-15	78	HSL 522-07	73
HSC 565-14	63	HSD 434-14	74	HSE 916-19	78	HSL 522-08	73
HSC 570-11	63	HSD 435-15	74			HSL 563-00	73
HSC 571-12	63	HSD 436-16	74	<b>SHS</b>		HSL 660-21	103
HSC 572-13	63	HSD 446-10	74	SHS 098-00	6	HSL 668-20	103
HSC 573-14	63	HSD 447-11	74	SHS 101-00	6	HSL 669-18	103
HSC 574-16	63	HSD 448-12	74	SHS 102-00	6	HSL 670-12	103
HSC 575-20	63	HSD 449-13	74	SHS 106-00	6	HSL 671-25	103
HSC 600-11	52	HSD 450-14	74	SHS 563-00	6	HSL 672-25	103
HSC 601-11	52	HSD 451-15	74			HSL 673-12	103
HSC 602-11	52	HSD 452-16	74	<b>HSJ</b>		HSL 676-00	103
HSC 603-11	52	HSD 462-10	74	HSJ 001-06	68	HSL 678-00	103
HSC 604-11	52	HSD 463-11	74	HSJ 002-17	68	HSL 679-01	103
HSC 606-14	52	HSD 464-12	74	HSJ 003-23	68	HSL 680-02	103
HSC 607-12	52	HSD 465-13	74	HSJ 004-42	68	HSL 681-03	103
HSC 608-12	52	HSD 466-14	74	HSJ 005-43	68	HSL 684-01	103
HSC 609-12	52	HSD 467-15	74	HSJ 006-44	68	HSL 685-02	103
HSC 610-13	53	HSD 468-16	74	HSJ 043-05	69	HSL 686-03	103
HSC 611-13	53	HSD 478-10	74	HSJ 047-17	69	HSL 740-00	98
HSC 612-13	53	HSD 479-11	74	HSJ 048-02	69	HSL 750-00	107
HSC 613-12	53	HSD 480-12	74	HSJ 049-11	69	HSL 751-00	107
HSC 614-12	53	HSD 481-13	74	HSJ 101-00	104	HSL 958-01	101
HSC 615-12	53	HSD 482-14	74	HSJ 102-00	104	HSL 958-02	101
HSC 616-12	53	HSD 483-15	74	HSJ 103-00	104	HSL 964-00	101
HSC 617-12	53	HSD 484-16	74	HSJ 106-00	104	HSL 966-00	102
HSC 618-12	53			HSJ 109-01	104	HSL 967-00	102
HSC 700-93	64	<b>HSE</b>		HSJ 116-00	104	HSL 968-00	102
HSC 701-96	64	HSE 003-35	75	HSJ 130-03	104		
HSC 702-93	64	HSE 004-35	75	HSJ 131-04	104	<b>HSM</b>	
HSC 703-96	64	HSE 005-50	75	HSJ 132-05	104	HSM 004-14	99
HSC 800-10	65	HSE 006-50	75	HSJ 139-03	104	HSM 009-11	100
HSC 801-11	65	HSE 010-09	75	HSJ 140-04	104	HSM 012-11	99
HSC 802-13	65	HSE 011-09	75	HSJ 141-05	104	HSM 015-13	99
HSC 803-14	65	HSE 012-09	76	HSJ 146-04	104	HSM 022-12	99
HSC 804-16	65	HSE 013-09	76	HSJ 147-05	104	HSM 025-13	99
HSC 805-20	65	HSE 016-12	75	HSJ 149-03	104	HSM 031-12	99
HSC 807-10	65	HSE 017-12	75	HSJ 150-04	104	HSM 034-13	99
HSC 808-11	65	HSE 020-09	76	HSJ 151-05	104	HSM 060-00	98
HSC 809-13	65	HSE 021-09	76			HSM 076-10	99
HSC 810-14	65	HSE 022-12	76	<b>HSK</b>		HSM 079-11	99
HSC 811-16	65	HSE 023-12	76	HSK 069-03	104	HSM 081-11	100
HSC 812-20	65	HSE 024-14	76	HSK 069-04	104	HSM 084-09	100
HSC 813-25	65	HSE 025-14	76	HSK 069-05	104	HSM 145-01	60
HSC 814-30	65	HSE 062-13	76	HSK 069-06	104	HSM 190-01	105
HSC 816-10	62	HSE 063-13	76	HSK 115-00	23	HSM 191-00	105
HSC 816-13	62	HSE 064-14	76	HSK 116-01	23	HSM 220-00	106
HSC 816-16	62	HSE 065-14	76	HSK 117-02	23	HSM 221-00	106
HSC 817-10	62	HSE 066-16	76	HSK 480-01	99	HSM 222-18	106
HSC 817-13	62	HSE 067-16	76	HSK 481-01	99	HSM 223-00	106
HSC 817-16	62	HSE 069-18	76	HSK 650-23	40	HSM 230-14	105
HSC 818-11	64	HSE 070-18	76			HSM 231-23	105
HSC 819-10	64	HSE 071-20	76	<b>HSL</b>			
HSC 821-10	65	HSE 072-20	76	HSL 115-17	81	<b>HSN</b>	
HSC 822-11	65	HSE 086-14	77	HSL 121-18	81	HSN 001-10	12
HSC 823-13	65	HSE 087-14	77	HSL 122-16	81	HSN 002-13	12
HSC 824-14	65	HSE 088-16	77	HSL 128-00	98	HSN 003-15	12
HSC 825-16	65	HSE 089-16	77	HSL 130-17	81	HSN 006-10	12

Katalog-Nr. Cat. No.	Abb. auf Seite Illustr. on page	Katalog-Nr. Cat. No.	Abb. auf Seite Illustr. on page	Katalog-Nr. Cat. No.	Abb. auf Seite Illustr. on page	Katalog-Nr. Cat. No.	Abb. auf Seite Illustr. on page
HSN 007-13	12	HSN 152-13	26	HSN 291-17	22	HSN 823-01	109
HSN 008-15	12	HSN 152-17	22	HSN 293-20	22	HSN 826-01	109
HSN 008-15T	19	HSN 153-15	26	HSN 300-00	107	HSN 826-06	109
HSN 009-18	12	HSN 154-18	26	HSN 301-04	107	HSN 827-01	110
HSN 011-15	12	HSN 155-21	26	HSN 302-00	107	HSN 827-02	110
HSN 012-18	12	HSN 156-25	26	HSN 303-12	107	HSN 827-04	110
HSN 014-10	12	HSN 157-30	26	HSN 330-22	4	HSN 827-05	110
HSN 016-15	12	HSN 158-16	26	HSN 331-25	4	HSN 827-06	110
HSN 017-18T	19	HSN 159-15	26	HSN 332-30	4	HSN 827-07	110
HSN 018-21	12	HSN 160-17	26	HSN 333-40	4	HSN 827-10	110
HSN 021-13	12	HSN 161-16	26	HSN 334-50	4	HSN 827-12	110
HSN 022-15	12	HSN 162-23	26	HSN 335-60	4	HSN 827-15	110
HSN 023-18	12	HSN 167-15	27	HSN 338-55	4	HSN 830-01	109
HSN 024-21	12	HSN 167-15T	28	HSN 355-20	4		
HSN 028-15	12	HSN 168-18	27	HSN 356-22	4	<b>HSO</b>	
HSN 033-15	13	HSN 168-18T	28	HSN 357-25	4	HSO 001-10	94
HSN 034-18	13	HSN 169-21	27	HSN 358-30	4	HSO 095-10	80
HSN 036-13	13	HSN 169-21T	28	HSN 359-40	4	HSO 101-17	71
HSN 037-15	13	HSN 170-25	27	HSN 360-50	4	HSO 102-01	71
HSN 038-18	13	HSN 171-30	27	HSN 360-60	4	HSO 103-02	71
HSN 039-21	13	HSN 173-21	27	HSN 391-20	2	HSO 104-03	71
HSN 039-21T	19	HSN 174-25	27	HSN 392-25	2	HSO 106-01	71
HSN 042-13	13	HSN 175-30	27	HSN 393-30	2	HSO 107-02	71
HSN 043-15	13	HSN 176-40	27	HSN 400-15	16	HSO 108-03	71
HSN 044-18	13	HSN 179-19	27	HSN 401-21	16	HSO 119-00	90
HSN 045-21	13	HSN 180-15	27	HSN 403-12	27	HSO 122-00	89
HSN 047-13	13	HSN 180-18	27	HSN 403-12T	19	HSO 125-00	91
HSN 048-15	13	HSN 181-10	15	HSN 404-15	27	HSO 126-00	92
HSN 049-18	13	HSN 182-12	15	HSN 404-15T	19	HSO 128-00	93
HSN 050-21	13	HSN 183-15	15	HSN 405-18	27	HSO 130-00	95
HSN 053-13	13	HSN 184-18	15	HSN 405-18T	19	HSO 131-00	96
HSN 054-15	13	HSN 185-21	15	HSN 406-21	27	HSO 132-00	97
HSN 055-18	13	HSN 186-23	15	HSN 406-21T	19	HSO 135-12	86
HSN 056-21	13	HSN 187-26	15	HSN 407-25	27	HSO 138-62	86
HSN 060-10	13	HSN 190-10	15	HSN 408-30	27	HSO 139-64	86
HSN 061-15	13	HSN 191-12	15	HSN 410-20	28	HSO 140-65	86
HSN 062-18	13	HSN 192-15	15	HSN 411-17	28	HSO 141-67	86
HSN 063-21	13	HSN 193-18	15	HSN 412-17	28		
HSN 067-13	14	HSN 194-20	15	HSN 416-14	16	<b>HSR</b>	
HSN 068-15	14	HSN 195-23	15	HSN 417-16	16	HSR 550-00	104
HSN 069-18	14	HSN 196-26	15	HSN 418-21	16		
HSN 070-21	14	HSN 197-10	15	HSN 421-15	16	<b>HSS</b>	
HSN 075-15	14	HSN 197-15	15	HSN 422-18	16	HSS 001-00	105
HSN 075-15T	19	HSN 197-20	15	HSN 424-10	28	HSS 002-00	105
HSN 076-18	14	HSN 198-10	15	HSN 425-15	28	HSS 003-00	105
HSN 077-21	14	HSN 198-15	15	HSN 426-18	28	HSS 004-00	105
HSN 088-13	14	HSN 198-20	15	HSN 427-21	28	HSS 005-00	105
HSN 088-13T	19	HSN 200-08	20	HSN 430-10	16	HSS 006-00	105
HSN 089-15	14	HSN 201-10	20	HSN 431-15	16		
HSN 089-15T	19	HSN 202-13	20	HSN 432-20	16	<b>HSV</b>	
HSN 090-18	14	HSN 204-18	20	HSN 434-03	17	HSV 006-17	80
HSN 090-18T	19	HSN 205-21	20	HSN 435-04	17		
HSN 091-21	14	HSN 210-07	20	HSN 436-05	17	<b>HSZ</b>	
HSN 091-21T	19	HSN 211-10	20	HSN 437-06	17	HSZ 997-12	105
HSN 092-25	14	HSN 211-10T	21	HSN 443-10	16		
HSN 095-30	14	HSN 212-13	20	HSN 444-15	16	<b>HTC</b>	
HSN 096-35	14	HSN 212-13T	21	HSN 447-03	17	HTC 033-05	66
HSN 097-40	14	HSN 213-15	20	HSN 448-04	17	HTC 034-05	66
HSN 098-50	14	HSN 214-20	20	HSN 449-05	17	HTC 035-09	66
HSN 119-23	14	HSN 215-25	20	HSN 450-06	17	HTC 036-15	66
HSN 121-18	15	HSN 216-30	20	HSN 452-16	17	HTC 037-15	66
HSN 122-21	15	HSN 217-20	20	HSN 453-16	17	HTC 038-14	66
HSN 129-18	15	HSN 218-13	20	HSN 458-17	18	HTC 050-12	66
HSN 130-21	15	HSN 220-08	21	HSN 458-17T	18	HTC 052-13	66
HSN 133-15	22	HSN 221-10	21	HSN 459-19	28	HTC 054-16	66
HSN 134-18	22	HSN 222-13	21	HSN 461-22	18	HTC 057-16	66
HSN 135-21	22	HSN 225-08	21	HSN 462-22	18	HTC 080-20	67
HSN 136-23	22	HSN 226-10	21	HSN 463-18	18	HTC 081-20	67
HSN 139-15	22	HSN 227-13	21	HSN 463-18T	18	HTC 084-20	67
HSN 140-18	22	HSN 231-10	21	HSN 801-05	108	HTC 085-20	67
HSN 141-21	22	HSN 236-10	21	HSN 801-07	108	HTC 090-11	67
HSN 144-12	26	HSN 237-13	21	HSN 801-10	108	HTC 091-10	67
HSN 151-15	22	HSN 290-19	22	HSN 801-14	108		

Katalog-Nr. Cat. No.	Abb. auf Seite Illustr. on page	Katalog-Nr. Cat. No.	Abb. auf Seite Illustr. on page	Katalog-Nr. Cat. No.	Abb. auf Seite Illustr. on page	Katalog-Nr. Cat. No.	Abb. auf Seite Illustr. on page
<b>HWB</b>		<b>HWC</b>		<b>HWN</b>		<b>HWN</b>	
HWB 002-11	32	HWC 204-11	49	HWN 015-18	10	HWN 260-15	7
HWB 003-11	32	HWC 205-10	49	HWN 016-21	10	HWN 261-15	7
HWB 005-11	32	HWC 206-11	49	HWN 019-13	10	HWN 262-15	7
HWB 010-11	32	HWC 207-11	49	HWN 020-15	10	HWN 265-15	7
HWB 022-11	32	HWC 210-10	50	HWN 021-18	10	HWN 270-21	7
HWB 040-13	32	HWC 211-10	50	HWN 024-13	10	HWN 271-21	7
HWB 041-13	32	HWC 212-10	50	HWN 025-18	10	HWN 272-22	7
HWB 042-14	32	HWC 216-11	50	HWN 026-21	10	HWN 273-21	7
HWB 043-14	32	HWC 217-11	50	HWN 029-13	10	HWN 300-22	1
HWB 044-16	32	HWC 530-14	56	HWN 030-18	10	HWN 301-25	1
HWB 045-16	32	HWC 533-14	56	HWN 031-21	10	HWN 302-32	1
HWB 050-13	32	HWC 538-12	56	HWN 034-15	10	HWN 309-25	1
HWB 052-14	32			HWN 035-18	10	HWN 310-20	1
HWB 054-16	32	<b>HWH</b>		HWN 038-12	10	HWN 312-28	1
HWB 201-26	82	HWH 217-00	5	HWN 039-12	10	HWN 313-19	1
HWB 203-23	82	HWH 218-00	5	HWN 040-15	10	HWN 322-12	2
HWB 205-20	82	HWH 220-00	5	HWN 041-15	10	HWN 331-28	2
HWB 220-30	82	HWH 221-00	5	HWN 042-18	10	HWN 334-25	3
HWB 221-35	82	HWH 225-00	5	HWN 043-18	10	HWN 337-35	3
HWB 222-40	82	HWH 226-00	5	HWN 044-21	10	HWN 338-55	3
HWB 223-30	82	HWH 227-00	5	HWN 045-21	10		
HWB 224-35	82	HWH 228-00	5	HWN 046-24	10	<b>HWO</b>	
HWB 225-40	82			HWN 047-30	10	HWO 001-00	70
HWB 300-00	83	<b>HWJ</b>		HWN 050-21	10	HWO 002-00	70
		HWJ 008-17	68	HWN 051-18	10	HWO 003-00	70
		HWJ 011-16	68	HWN 052-15	10	HWO 004-00	70
		HWJ 015-09	68	HWN 055-15	11	HWO 005-01	70
		HWJ 091-00	104	HWN 056-18	11	HWO 007-02	70
				HWN 059-12	11	HWO 008-14	70
<b>HWC</b>		<b>HWK</b>		HWN 060-13	11	HWO 010-16	70
HWC 016-04	54	HWK 030-04	23	HWN 070-12	11	HWO 020-17	72
HWC 017-05	54	HWK 031-05	23	HWN 071-19	11	HWO 022-24	72
HWC 019-12	56	HWK 035-04	23	HWN 072-19	11	HWO 024-24	72
HWC 050-12	55	HWK 040-01	23	HWN 074-15	11	HWO 030-51	72
HWC 051-13	55	HWK 041-02	23	HWN 076-19	11	HWO 031-50	72
HWC 052-14	55	HWK 042-03	23	HWN 090-00	25	HWO 032-52	72
HWC 053-16	55	HWK 045-01	23	HWN 090-01	25	HWO 034-53	72
HWC 054-18	55	HWK 047-03	23	HWN 090-02	25	HWO 036-61	72
HWC 055-20	55			HWN 100-15	24	HWO 038-62	72
HWC 056-25	55	<b>HWL</b>		HWN 101-15	24	HWO 040-63	72
HWC 070-10	56	HWL 010-05	6	HWN 102-18	24	HWO 042-54	72
HWC 071-10	56	HWL 100-13	81	HWN 106-15	24	HWO 044-55	72
HWC 072-11	56	HWL 101-17	81	HWN 107-18	24	HWO 045-56	72
HWC 073-11	56	HWL 102-14	81	HWN 108-21	24	HWO 046-57	72
HWC 074-13	56	HWL 103-14	81	HWN 111-15	24	HWO 048-58	72
HWC 075-13	56	HWL 106-17	81	HWN 112-18	24	HWO 070-21	72
HWC 080-12	55			HWN 113-21	24	HWO 072-20	72
HWC 081-13	55	<b>HWM</b>		HWN 120-15	24	HWO 100-05	110
HWC 082-14	55	HWM 064-00	98	HWN 121-18	24	HWO 101-15	110
HWC 083-16	55	HWM 065-00	98	HWN 122-21	24	HWO 102-20	110
HWC 088-10	48	HWM 083-00	98	HWN 123-25	24		
HWC 102-09	56	HWM 084-00	98	HWN 124-30	24	<b>HWP</b>	
HWC 103-10	56	HWM 085-00	98	HWN 128-20	24	HWP 026-10	69
HWC 104-11	56	HWM 087-10	98	HWN 130-15	24	HWP 027-15	69
HWC 110-10	48	HWM 088-25	98	HWN 131-18	24	HWP 028-20	69
HWC 111-10	48	HWM 200-11	100	HWN 132-21	24	HWP 029-10	69
HWC 112-10	48	HWM 201-09	100	HWN 133-25	24	HWP 030-15	69
HWC 115-10	48			HWN 134-30	24		
HWC 116-10	51	<b>HWN</b>		HWN 141-14	25		
HWC 118-10	51	HWN 001-02	8	HWN 143-19	25		
HWC 130-15	54	HWN 002-03	8	HWN 144-20	25		
HWC 131-12	54	HWN 003-04	8	HWN 147-15	25		
HWC 132-14	54	HWN 004-05	8	HWN 150-01	9		
HWC 133-16	54	HWN 005-03	8	HWN 150-02	9		
HWC 134-12	54	HWN 006-04	8	HWN 150-03	9		
HWC 135-14	54	HWN 007-05	8	HWN 150-04	9		
HWC 136-16	54	HWN 008-04	8	HWN 150-05	9		
HWC 144-16	55	HWN 009-05	8	HWN 250-18	7		
HWC 145-16	55	HWN 010-00	8	HWN 251-20	7		
HWC 147-10	55	HWN 011-18	17	HWN 252-22	7		
HWC 148-16	55	HWN 012-18	17	HWN 253-25	7		
HWC 149-16	55	HWN 013-12	10	HWN 254-27	7		
HWC 200-10	49	HWN 014-15	10	HWN 255-29	7		
HWC 201-10	49						
HWC 202-10	49						
HWC 203-11	49						



Solingen



Abfüllschaufel	28	Glasmörser	107
Abnehmer, Skalpellklingen-	83	Glasplatte	107
Abstrichösen	72	Glasspatel	6
Achatspatel	6	<b>Goldman-Fox mod.</b> Präparierscheren	36
<b>Adson</b> Hakenpinzetten	59	<b>Goldman-Fox</b> Präparierscheren	36, 42
<b>Adson</b> Pinzetten	58	Greifpinzetten	56, 63
<b>Adson-Brown</b> Hakenpinzetten	59	Griffe, Skalpell-	83-88
Allzweckscheren	45	Griffe, Spiegel-	104
Anmischbecher	98	<b>Gross-Maier</b> Fass- und Kornzangen	79
Anmischplatten	98	Haarpinzetten	60
Apothekerlöffel	26	Haken- Muskel-	80
Apothekerspatel	20, 21	Hakenmuffen	109
Arbeitsscheren	44, 47	Hakenpinzetten	59, 62
<b>Baby Metzenbaum</b> Präparierscheren	39	<b>Halsted-Mosquito</b> Schlauchklemmen	76
<b>Baby-Mosquito</b> Schlauchklemmen	76	Halter, Nadel-	78
Basis Tierexperimentier-Set	90	Halter, Nadel- für Abstrichösen und Präpariernadeln	72
Behälter, Sicherheits- für Sondermüll	106	Halter, Pinsel-	73
Besteck, Biologen-	93	Halter, Reagenzglas-	2
Besteck, Chemiker-	96	Halterung für Pinsel	73
Besteck, Chemiker- (groß)	92	Haltezangen für Isotopenfläschchen	3
Besteck, Chemiker- (klein)	91	Haltezangen, Universal-	1
Besteck, Mikroskopie-	94	Hammer, Niet-	103
Besteck, Mikroskopier-	89	Handwaschbürsten	105
Besteck, Studenten-	95	Heber, Schnitt-	7
Biologenbesteck	93	Hohlmeißelzangen	99
Blechscheren	46	<b>Hünebeck</b> Universalhalte-zangen	1
Brenngutträgerpinzetten	63	Industrieklingen	88
Bügelklingen	87, 88	Inzisionsscheren	40, 47
Bürsten, Handwasch-	105	<b>Kelly</b> Präparierscheren	43
Bürsten, Kunststoff-	105	<b>Killner/Ragnell</b> Präparierscheren	39
Chemikalienlöffel	24, 26	Klemmen, Fass-	80
Chemikerbesteck	96	Klemmen, Gefäß-	75
Chemikerbesteck, groß	92	Klemmen, Mikro-	75
Chemikerbesteck, klein	91	Klemmen, Schlauch-	76-78
Chirurgische Nadeln	74	Klemmen, Stativ-	109
<b>College</b> Titan-Pinzetten	66	Klingen für Folienmesser	86
Deckglaspinzetten	55, 61, 62	Klingen, Bügel-	87, 88
Doppellöffel	24	Klingen, Industrie-	88
Doppelspatel	10, 14-16, 19, 22	Klingen, Mikro-Skalpell-	86
Doppelspatel, Mikro-	11-13, 16	Klingen, Rasier-	83
Dosierspatel	18	Klingen, Schaber-	87
Drahtscheren	45, 46	Klingen, Skalpell-	83-85
Drigalski-Spatel	11	Klingen, Trapez- für Sicherheitsmesser	87
Einmalskalpelle	85	Knochenscheren	40
Einwiegelöffel	24, 25	Knochensplitterzangen	99
Einwiegespatel	10	Knopfsonden	69
Einwiegespatel, Mikro-	10	<b>Kocher (Ochsner)</b> Schlauchklemmen	76
Fadenscheren	32	Korkmesser	81
<b>Fahnenstock</b> Labormesser	81	Kornzangen	79
<b>Fahnenstock</b> Wachsmesser	81	Kreuzpinzetten	61
Färbepinzetten	57	Kunststoffbürsten	105
Fassklemmen	80	Kunststoffspatel	106
Fasspinzetten für Gewebe und Tumore	64	Küvettenzangen	4
Fasspinzetten, Präparaten-	60	Laborlöffel	25, 26
Fasszangen	79	Labormesser	81
Fasszangen, Spezial-	2	Laborspatel	54, 55
Finder	71	Laborscheren	44, 45
<b>Foerster</b> Sterilisierzangen	79	Laborspatel	9, 22
Folienmesser	86, 88	<b>LaGrange</b> Präparierscheren	36, 42
Folienscheren	34	Lampe, Spiritus-	107
Gefäßklemmen	75	Laubsägebögen	103
Gefäßscheren	32	Leichtpinzetten	51
<b>Geppert</b> Greifpinzetten	63	Lineal, Mess-	107
<b>Gerald</b> Mikropinzetten	48	<b>Lister</b> Laborscheren	44
Gewebescheren	100	Löffel- und Spatelset	97
Gewebescheren, Mikro-	31	Löffel, Apotheker-	26
Gewebezangen	100	Löffel, Chemikalien-	24, 26
Glasblock	107	Löffel, Doppel-	24



Löffel, Einwiege-	24, 25	Nierenschalen	98
Löffel, Labor-	25, 26	Niethammer	103
Löffel, Mikro-	17, 24, 25	Offene Löffel	28
Löffel, Offen	28	Ohrlochzangen	80
Löffel, Poly-	27, 28	Ohrpinzetten	64
Löffel-Spatel	19, 24, 27	Ölstift	105
Löffelspatel, Mikro-	13, 28	Ösen	72
<b>London-College</b> Pinzetten, einfache Ausführung	64	Ösen, Abstrich-	72
<b>London-College</b> Titan-Pinzetten	66	<b>Pean</b> Schlauchklemmen	76
Lötpinzetten	55	Pedikürezangen	99
<b>Lucae</b> Ohrpinzetten	64	Pinselfalter	73
<b>Mathieu</b> Nadelhalter	78	Pinselföpfe	73
Matte, Schneid-	105 oder 106	Pinzetten, Brenngutträger-	63
<b>Mayo</b> Scheren	40	Pinzetten, Deckglas-	55, 61, 62
<b>Meriam</b> Pinzetten, einfache Ausführung	64	Pinzetten, einfache Ausführung	65
<b>Meriam</b> Titan-Pinzetten	66	Pinzetten, Färbe-	57
Meßbecher	98	Pinzetten, Fass- für Gewebe und Tumore	64
Messer, Folien-	86, 88	Pinzetten, Greif-	56, 63
Messer, Kork-	81	Pinzetten, Haar-	60
Messer, Labor-	81	Pinzetten, Haken-	59, 62
Messer, Präparier-	82	Pinzetten, Kreuz-	61
Messer, Schaumstoff-	88	Pinzetten, Labor-	54, 55
Messer, Sicherheits-	87	Pinzetten, Leicht-	51
Messer, Spatel-	7, 21	Pinzetten, Löt-	55
Messer, Wachs-	81	Pinzetten, Mikro-	48-53
Messlineal	107	Pinzetten, Mikro-Präparier-	48
Messschieber, Taschen- (digital)	107	Pinzetten, mikroskopisch	56, 63
<b>Metzenbaum fino</b> Präparierscheren	39, 41	Pinzetten, Nadel-	57
<b>Micro-Adson</b> Mikropinzetten	51	Pinzetten, Ohr-	64
<b>Micro-Halsted</b> Mikroklemmen	75	Pinzetten, Präparaten-Fass-	60
<b>Micro-Hartmann</b> Mikroklemmen	75	Pinzetten, Präparier-	56, 60
Mikro-Doppelspatel	11-13, 16	Pinzetten, schneidend	48
Mikro-Einwiegespatel	10	Pinzetten, Spezial-	53
Mikro-Gewebescheren	31	Pinzetten, Splitter-	60
Mikroklemmen	75	Pinzetten, teflonbeschichtet	63
Mikrolöffel	17, 24, 25	Pinzetten, Titan-	66, 67
Mikro-Löffelspatel	13, 28	Pinzetten, Uhrmacher-	64
Mikropinzetten	48-53	Pinzettenständer	101
Mikropistill	110	Pistill, Mikro-	110
Mikro-Präparierpinzetten	48	Polylöffel	27, 28
Mikro-Präparierscheren	32	Präparaten-Fasspinzetten	60
Mikro-Präpariersonden	68	Präpariermesser	82
Mikro-Pulverspatel	8, 12, 13, 17	Präpariernadeln	70, 71
Mikroscheren	29-31	Präparierpinzetten	56, 60
Mikro-Skalpellklingen	86	Präparierpinzetten, Mikro-	48
Mikroskopiebesteck	94	Präparierscheren	30, 34-36, 39, 41-43
Mikroskopierbesteck	89	Präparierscheren TC	41
Mikroskopische Pinzetten	56, 63	Präparierscheren, Mikro-	32
Mikrospatel	7, 8, 10, 13, 15-17, 19	Präpariersonden	69
<b>Mini-Friedman</b> Hohlmeißelzangen	99	Präpariersonden, Mikro-	68
Mischspatel	5-7, 11, 22	Propellerrührköpfe	108
Modellsägeblätter	103	Pufferzangen	99
Modellsägen	103	Pulverspatel	14, 19
Mörser, Glas-	107	Pulverspatel, Mikro-	8, 12, 13, 17
Muffelzangen, Spezial-	3	Rasierklingen	83
Muffen, Haken-	109	Reagenzglashalter	2
Multifunktionsscheren	45	Reagenzglasständer	102
Muskelhaken	80	Ringe, Stativ-	109
Nadelhalter	78	Rührköpfe, Propeller-	108
Nadelhalter für Abstrichösen und Präpariernadeln	72	Sägeblätter	103
Nadeln	72	Sägeblätter, Modell-	103
Nadeln, chirurgisch	74	Sägen, Modell-	103
Nadeln, Präparier-	70, 71	Schaber	87, 88
Nadelpinzetten	57	Schaberklingen	87
Nagelreiniger	100	Schaukel, Abfüll-	28
Nagelscheren	100	Schaumstoffmesser	88
Nagelzangen	99	Scheren für Linkshänder	36
Nahtscheren	40	Scheren für Mikroskopie	33, 34, 47



Scheren für Physiologie	32	Spatel, Mikro-Einwiege-	10
Scheren, Allzweck-	45	Spatel, Mikro-Löffel-	13, 28
Scheren, Arbeits-	44, 47	Spatel, Mikro-Pulver-	8, 12, 13, 17
Scheren, Blech-	46	Spatel, Misch-	5-7, 11, 22
Scheren, Draht-	45, 46	Spatel, Pulver-	14, 19
Scheren, Faden-	32	Spatel, Separier-	5
Scheren, Folien-	34	Spatel, Vibrations-	18
Scheren, Gefäß-	32	Spatelmesser	7, 21
Scheren, Gewebe-	100	<b>Spencer</b> Nahtscheren	40
Scheren, Inzisions-	40, 47	Spezialfaßzangen	2
Scheren, Knochen-	40	Spezialmuffelzangen	3
Scheren, Labor-	44, 45	Spezialpinzetten	53
Scheren, Mikro-	29-31	Spiegel	104
Scheren, Mikro-Gewebe-	31	Spiegelgriffe	104
Scheren, Mikro-Präparier-	32	Spirituslampe	107
Scheren, Multifunktions-	45	Spitzenschutz	105
Scheren, Nagel-	100	Splitterpinzetten	60
Scheren, Naht-	40	<b>Standard Grazil</b> Präparierscheren	42
Scheren, Präparier-	30, 34-36, 39, 41-43	<b>Standard</b> Laborpinzetten	54, 55
Scheren, Präparier- TC	41	<b>Standard</b> Präparierscheren	43
Scheren, Taschen-	47	<b>Standard</b> Scheren	37, 38, 41
Scheren, TC	41	Ständer, Pinzetten-	101
Scheren, Universal-	44	Ständer, Reagenzglas-	102
Schlauchklemmen	76-78	Ständer, Zangen-	101
Schneidende Pinzetten	48	Standgefäße	98
Schneidmatte	105 oder 106	Stangen, Stativ-	110
Schnittfänger	16	Stanzen, grazil	104
Schnittheber	7	Stativklemmen	109
Schreibdiamant	103	Stativringe	109
<b>Semken</b> Hakenpinzetten	59	Stativstangen	110
<b>Semken</b> Pinzetten	58, 59	Sterilisierzangen	79
Separierspatel	5	Studentenbesteck	95
Set, Basis Tierexperimentier-	90	Taschen-Messschieber, digital	107
Set, Biologen-	93	Taschenscheren	47
Set, Chemiker-	96	<b>Taylor</b> Pinzetten	59
Set, Chemiker- (groß)	92	Tiegelzangen	1, 2, 4
Set, Chemiker- (klein)	91	Tierexperimentier-Set, Basis	90
Set, Löffel- und Spatel-	97	Titan-Pinzetten	66, 67
Set, Mikroskopie-	94	Trapezklingen für Sicherheitsmesser	87
Set, Mikroskopier-	89	Uhrmacherpinzetten	64
Set, Studenten-	95	Universalhalte-zangen	1
Sicherheitsbehälter für Sondermüll	106	Universalscheren	44
Sicherheitsmesser	87	Universalzangen	100
Sicherheits-Skalpellgriffe	86	Vibrationsspatel	18
Skalpelle	82, 85	Wachsmesser	81
Skalpelle, Einmal-	85	<b>Waugh</b> Pinzetten	58
Skalpelligriffe	83-86	<b>Waugh</b> Präparaten-Fasspinzetten	60
Skalpelloklingen	83-85	Zangen, Fass-	79
Skalpelloklingen, Mikro-	86	Zangen, Gewebe-	100
Skalpelloklingen-Abnehmer	83	Zangen, Halte- für Isotopenflaschen	3
Sonden	68	Zangen, Hohlmeißel-	99
Sonden, Knopf-	69	Zangen, Knochensplitter-	99
Sonden, Mikro-Präparier-	68	Zangen, Korn-	79
Sonden, Präparier-	69	Zangen, Küvetten-	4
Spatel	6	Zangen, Nagel-	99
Spatel- und Löffelset	97	Zangen, Ohrloch-	80
Spatel, Achat-	6	Zangen, Pediküre-	99
Spatel, Apotheker-	20, 21	Zangen, Puffer-	99
Spatel, Doppel-	10, 14-16, 19, 22	Zangen, Spezialfaß-	2
Spatel, Dosier-	18	Zangen, Spezialmuffel-	3
Spatel, Drigalski-	11	Zangen, Sterilisier-	79
Spatel, Einwiege-	10	Zangen, Tiegel-	1, 2, 4
Spatel, Glas-	6	Zangen, Universal-	100
Spatel, Kunststoff-	106	Zangen, Universalhalte-	1
Spatel, Labor-	9, 22	Zangenständer	101
Spatel, Löffel-	19, 24, 27		
Spatel, Mikro-	7, 8, 10, 13, 15-17, 19		
Spatel, Mikro-Doppel-	11-13, 16		



<b>Adson</b> Forceps	58, 59	Ear puncher	80
<b>Adson-Brown</b> Forceps	59	Experiments set, Basic animal	90
Agate spatulas	6	<b>Fahnenstock</b> Laboratory knives	81
Alcohol burners	107	<b>Fahnenstock</b> Wax knives	81
All-purpose scissors	45	Foam knives	88
Animal experiments set, Basic	90	<b>Foerster</b> Sterilizing forceps	79
Artery sissors	32	Foil knives	86, 88
Aseptic nail brush	105	Foil scissors	34
<b>Baby Metzenbaum</b> Dissecting scissors	39	Forceps for taking hold of tumours and tissue	64
<b>Baby Mosquito</b> Tubing clamps	76	Forceps for watch-makers	64
Basic animal experiments set	90	Forceps stand	101
Biologist set	93	Forceps, Bone cutting	99
Blades for foil knives	86	Forceps, Cover glass	55, 61, 62
Blades, Bow	87, 88	Forceps, Cutting	48
Blades, Industrial	88	Forceps, Dissecting	56, 60
Blades, Micro scalpel	86	Forceps, Dressing	79
Blades, Razor	83	Forceps, Ear	64
Blades, Saw	103	Forceps, Grasping	56, 63, 79
Blades, Scalpel	83-85	Forceps, Hair	60
Blades, Scraper	87	Forceps, Laboratory	54, 55
Blades, Trapezoid (for safety knives)	87	Forceps, Light	51
Bone cutting forceps	99	Forceps, Micro	48-53, 75
Bone shears	40	Forceps, Micro dissecting	48
Bow blades	87, 88	Forceps, Microscopic	56, 63
Bowls, Kidney	98	Forceps, Needle	57
Bowls, Mixing	98	Forceps, Self-locking	61
Brush heads	73	Forceps, Simple type	65
Brush holders	73	Forceps, Special	53
Brush station	73	Forceps, Special grasping	2
Brush, Plastic	105	Forceps, Specimen seizing	60
Bulb tongs	4	Forceps, Splinter	60
Burners, Alcohol	107	Forceps, Staining	57
Caliper, Pocket (digital)	107	Forceps, Sterilizing	79
Chemist's set	96	Forceps, Teflon coated	63
Chemist's set, large	92	Forceps, Tissue	59, 62, 100
Chemist's set, small	91	Forceps, Titanium	66, 67
Chemist's spatulas	20, 21	Forceps, Universal	100
Chemist's spoons	26	Fret saw frames	103
Clamps, Grasping	80	Fuel carrier pincers	63
Clamps, Stand	109	<b>Geppert</b> Grasping forceps	63
Clamps, Tubing	76-78	<b>Gerald</b> Micro forceps	48
<b>College</b> Titanium forceps	66	Glass mortar	107
Container, Safety for special waste	106	Glass slabs	107
Cork knives	81	Glass spatulas	6
Cover glass forceps	55, 61, 62	<b>Goldman-Fox</b> Dissecting scissors	36, 42
Crucible tongs	1-4	<b>Goldman-Fox mod.</b> Dissecting scissors	36
Crucible tongs, Special	3	Grasping clamps	80
Cutting forceps	48	Grasping forceps	56, 63, 79
Cutting mat	105 oder 106	Grasping forceps, Special	2
Disposable scalpels	85	<b>Gross-Maier</b> Grasping and dressing forceps	79
Dissecting forceps	56, 60	Hair forceps	60
Dissecting forceps, Micro	48	<b>Halsted-Mosquito</b> Tubing clamps	76
Dissecting needles	70, 71	Hammer, Riveting	103
Dissecting probes	69	Handles, Mirror	104
Dissecting probes, Micro	68	Handles, Scalpel	83-88
Dissecting scissors	30, 34-36, 39, 41-43	Holder, Needle	78
Dissecting scissors TC	41	Holder, Needle (for specimen loops and dissecting needles)	72
Dissecting scissors, Micro	32	Holder, Test tube	2
Dissecting set, Microscopic	89	Holders, Brush	73
Dissecting tenaculum	80	Holding tongs for litte isotop bottles	3
Double ended spatulas	10, 14-16, 19, 22	Holding tongs, Universal	1
Dressing forceps	79	Hook sleeves	109
Drigalski spatulas	11	<b>Hünebeck</b> Universal holding tongs	1
Ear forceps	64	Incision scissors	40, 47



Industrial blades	88	Multifunctional scissors	45
Jars	98	Nail brush, Aseptic	105
<b>Kelly</b> Dissecting scissors	43	Nail cleaner	100
Kidney bowls	98	Nail nippers	99
<b>Killner/Ragnell</b> Dissecting scissors	39	Nail nippers with buffers	99
Knives, Cork	81	Nail nippers, Pedicure	99
Knives, Foil	86, 88	Nail scissors	100
Knives, Laboratory	81	Needle forceps	57
Knives, Preparation	82	Needle holder	78
Knives, Safety	87	Needle holder for specimen loops and dissecting needles	72
Knives, Wax	81	Needles	72
Knives, Foam	88	Needles, Dissecting	70, 71
<b>Kocher (Ochsner)</b> Tubing clamps	76	Needles, Suture	74
Laboratory forceps	54, 55	Nippers, Nail	99
Laboratory knives	81	Nippers, Nail with buffers	99
Laboratory scissors	44, 45, 47	Nippers, Pedicure nail	99
Laboratory spatulas	9, 22	Oil pens	105
Laboratory spoons	25, 26	Open spoons	28
<b>LaGrange</b> Dissecting scissors	36, 42	<b>Pean</b> Tubing clamps	76
Ligature scissors	32	Pedicure nail nippers	99
Light forceps	51	Pestles, Micro	110
<b>Lister</b> Laboratory scissors	44	Pincers, Fuel carrier	63
<b>London-College</b> Forceps, simple type	64	Plastic brush	105
<b>London-College</b> Titanium forceps	66	Plastic spatulas	106
Loops	72	Plate shears	46
Loops, Specimen	72	Pocket caliper, digital	107
<b>Lucae</b> Ear forceps	64	Pocket scissors	47
Mat, Cutting	105 oder 106	Poly spoons	27, 28
<b>Mathieu</b> Needle holder	78	Powder spatulas	14, 19
<b>Mayo</b> Scissors	40	Powder spatulas, Micro	8, 12, 13, 17
Measuring cups	98	Preparation knives	82
Measuring rulers	107	Probes	68, 69
<b>Meriam</b> Forceps, simple type	64	Probes, Dissecting	69
<b>Meriam</b> Titanium forceps	66	Probes, Micro dissecting	68
<b>Metzenbaum fino</b> Dissecting scissors	39, 41	Propeller stirring heads	108
Micro dissecting forceps	48	Puncher, Ear	80
Micro dissecting probes	68	Punches	104
Micro dissecting scissors	32	Rack for test tubes	102
Micro dissecting set	94	Razor blades	83
Micro forceps	48-53, 75	Remover, Scalpel blade	83
Micro pestles	110	Rings, Stand	109
Micro powder spatulas	8, 12, 13, 17	Riveting hammer	103
Micro scalpel blades	86	Rods, Stand	110
Micro scissors	29-31	Rongeurs	99
Micro spatulas	7, 8, 10, 13, 15-17, 19	Rulers, Measuring	107
Micro spatulas, double ended	11-13, 16	Safety container for special waste	106
Micro spoon spatulas	13, 28	Safety knives	87
Micro spoons	17, 24, 25	Safety scalpel handles	86
Micro tissue scissors	31	Saw blades	103
Micro weighing spatulas	10	Saws, Model	103
<b>Micro-Adson</b> Micro forceps	51	Scalpel blade remover	83
<b>Micro-Halsted</b> Micro forceps	75	Scalpel blades	83-85
<b>Micro-Hartmann</b> Micro forceps	75	Scalpel blades, Micro	86
Microscopic dissecting set	89	Scalpel blades, Safety	86
Microscopic forceps	56, 63	Scalpels	82, 85
Microscopic scissors	33, 34, 47	Scalpels, Disposable	85
<b>Mini-Friedman</b> Rongeurs	99	Scapel handles	83-86
Mirror handles	104	Scissors for left-handers	36
Mirrors	104	Scissors für physiology	32
Mixing bowls	98	Scissors, All-purpose	45
Mixing pallets	98	Scissors, Artery	32
Mixing spatulas	5-7, 11, 22	Scissors, Dissecting	30, 34-36, 39, 41-43
Model saws	103	Scissors, Dissecting TC	41
Mortar, Glass	107	Scissors, Foil	34



Scissors, Incision	40, 47	Spoon and spatula set	97
Scissors, Laboratory	44, 45, 47	Spoons for chemicals	24, 26
Scissors, Ligature	32	Spoons, Chemist's	26
Scissors, Micro	29-31	Spoons, double ended	24
Scissors, Micro dissecting	32	Spoons, Laboratory	25, 26
Scissors, Micro tissue	31	Spoons, Micro	17, 24, 25
Scissors, Microscopic	33, 34, 47	Spoons, Open	28
Scissors, Multifunctional	45	Spoons, Poly	27, 28
Scissors, Nail	100	Spoons, Weighing	24, 25
Scissors, Pocket	47	Spoon-spatulas	19, 24, 27
Scissors, Suture	40	Spoon-spatulas, Micro	13, 28
Scissors, TC	41	Staining forceps	57
Scissors, Tissue	100	Stand clamps	109
Scissors, Universal	44	Stand rings	109
Scraper	87, 88	Stand rods	110
Scraper blades	87	<b>Standard</b> Dissecting scissors	43
Section lifter	7, 16	<b>Standard Brazil</b> Dissecting scissors	42
Seeker	71	<b>Standard</b> Laboratory forceps	54, 55
Seizing forceps, Specimen	60	<b>Standard</b> Scissors	37, 38, 41
<b>Semken</b> Forceps	58, 59	Stands for forceps	101
Separating spatulas	5	Stands for tweezers	101
Serrefines	75	Sterilizing forceps	79
Set for students	95	Stirring heads, Propeller	108
Set, Basic animal experiments	90	Suture needles	74
Set, Biologist	93	Suture scissors	40
Set, Chemist	96	<b>Taylor</b> Forceps	59
Set, Chemist (large)	92	Tenaculum, Dissecting	80
Set, Chemist (small)	91	Test tube holder	2
Set, Micro dissecting	94	Test tube rack	102
Set, Microscopic dissecting	89	Tip protection	105
Set, Spoon and spatula	97	Tissue forceps	59, 62, 100
Shears, Bone	40	Tissue scissors	100
Shears, Plate	46	Tissue scissors, Micro	31
Shears, Wire	45, 46	Titanium forceps	66, 67
Shovels, Weighing	28	Tongs, Bulb	4
Sleeves, Hook	109	Tongs, Crucible	1, 2, 4
Soldering tweezers	55	Tongs, Holding for litte isotop bottles	3
Spatula and spoon set	97	Tongs, Special Crucible	3
Spatula knives	7, 21	Tongs, Universal holding	1
Spatulas, Agate	6	Trapezoid blades for safety knives	87
Spatulas, Chemist's	20, 21	Tubing clamps	76-78
Spatulas, double ended	10, 14-16, 19, 22	Tweezers stand	101
Spatulas, Drigalski	11	Tweezers, Soldering	55
Spatulas, Glass	6	Universal forceps	100
Spatulas, Laboratory	9, 22	Universal holding tongs	1
Spatulas, Micro	7, 8, 10, 13, 15-17, 19	Universal scissors	44
Spatulas, Micro powder	8, 12, 13, 17	Vibration spatulas	18
Spatulas, Micro spoon	13, 28	Watch maker forceps	64
Spatulas, Micro Weighing	10	<b>Waugh</b> Forceps	58
Spatulas, Micro, double ended	11-13, 16	<b>Waugh</b> Specimen seizing forceps	60
Spatulas, Mixing	5-7, 11, 22	Wax knives	81
Spatulas, Plastic	106	Weighing spatulas	10
Spatulas, Powder	14, 19	Weighing spatulas, Micro	10
Spatulas, Separating	5	Weighing spoons	24, 25
Spatulas, Spoon	19, 24, 27	Weighung shovels	28
Spatulas, Vibration	18	Wire shears	45, 46
Spatulas, Weighing	10	Writing diamonds	103
Special crucible tongs	3		
Special forceps	53		
Special grasping forceps	2		
Speciman loops	72		
Specimen seizing forceps	60		
<b>Spencer</b> Suture scissors	40		
Splinter forceps	60		

## По вопросам продаж и поддержки обращайтесь:

Алматы (727)345-47-04  
Ангарск (3955)60-70-56  
Архангельск (8182)63-90-72  
Астрахань (8512)99-46-04  
Барнаул (3852)73-04-60  
Белгород (4722)40-23-64  
Благовещенск (4162)22-76-07  
Брянск (4832)59-03-52  
Владивосток (423)249-28-31  
Владикавказ (8672)28-90-48  
Владимир (4922)49-43-18  
Волгоград (844)278-03-48  
Вологда (8172)26-41-59  
Воронеж (473)204-51-73  
Екатеринбург (343)384-55-89

Иваново (4932)77-34-06  
Ижевск (3412)26-03-58  
Иркутск (395)279-98-46  
Казань (843)206-01-48  
Калининград (4012)72-03-81  
Калуга (4842)92-23-67  
Кемерово (3842)65-04-62  
Киров (8332)68-02-04  
Коломна (4966)23-41-49  
Кострома (4942)77-07-48  
Краснодар (861)203-40-90  
Красноярск (391)204-63-61  
Курск (4712)77-13-04  
Курган (3522)50-90-47  
Липецк (4742)52-20-81

Магнитогорск (3519)55-03-13  
Москва (495)268-04-70  
Мурманск (8152)59-64-93  
Набережные Челны (8552)20-53-41  
Нижний Новгород (831)429-08-12  
Новокузнецк (3843)20-46-81  
Ноябрьск (3496)41-32-12  
Новосибирск (383)227-86-73  
Омск (3812)21-46-40  
Орел (4862)44-53-42  
Оренбург (3532)37-68-04  
Пенза (8412)22-31-16  
Петрозаводск (8142)55-98-37  
Псков (8112)59-10-37  
Пермь (342)205-81-47

Ростов-на-Дону (863)308-18-15  
Рязань (4912)46-61-64  
Самара (846)206-03-16  
Санкт-Петербург (812)309-46-40  
Саратов (845)249-38-78  
Севастополь (8692)22-31-93  
Саранск (8342)22-96-24  
Симферополь (3652)67-13-56  
Смоленск (4812)29-41-54  
Сочи (862)225-72-31  
Ставрополь (8652)20-65-13  
Сургут (3462)77-98-35  
Сыктывкар (8212)25-95-17  
Тамбов (4752)50-40-97  
Тверь (4822)63-31-35

Тольятти (8482)63-91-07  
Томск (3822)98-41-53  
Тула (4872)33-79-87  
Тюмень (3452)66-21-18  
Ульяновск (8422)24-23-59  
Улан-Удэ (3012)59-97-51  
Уфа (347)229-48-12  
Хабаровск (4212)92-98-04  
Чебоксары (8352)28-53-07  
Челябинск (351)202-03-61  
Череповец (8202)49-02-64  
Чита (3022)38-34-83  
Якутск (4112)23-90-97  
Ярославль (4852)69-52-93

**Россия** +7(495)268-04-70

**Казахстан** +7(727)345-47-04

**Беларусь** +(375)257-127-884

**Узбекистан** +998(71)205-18-59

**Киргизия** +996(312)96-26-47

эл.почта: [hqs@nt-rt.ru](mailto:hqs@nt-rt.ru) || сайт: <https://hammacher.nt-rt.ru/>